

SIPROTEC4

Multifunction protection with
control
7SJ61/62/63

Input/Output unit with local
control
6MD63

Multifunctional machine
protection
7UM61

Communication module

PROFIBUS-DP
Communication profile

Preface

Bus specific parameters

1

Execution of switching operations via
PROFIBUS-DP

2

Response in the event of disturbed
communication to the PROFIBUS-
DP master

3

Annunciations to the PROFIBUS-DP
master

4

Data type definitions

5

PROFIBUS-DP – Parameterization
in DIGSI

6

Hardware interface

7

Glossary

Index

Revision: 1.0

Edition: September 2000

C53000-L1840-B001-02

Non-liability clause

Although we have checked the contents of this publication for conformance with the hardware and software described we cannot guarantee complete conformance since differences cannot be ruled out.

The information in this manual is checked at regular intervals and necessary corrections are included in the next releases.

Your suggestions are welcome.

Subject to change without prior notice.

Copyright

Copyright © Siemens AG 2000. All rights reserved.

Passing on or reproduction of this document, utilization and revelation of its contents is not permitted without express permission. Violations shall be cause for damage claims.

All rights reserved, in particular when a patent is issued or a general model registered.

Registered trademarks

SIPROTEC® und DIGSI® are registered trademarks of Siemens AG. Other designations in this manual may be trademarks that if used by third parties for their own purposes may violate the rights of the owner.

Preface

Contents of this manual

The manual is divided into the following topics:

- Bus specific parameters
- Execution of switching operations via PROFIBUS-DP
- Response in the event of disturbed communication to the PROFIBUS-DP master
- Data type definitions
- PROFIBUS-DP – Parameterization in DIGSI
- Hardware interface

Additional literature

This manual describes the bus specific parameters of the PROFIBUS-DP slave of the SIPROTEC devices 7SJ61, 7SJ62, 7SJ63, 6MD63 and 7UM61.

The following additional manuals inform you about the data in the PROFIBUS-DP messages and the function, operation, assembly and commissioning of the SIPROTEC devices:

<i>Manual</i>	<i>Contents</i>	<i>Order number</i>
Overcurrent, overload and motor protection with control SIPROTEC 7SJ61	Function, operation, assembly and commissioning of the SIPROTEC device 7SJ61	C53000-G1140-C118-2
Multifunction protection with control SIPROTEC 7SJ62	Function, operation, assembly and commissioning of the SIPROTEC device 7SJ62	C53000-G1140-C121-2
Multifunction protection with control SIPROTEC 7SJ63	Function, operation, assembly and commissioning of the SIPROTEC device 7SJ63	C53000-G1140-C120-2
Input/output unit with local control SIPROTEC 6MD63	Function, operation, assembly and commissioning of the SIPROTEC device 6MD63	C53000-C1840-C101-2
Multifunctional machine protection SIPROTEC 7UM61	Function, operation, assembly and commissioning of the SIPROTEC device 7UM61	C53000-G1176-C127-1
PROFIBUS-DP Bus mapping 7SJ61/62/63, 6MD63	Data in den PROFIBUS-DP messages of the SIPROTEC device 7SJ61/62/63 and 6MD63	C53000-L1840-B006-02
PROFIBUS-DP Bus mapping 7UM61	Data in den PROFIBUS-DP messages of the SIPROTEC device 7UM61	C53000-L1840-B005-02

The PROFIBUS-DP specification and the structure of the PROFIBUS-DP messages are defined in the European standard EN 50170:

- PROFIBUS Specification
Normative Parts of PROFIBUS-FMS, -DP., -PA
According to the European Standard
EN 50170 Volume 2
Edition 1.0, May 1998
PROFIBUS Nutzerorganisation e.V.
Order-No. 0.032 or 0.042 on CD ROM

Notes to this manual

This manual provides you with the following aids to make it easier to locate the information you are looking for:

- At the beginning of this manual you will find a complete table of contents plus separate lists of figures and tables contained in this manual.
- In the individual chapters, you will find information in the left margin of each page which will give you an overview of the contents of that particular paragraph.
- Following the last chapter of this manual, you will find a glossary containing definitions of technical terms and abbreviations used in this manual.
- At the end of this manual, you will find a comprehensive index for fast access to the information you need.

Validity

This manual is valid for

- SIPROTEC devices 7SJ61, 7SJ62, 7SJ63 and 6MD63 with
 - firmware version 4.2 or higher and
 - PROFIBUS-DP communication module version 01.00.07 or higher,
- SIPROTEC devices 7UM61 with
 - firmware version 4.0 or higher and
 - PROFIBUS-DP communication module version 01.03.01 or higher.

For device parameterization **DIGSI version 4.2 or higher** and PROFIBUS-DP standard mappings 2-1 to 2-n (n = device type dependent number of standard mappings) have to be used.

Training courses

See our catalog of courses for a list of available courses or contact our Training center in Nuremberg.

Questions

If you have questions to the SIPROTEC devices, contact your Siemens representative.

Revision index

<i>Modified chapters / pages</i>	<i>Edition</i>	<i>Reasons of modification</i>
	1.0	First edition, Doc.-No.: C53000-L1840-B001-02 Sep 11 th , 2000

Table of contents

1	Bus specific parameters.....	1-1
2	Execution of switching operations via PROFIBUS-DP	2-1
2.1	Command output modes.....	2-1
2.2	Behaviour under special operating conditions.....	2-3
3	Response in the event of disturbed communication to the PROFIBUS-DP master	3-1
4	Annunciations to the PROFIBUS-DP master.....	4-1
5	Data type definitions.....	5-1
5.1	Single-point indication (SP, Input)	5-2
5.2	Single command (SC, Output)	5-2
5.3	Double-point indication (DP, Input) / Double command (DC, Output).....	5-3
5.4	Measured value (signed integer).....	5-3
5.5	Metered measurand (unsigned long)	5-4
6	PROFIBUS-DP – Parameterization in DIGSI	6-1
6.1	Mapping files	6-1
6.2	Customization of the allocations.....	6-3
6.3	Scaling of measured values	6-7
6.3.1	Measurement conversion	6-7
6.3.2	Number representation in dependence of the parameterization	6-8
6.3.3	Parameterization of scaling values in DIGSI	6-10
6.4	Printing of the allocations on system interface	6-11
6.4.1	Configuration – complete (sorted by line).....	6-11
6.4.2	Routing – short (column-oriented, only BE, BA, LED, syst. interface)	6-13
7	Hardware interface.....	7-1
7.1	Technical data of the connection via the PSE module.....	7-1
7.2	Technical data of the connection via the PSO module	7-2
8	Glossary.....	8-1
9	Index.....	9-1

List of figures

Figure 5-1	Data type single-point indication.....	5-2
Figure 5-2	Data type single command.....	5-2
Figure 5-3	Data type double-point indication / double command	5-3
Figure 5-4	Data type measured value (signed integer)	5-3
Figure 5-5	Data type metered measurand (unsigned long).....	5-4
Figure 6-1	DIGSI Configuration matrix with columns for system interface routing.....	6-3
Figure 6-2	Definition of the position of an information in the PROFIBUS-DP message.....	6-4
Figure 6-3	Scaling settings of a measured value.....	6-10
Figure 6-4	Print option "Configuration – complete (sorted by line)"	6-11
Figure 6-5	Annunciations in the printout "Configuration – complete (sorted by line)"	6-12
Figure 6-6	Measured values in the printout "Configuration – complete (sorted by line)"	6-12
Figure 6-7	Print option "Routing – short (column-oriented)"	6-13
Figure 6-8	Annunciations in the printout " Routing – short (column-oriented)"	6-14
Figure 6-9	Measured values in the printout " Routing – short (column-oriented)"	6-14

List of tables

Table 7-1	Technical data of the connection via the PSE module	7-1
Table 7-2	Assignment of the bus connection at the device (D-SUB outlet)	7-2
Table 7-3	Technical data of the connection via the PSO module	7-2

1

Bus specific parameters

The following settings for the serial communication between the PROFIBUS-DP master and the PROFIBUS-DP slave of the SIPROTEC device have to be defined when programming the device.

Slave address The PROFIBUS-DP slave address of the SIPROTEC device is set using the parameterization system DIGSI. Permissible slave addresses are in the range between 1 and 126.

Baud rate The PROFIBUS-DP slave of the SIPROTEC devices can communicate in a PROFIBUS-DP net with one of the following baud rates:
9.6; 19.2; 93.75; 187.5; 500, 1500; 3000 and 6000 kB/s.



Note

- At use of a SIPROTEC device with a **PSO** module the maximum baud rate is 1500 kB/s (ref. to chap. 7.2).
 - The PROFIBUS-DP slave of the SIPROTEC devices supports automatic baud rate recognition.
-

PNO identification number 80A1_{hex}

DDB file / GSD file „siem80A1.gsd“

Device name „SIPROTEC4 DP-Modul“

Slave family Other field controller - SIPROTEC

Configuration data The DDB file characterises the SIPROTEC communication module as a “slave with modular design“, i.e. depending on the selected mapping, the number of input and output data is modified without changing the DDB file.

The configuration data to the various devices are contained in the corresponding bus mapping documents (ref. to page i).

Execution of switching operations via PROFIBUS-DP

2

2.1 Command output modes

The following types of commands are available in the SIPROTEC device:

Double commands Execution of the double commands, output to the switching devices and checkback signal are processed through two outputs respectively two bits, which are defined by "01" = OFF and "10" = ON.

Single commands Execution of the single commands, output to the switching devices and checkback signal are processed by one output respectively one bit, which is defined by "0" = OFF and "1" = ON.



Note

In deviation to the above-written definition, **control of the single and double commands** in the SIPROTEC device via PROFIBUS-DP is processed identically via two bits of the PROFIBUS-DP output message.

A command output in the SIPROTEC device can be executed as *continuous output* or *pulse output*.

Commands with continuous output Commands in the operation mode *continuous output* are executed (controlled), if in the corresponding pair of bits a value changeover (a slope) is recognized via PROFIBUS-DP from "quiescent status" or OFF to ON and they remain active until a new value changeover occurs from "quiescent status" or ON to OFF via PROFIBUS-DP.



Note

For the definition of the values for "quiescent status", ON and OFF ref. to chap. 5.2 and 5.3.

Commands with pulse output

Output of a control pulse to switch a switching device incl. monitoring the programmed times is executed autonomously by the SIPROTEC device.

The switching operation (the *pulse output* via the allocated binary outputs of the SIPROTEC device) is executed, if in the PROFIBUS-DP output message the value of the corresponding pair of bits is changed

- from "quiescent status" or ON to OFF or from "quiescent status" or OFF to ON controlling double commands,
- from "quiescent status" to ON controlling single commands.

For controlling switching devices it is preferred to use *pulse outputs*, for which a number of parameters (e.g. output duration, overtravel time, checkback supervision time) have to be set using the parameterization software DIGSI.



Note

The switching direction OFF for single commands with *pulse output* is not permitted and is rejected in the SIPROTEC device.

2.2 Behaviour under special operating conditions



- A change of the switching device status which was not initiated by the PROFIBUS-DP master (e.g. circuit breaker trip) is recognized by the PROFIBUS-DP master by a change of the value of the switching device status in the corresponding bit positions of the input message. If the PROFIBUS-DP master wants to reclose the locally switched off switching device, then the current value (OFF) or “quiescent status” must first be transmitted via PROFIBUS-DP and then the switching device can be reclosed by setting the must-value to ON.
- A switching operation requested via PROFIBUS-DP which cannot be executed (e.g. because the control authority is set to LOCAL or the corresponding interlock conditions in the bay are not fulfilled), is recognized by the PROFIBUS-DP master from a discrepancy between the checkback signal of the double command or the status of the single command in the PROFIBUS-DP input message and the requested switching status (a checkback supervision time may be activated in the PROFIBUS-DP master). Before starting a new switching attempt, first the current switching status as per the input message or “quiescent status” has to be transmitted again in the output message via PROFIBUS-DP.
- The response in the event of disturbed communication is described in chap. 3.

Response in the event of disturbed communication to the PROFIBUS-DP master

3

The following response is defined for the SIPROTEC devices:

After detecting the interrupted connection to the PROFIBUS-DP master

1. The tagging **SYSINTERR** (Error Systeminterface) in the SIPROTEC device is set to ON (registration in the operations event log, processing in CFC is possible).
2. The status of the outputs and switching devices remains the same, as they were before the interruption of the communication.

After reestablishing the communication

1. The tagging **SYSINTERR** (Error Systeminterface) in the SIPROTEC device is set to OFF (registration in the operations event log, processing in CFC is possible).
2. The data from the messages which are now again received by the PROFIBUS-DP master are registered (*if this is possible according to the control authority status*).

If the switching device status of the SIPROTEC devices shall not be changed after reestablishing the communication between PROFIBUS-DP master and slave, then "quiescent status" (value "00") has to be transmitted in the output message's corresponding bit positions or the control authority has to be set to LOCAL.

Annunciations to the PROFIBUS-DP master

4



Note

When analysing the annunciations of the SIPROTEC device in the PROFIBUS-DP master, it should be noted that due to the cycle period of the PROFIBUS-DP system or due to the cyclic processing time of a PLC, temporary changes of an annunciation's value (ON and OFF within one cycle) may eventually not be recognized.

This applies in the first place for protection annunciations.

Protection pickup

Protection annunciations which indicate the status protection pickup, are active only for the period of time of the protection pickup.

Protection TRIP

The parameter **MINIMUM DURATION OF TRIP COMMAND** (parameter address = 210) allows setting of the minimum duration of the TRIP command.

This time setting applies to all protection functions which may cause a TRIP signal. After a protection TRIP, the corresponding protection annunciations transmit the value ON for the programmed minimum time duration.

Data type definitions

5

Following data types are used for storage of variables in PROFIBUS-DP messages:

- Single-point indications
- Single commands
- Double-point indications
- Double commands
- Measured values (signed integer)
- Metered measurands (unsigned long)



Note

The storage of variables of more complex data types (measured values, metered measurands) in the PROFIBUS-DP messages is processed according to the following convention:

The octet with the most significant byte (MSB) of the variable is transmitted prior to the octet with the least significant byte (LSB).

5.1 Single-point indication (SP, Input)

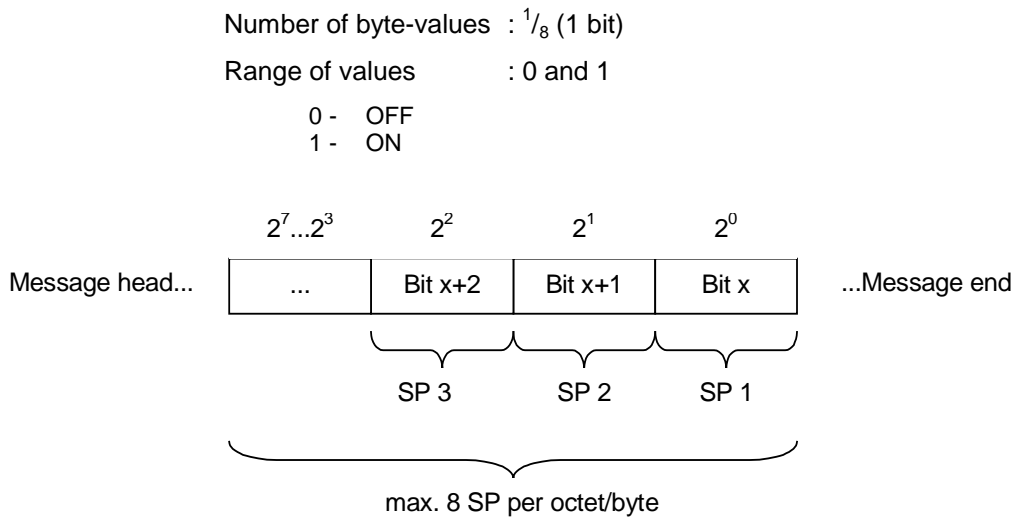

Figure 5-1 Data type single-point indication

5.2 Single command (SC, Output)

Single commands of the SIPROTEC device are controlled via PROFIBUS-DP by two bits (equivalent to double commands, ref. to chap. 2.1).

Number of byte-values : $\frac{1}{4}$ (2 bits)

Range of values : 0 to 3

- 0 (bit 1 = 0 and bit 0 = 0) - Quiescent status
- 1 (bit 1 = 0 and bit 0 = 1) - OFF
- 2 (bit 1 = 1 and bit 0 = 0) - ON
- 3 (bit 1 = 1 and bit 0 = 1) - not permissible

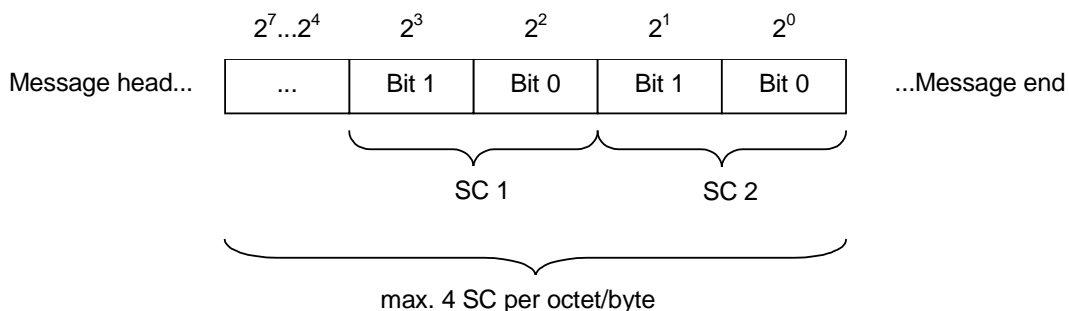

Figure 5-2 Data type single command

5.3 Double-point indication (DP, Input) / Double command (DC, Output)

Number of byte-values : $\frac{1}{4}$ (2 bits)

Range of values : 0 to 3

- 0 (bit 1 = 0 and bit 0 = 0) - „Not applicable“ for DP, Quiescent status for DC
- 1 (bit 1 = 0 and bit 0 = 1) - OFF
- 2 (bit 1 = 1 and bit 0 = 0) - ON
- 3 (bit 1 = 1 and bit 0 = 1) - Error status/Intermediate position for DP, not permissible for DC



Note

- „Not applicable“: double-point indication is not configured (not assigned to a binary input).
- The value „11“ ist transmitted for intermediate position „00“ too.

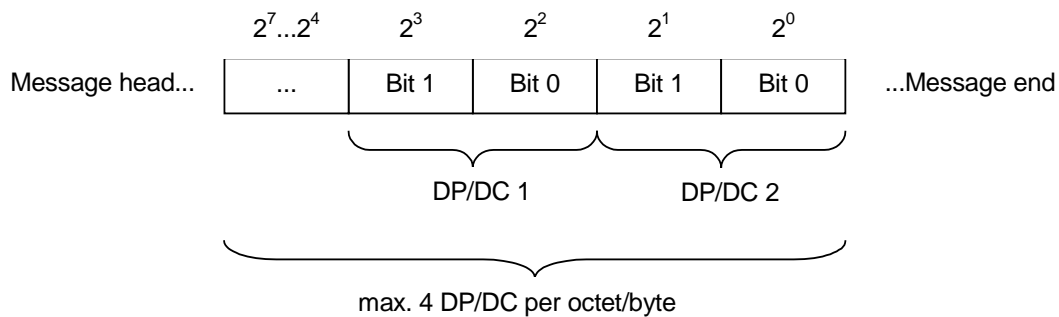

Figure 5-3 Data type double-point indication / double command

5.4 Measured value (signed integer)

Number of byte-values : 2

Range of values : -32768 to +32767
(-32768 = "Overflow" or "Invalid")

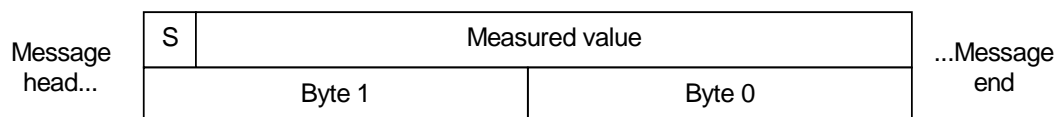

Figure 5-4 Data type measured value (signed integer)

Meaning of the status bits:

- S - Sign bit, active: negative measured value (two's complement)



Note

The value –32768 for signalling of „Overflow“ or „Invalid“ is only used for measured values in input direction. If an evaluation of the status of a measured value in output direction is required in the SIPROTEC device then a separate telegram position is to use to this (e.g. Application logic CFC).

5.5 Metered measurand (unsigned long)

Number of byte-values : 4

Range of values : 0 to +4294967295

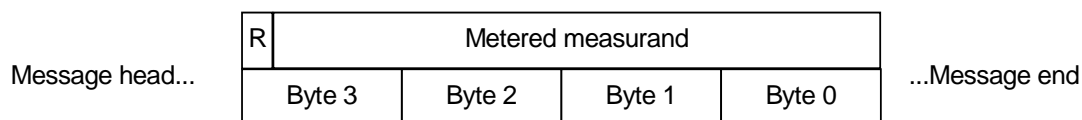

Figure 5-5 Data type metered measurand (unsigned long)

Meaning of the status bits:

R - reserved, not used at present

PROFIBUS-DP – Parameterization in DIGSI

6

6.1 Mapping files

The parameterization of PROFIBUS-DP for a SIPROTEC device requires the selection of a mapping file which fixes the allocation of the data objects of the SIPROTEC device to the positions in the PROFIBUS-DP messages. Bus specific parameters have to be defined simultaneously when selecting a mapping file (ref. to chap. 1).



Note

- The procedure to the selection of PROFIBUS-DP as the system interface for a SIPROTEC device and the setting of the mapping as well as the bus specific parameters are described in the chapter "Configuration – Serial interfaces" of the manual for operation, assembly and commissioning of the respective SIPROTEC device type (ref to page i).
 - The data in the PROFIBUS-DP messages, dependently on the selected mapping file, are defined in the bus mapping documentations (ref. to page i).
-

A number of standard mappings (standard mapping 2-1 to standard mapping 2-n, n = device type dependent number of standard mappings) are available for every SIPROTEC device type in DIGSI version 4.2 and higher.

These mappings are different in the data size available via PROFIBUS-DP and offer a standard allocation of selected data objects of the SIPROTEC device to positions in the PROFIBUS-DP message.

In adaptation to the concrete installation environment this standard allocation can be changed:

- remove of data objects from the PROFIBUS-DP message,
- routing of data objects to free message positions,
- scaling of measured values in accordance with the operating values of the primary equipment.



Note

The size of the PROFIBUS-DP messages (number of commands, annunciations, measured values, metered measurands) in output or input direction is exclusively fixed by the selection of a standard mapping.

The standard mappings 1 to standard mapping m (m = device type dependent number of standard mappings) enclosed to DIGSI 4.1 are offered for selection furthermore but shouldn't be used for new device parameterizations.

A customization of the allocation and scaling is not possible with these mappings.

6.2 Customization of the allocations

The identification whether an information is routed on system interface (PROFIBUS-DP) is shown in the columns "Source system interface" and "Destination system interface" in the DIGSI Configuration matrix.

A cross ('X') in this column indicates the associated information as "routed on system interface".

Source Information type system interface Destination system interface

	Information				Source							Destination			
	No.	Display text:	Long text:	Type	Bl	F	S	C	BO	LE	Buf	S	C	Displa	CM
Measur em.Superv												*			
Cntrl Authority							*					*			
Control Device		Breaker	Breaker	CF_D12		X						X	X	X	X
		Breaker	Breaker	DP								X	X	X	X
		Disc.Swit.	Disconnect Switch	CF_D2		X						X	X	X	X
		Disc.Swit.	Disconnect Switch	DP								X	X	X	X
		EarthSwit	Earth Switch	CF_D2		X						X	X	X	X
		EarthSwit	Earth Switch	DP								X	X	X	X
		52 Open	Interlocking: 52 Open	IntSP			X								
		52 Close	Interlocking: 52 Close	IntSP			X								
		Disc.Open	Interlocking: Disconnect switch Open	IntSP			X								
		Disc.Close	Interlocking: Disconnect switch Close	IntSP			X								
		E Sw Open	Interlocking: Earth switch Open	IntSP			X								
		E Sw Cl.	Interlocking: Earth switch Close	IntSP			X								
		Block Data	Block Data Transmission to SCADA	IntSP			X								
		Q2 Op/Cl	Q2 Open/Close	CF_D2		X							X		
		Q9 Op/Cl	Q9 Open/Close	CF_D2		X							X		
		Q9 Op/Cl	Q9 Open/Close	DP									X		
		Fan ON/OFF	Fan ON/OFF	CF_D2											
	Fan ON/OFF	Fan ON/OFF	DP												

Figure 6-1 DIGSI Configuration matrix with columns for system interface routing

Source system interface

The SIPROTEC object can be controlled via PROFIBUS-DP.

This is possible for the following information types:

- IntSP Internal single-point indication (tagging)
- IntDP Internal double-point indication (tagging)
- SC/DC Singel control/Double control without feedback from process
- SF/DF Singel control/Double control with feedback from process

Destination system interface

The value of the SIPROTEC object is transmitted to the PROFIBUS-DP master.

This is possible for the following information types:

- SP Single-point indication
- DP Double-point indication
- Out Output annunciation
- IntSP Internal single-point indication (tagging)
- IntDP Internal double-point indication (tagging)
- MV Measured values
- MVMV Power meter (metered value, source is a measured value)
- PMV Pulse (metered value, source is a pulsed binary input)

To add or remove an information to "Source system interface" or "Destination system interface" set/reset the cross ('X') in the associated column of the DIGSI configuration matrix (pop-up menu when pressing the right mouse button).

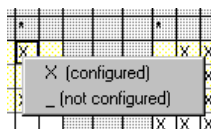

Note

The max. number of routable objects of an information type varies according to the chosen mapping file.



If e.g. a measured value not routed in the mapping file per default shall be transferred via PROFIBUS-DP, then first a measured value already routed has to be removed from system interface so that the position gets available in the PROFIBUS-DP message

An error message is shown if all routing possibilities of an information type are occupied and if it is nevertheless tried to route an information of this type.

Adding an allocation

Adding an allocation requires (in addition to the identification in the system interface column of the DIGSI Configuration matrix) the selection of the position of the information in the PROFIBUS-DP message as well as the definition of scaling values for measured values (scaling of measured values ref. to chap. 6.3).

Therefore after adding the allocation, the "Object properties" dialog window with which the message position of the information is defined using the property sheet "Protocol info source" or "Protocol info destination" is opened automatically.

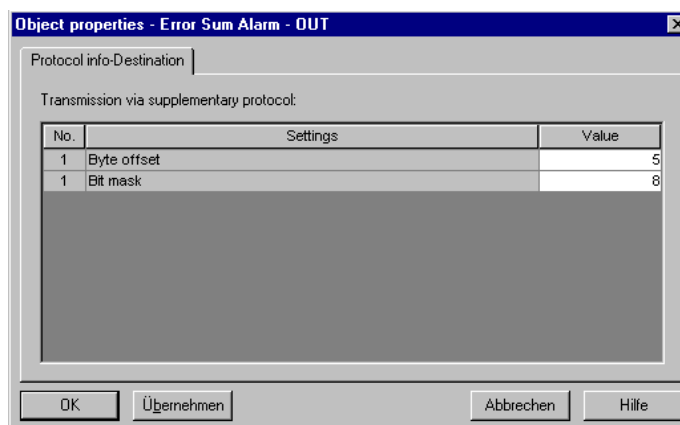
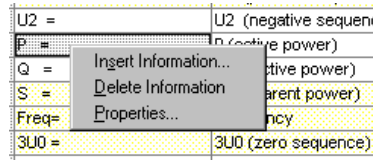

Figure 6-2 Definition of the position of an information in the PROFIBUS-DP message

Change of an existing allocation

If an information already routed on system interface shall get another (empty) position in the PROFIBUS-DP message, then the "Object properties" dialog window (ref. to Figure 6-2) has to be selected to this ("Properties ..." in the pop-up menu when pressing the right mouse button in the row associated to the information in one of the columns "Display text", "Long text" or "Type").



Dependent on the information type the following parameters are to select in the register "Protocol info source" or "Protocol info destination" of the "Object properties" dialog window:

Protocol info source

Parameter	Comments	Info types
Byte offset	The offset indicates the byte in the PROFIBUS-DP output message in which the bit value is placed.	IntSP, IntDP, SC/DC, SF/DF
Bit mask	The bit positions at which the information is defined are put on 1 in the byte value. The representation is an decimal number.	IntSP, IntDP, SC/DC, SF/DF

Protocol info destination

Parameter	Erläuterung	Infoarten
Byte offset	The offset indicates the byte in the PROFIBUS-DP input message in which the bit value is placed.	SP, DP, Out, IntSP, IntDP
	The offset indicates the beginning of the most significant byte in the message.	MV, MVMV, PMV
Bit mask	The bit positions at which the information is defined are put on 1 in the byte value. The representation is an decimal number.	SP, DP, Out, IntSP, IntDP

The first byte in the message has the byte offset = 0.

Example

The information "Error sum alarm" (ref. to Figure 6-2) is transferred after routing to "Destination system interface" (i.e. PROFIBUS-DP input message) at byte offset 5 (i.e. in the 6th byte), bit position 2³ (8_{dec} = 1000_{bin}).



Note

Only the positions in the PROFIBUS-DP message (byte offset, bit mask) are offered to the selection on which the information type still can be routed according to the mapping file and the current occupancy.

**Binary incoming
annunciations**

Binary incoming annunciations (marked with the sign '>' in the name, e.g. ">BLOCK 81-1") cannot be routed directly as "Source system interface". A control of these objects via PROFIBUS-DP as a substitute for using binary inputs is however often meaningful.

To do this, taggings (information type: IntSP) routed to "Source system interface" as well as "Destination CFC" are used. The binary incoming annunciation which is routed as "Source CFC" is connected via a CONNECT module in CFC to the tagging.

Example

Control of object ">BLOCK 81-1" using "CFC-Incoming annunciation 1 (UsCfcSpl1)" via PROFIBUS-DP:

- In the DIGSI configuration matrix set the source for ">BLOCK 81-1" to CFC output.
- All CFC-Incoming annunciations are released as CFC input by default, therefore no further actions in the DIGSI configuration matrix are necessary.
- Open a CFC working page and insert a CONNECT module.
- Connect the input ("BO X") of the CONNECT module with the operand "UsCfcSpl1" (group "Protocol").
- Connect the output ("Y BO") of the CONNECT module with the operand ">BLOCK 81-1" (group: "Frequency protection").
- Save and translate the CFC working page.

The object ">BLOCK 81-1" (and with that the associated protective function) can be influenced by changing the value of the "CFC-Incoming annunciation 1" via PROFIBUS-DP now.

6.3 Scaling of measured values

Measured values will be transferred via PROFIBUS-DP between the SIPROTEC device and the PROFIBUS-DP master as integer values (two bytes, ref. to chap. 5.4) but they are in general available in the SIPROTEC device in floating-point format as a percentage referred to the parameterized nominal values of the primary equipment.

6.3.1 Measurement conversion

Before transmission of a measured value via PROFIBUS-DP a measurement conversion (scaling) must be carried out in the SIPROTEC device.

Scaling Scaling of a measured value to the format for the transmission via PROFIBUS-DP means the definition of:

- *Type*,
- *Scaling factor*,
- *Zero offset*.

Type Decision, whether the measured value is transmitted as percentage value or whether a conversion shall take place into primary or secondary value before (depending on the measured value not all of these three possibilities are available, e.g. no secondary values for power values).

Scaling factor The measured value in the SIPROTEC device (floating-point format) is multiplied by the *Scaling factor* before transformation to an integer value (for PROFIBUS-DP message). It is possible to transfer fractional digits by multiplication by a multiple of 10 in the integer value with that.

Zero offset The *Zero offset* is added to the result of the multiplication of the measured value in the SIPROTEC device (floating-point format) by the scaling factor.

The measured value in the integer format for transmission via PROFIBUS-DP is calculated summarizing according to the following formula:

$$\text{Measured value}_{\text{Integer}} = \text{Measured value}_{\text{Float}} * \text{Scaling factor} + \text{Zero offset}$$

in which "Measured value_{Float}" is a percentage value or, if necessary, changed into primary value or secondary value before (according to the definition of *Type*).

6.3.2 Number representation in dependence of the parameterization

For specification of the scaling of a measured value it must be known in which number format (number of the relevant fractional digits) the measured value is available in the SIPROTEC device and to which unit it refers.

Percentage value

A scaling factor of 100 is recommended for percentage values.

With that the "Measured value_{Integer}" in the PROFIBUS-DP message has to be interpreted as:

$$\pm 32767 \text{ corresponds to } \pm 327.67 \%$$

Secondary value

The transmission of a measured value as secondary value is meaningful only in few cases (e.g. transducer measured values in mA).

The number of significant fractional digits depends on the installations and transducers data.

Primary value

The fractional digits and the respective unit at primary values depends tightly on the parameterized nominal values of the primary equipment (DIGSI: "Power system data 1" and "Power system data 2").

Voltages: $V_a, V_b, V_c, V_{a-b}, V_{b-c}, V_{a-c}, 3V_0, V1, V2$

Parameter: 1101 Nominal operation voltage of primary equipment

Parameter area	Number representation / unit
1.0 ... 10.0 kV	0.00 ... 99.99 kV
>10.0 ... 100.0 kV	0.0 ... 999.9 kV
>100.0 ... 1000.0 kV	0 ... 9999 kV
>1 MV	0 ... 99.99 MV

Displacement voltages: V_N

Parameter: 0202 Voltage transducer - Primary voltage
0206 Ratio factor V_{ph}/V_{delta}

Product of parameters 0202 and 0206	Number representation / unit
100.0 ... 1000.0 V	0 ... 9999 V
>1.0 ... 10.0 kV	0.00 ... 99.99 kV
>10.0 ... 100.0 kV	0.0 ... 999.9 kV
>100.0 ... 1000.0 kV	0 ... 9999 kV
>1 MV	0.00 ... 99.99 MV

Currents: $I_a, I_b, I_c, 3I_0, I_1, I_2$

Parameter: 1102 Nominal operating current of primary equipment

Parameter area	Number representation / unit
10 ... 100 A	0.0 ... 999.9 A
>100 ... 1000 A	0 ... 9999 A
>1 ... 10 kA	0.00 ... 99.99 kA

Ground currents: I_{Ns} , I_N

Parameter: 0204 Current transducer – Rated primary current
 0207 Ratio factor I_N / I_{ph} or (dependent on the device type)
 0208 Ratio factor I_{Ns} / I_{ph}

<i>Product of parameters 0204 and 0207 or 0204 and 0208</i>	<i>Number representation / unit</i>
0.0 ... 1.0 A	0 ... 9999 mA
>1.0 ... 10.0 A	0.00 ... 99.99 A
>10.0 ... 100.0 A	0.0 ... 999.9 A
>100.0 ... 1000.0 A	0 ... 9999 A
>1.0 kA ... 10.0 kA	0.00 ... 99.99 kA
>10 kA	0.0 ... 999.9 kA

Power: P, Q, S

Parameter: 1101 Nominal operation voltage of primary equipment
 1102 Nominal operating current of primary equipment

<i>Product of parameters 1101 and 1102 multiplied by $\sqrt{3}$</i>	<i>Number representation / unit</i>
10.0 ... 100.0 kW (kVAR)	0.0 ... 999.9 kW (kVAR)
>100.0 ... 1000.0 kW (kVAR)	0 ... 9999 kW (kVAR)
>1.0 ... 10.0 MW (MVAR)	0.00 ... 99.99 MW (MVAR)
>10.0 ... 100.0 MW (MVAR)	0.0 ... 999.9 MW (MVAR)
>100.0 ... 1000.0 MW (MVAR)	0 ... 9999 MW (MVAR)
>1.0 ... 10.0 GW (GVAR)	0.00 ... 99.99 GW (GVAR)
>10 GW (GVAR)	0.0 ... 999.9 GW (GVAR)

Example

Definition of the scaling for a power measurement value

In the parameter set is configured:

Nominal operation voltage of primary equipment (1101) = 12.00 kV

Nominal operating current of primary equipment (1102) = 100 A

It follows:

$$V_{nom} * I_{nom} * \sqrt{3} = 2078.46 \text{ kW (kVAR)} = 2.078 \text{ MW (MVAR)}$$

In the SIPROTEC device the power measurement values are available with the following number representation and unit (see table above):

0.00 ... 99.99 MW (MVAR)

According to this a scaling factor of 100 is meaningful.

With that the "Measured value_{Integer}" in the PROFIBUS-DP message has to be interpreted as:

+/- 32768 corresponds to +/- 327.68 MW (MVAR)

6.3.3 Parameterization of scaling values in DIGSI

The "Object properties" dialog window contains for measured values - besides the property sheet "Protocol info source" or "Protocol info destination" – an additional property sheet titled "Measured value destination".

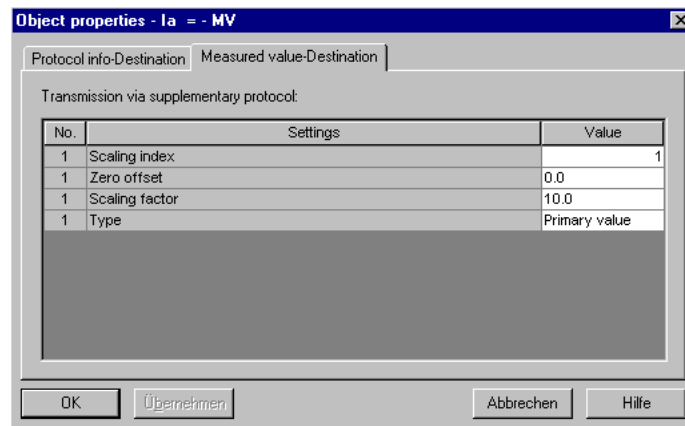

Figure 6-3 Scaling settings of a measured value

The scaling values assigned to the measured values per default are described in the bus mapping documents of the SIPROTEC device types (ref. to page i).

The change of the scaling and with that customization to the installation-specific operating values is made by selection of one scaling indices in the "Object properties" dialog window of the measured value.

Scaling index

A predefined scaling possibility (settings of *Type*, *Scaling factor* and *Zero offset*) is summarized using a scaling index.

Scaling index	Type	Scaling factor	Zero offset
0	Primary value	1.0	0.0
1	Primary value	10.0	0.0
2	Primary value	100.0	0.0
3	Primary value	1000.0	0.0
4	Primary value	10000.0	0.0
5	Secondary value	1000.0	0.0
6	Percentage value	100.0	0.0



If after change of the scaling a bus specific parameter is changed (e.g PROFIBUS-DP slave address, ref. to chap. 1), then all scalings are reset to their defaults according to the bus mapping documents (ref. to page i) again.

6.4 Printing of the allocations on system interface

The allocations on system interface incl. the scalings adjusted at measured values can be printed in two different views:

- Configuration – complete (sorted by line),
- Routing – short (column-oriented).

6.4.1 Configuration – complete (sorted by line)

Call Menu item "File – Print" and selection of "Configuration – complete (sorted by line)" in the "Print options" dialog window.

It is additional to select which information types (indications, commands etc.) the printout shall contain and which information filtration is used regarding the allocations.

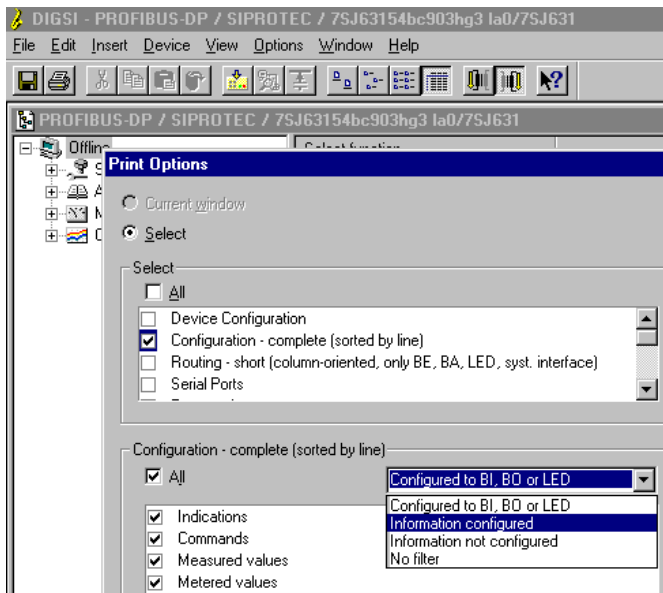

Figure 6-4 Print option "Configuration – complete (sorted by line)"

Contents The information – according to the selected information filtration (ref. to Figure 6-4) - are listed with the associated properties and allocations in the order of the lines of the DIGSI Configuration matrix.

Every chosen information type (indications, commands etc.) forms an own chapter in the printout.

Figure 6-5 and Figure 6-6 show examples of the printout of annunciations and measured values for a SIPROTEC device 7SJ63.

```

select in fault record
Chatter ON
Type: OUT - Output indication
Configured to destination:
Operation Buffer: ON/OFF
Properties
Error with a summary alarm
Type: OUT - Output indication
Configured to destination:
Operation Buffer: ON/OFF
System interface
Properties
Protocol info-Destination:
No. Settings Value
00001 Byte offset 5
00001 Bit mask 8
Alarm Summary Event
Type: OUT - Output indication
Configured to destination:
Operation Buffer: ON/OFF
System interface
Properties
Protocol info-Destination:
No. Settings Value
00001 Byte offset 5
00001 Bit mask 16
Error 5V
Type: OUT - Output indication
Configured to destination:
Operation Buffer: ON/OFF
Properties
Error 0V

```

Figure 6-5 Annunciations in the printout "Configuration – complete (sorted by line)"

```

Ia
Type: MV - Measured value
Configured to destination:
CFC
System interface
Properties
Protocol info-Destination:
No. Settings Value
00001 Byte offset 20
Measured value-Destination:
No. Settings Value
00001 Scaling index 1
00001 Zero offset 0.0
00001 Scaling factor 10.0
00001 Type Primary value
Ib
Type: MV - Measured value
Configured to destination:
CFC
System interface
Properties
Protocol info-Destination:
No. Settings Value
00001 Byte offset 22
Measured value-Destination:
No. Settings Value
00001 Scaling index 1
00001 Zero offset 0.0
00001 Scaling factor 10.0
00001 Type Primary value
Ic

```

Figure 6-6 Measured values in the printout "Configuration – complete (sorted by line)"

6.4.2 Routing – short (column-oriented, only BE, BA, LED, syst. interface)

Call Menu item "File – Print" and selection of "Routing – short (column-oriented, only BE, BA, LED, syst. interface)" in the "Print options" dialog window.

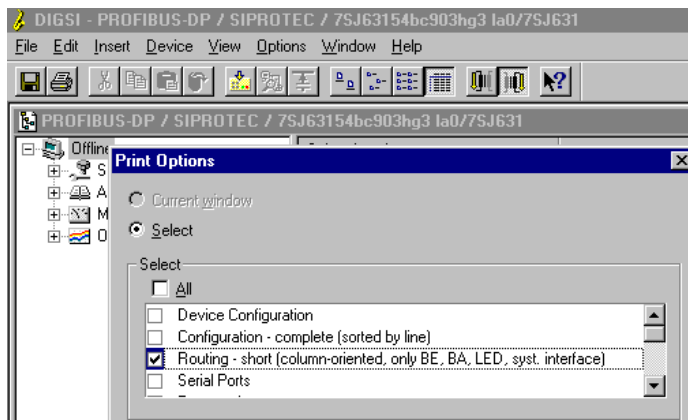

Figure 6-7 Print option "Routing – short (column-oriented)"

Contents The printout includes a table with listings of the information which are routed to:

- Binary outputs,
- Binary inputs,
- LED,
- System interface.

The columns in the chapter "System interface" are sorted by:

- Source/Destination system interface,
- Byte offset (ref. to chap. 6.2),
- Bit mask (the representation is a decimal number, interpretation as shown in example ref. to chap. 6.2, page 6-5).

Furthermore for measured values are printed out:

- Scaling index (ref. to chap. 6.3.3),
- Zero offset (ref. to chap. 6.3.1),
- Scaling factor (ref. to chap. 6.3.1),
- Type (ref. to chap. 6.3.1).

Figure 6-8 and Figure 6-9 show examples of the printout of information routed on system interface for a SIPROTEC device 7SJ63.

No.	Group	Information	Type	Status	Descriptor	Byt offset	Bit mask	Scaling index	Zeros offset	Scaling factor	Type
0070	Device, General	Setting calculation is running	OUT	X	5	4					
0140	Device, General	Error with a summary alarm	OUT	X	5	8					
0160	Device, General	Alarm Summary Event	OUT	X	5	16					
0501	P.System Data 2	Relay PICKUP	OUT	X	5	32					
0511	P.System Data 2	Relay GENERAL TRIP command	OUT	X	5	64					
1751	50/51 Overcur.	50/51 O/C switched OFF	OUT	X	7	1					
1756	50/51 Overcur.	50N/51N is OFF	OUT	X	7	2					
1761	50/51 Overcur.	50(N)/51(N) O/C PICKUP	OUT	X	7	4					
1762	50/51 Overcur.	50/51 Phase A picked up	OUT	X	7	8					
1763	50/51 Overcur.	50/51 Phase B picked up	OUT	X	7	16					
1764	50/51 Overcur.	50/51 Phase C picked up	OUT	X	7	32					
1765	50/51 Overcur.	50N/51N picked up	OUT	X	7	64					
1761	50/51 Overcur.	50(N)/51(N) TRIP	OUT	X	7	128					

Figure 6-8 Annunciations in the printout " Routing – short (column-oriented)"

No.	Group	Information	Type	Status	Descriptor	Byt offset	Bit mask	Scaling index	Zeros offset	Scaling factor	Type
0605	Measurement	I1 (positive sequence)	MV	X	50			1	0.0	10.0	Primary value
0606	Measurement	I2 (negative sequence)	MV	X	52			1	0.0	10.0	Primary value
0629	Measurement	V1 (positive sequence)	MV	X	54			3	0.0	100.0	Primary value
0630	Measurement	V2 (negative sequence)	MV	X	56			3	0.0	100.0	Primary value
0833	Demand meter	I1 (positive sequence) Demand	MV	X	66			1	0.0	10.0	Primary value
0834	Demand meter	Active Power Demand	MV	X	68			3	0.0	100.0	Primary value
1119	Fault Locator	Flt Locator: Distance to fault	OUT	X	70						
0888	Energy	Pulsed Energy Wp (active)	PMV	X	72						
0889	Energy	Pulsed Energy Wq (reactive)	PMV	X	76						
0924	Energy	Wp Forward	MVMV	X	80						
0925	Energy	Wq Forward	MVMV	X	84						
0926	Energy	Wp Reverse	MVMV	X	88						

Figure 6-9 Measured values in the printout " Routing – short (column-oriented)"

Hardware interface

Two communication modules are available for the connection of PROFIBUS-DP to the devices 7SJ61, 7SJ62, 7SJ63, 6MD63 and 7UM61:

- PROFIBUS module with isolated RS485 interface (**PSE module**),
- PROFIBUS module with fibre-optical interface (**PSO module**).

7.1 Technical data of the connection via the PSE module

Connections	9-pole D-SUB outlet (ref. to Table 7-2)	
Protocol	semi-duplex	
Max. line length (depending on the transmission rate)	9.6 kB/s 19.2 kB/s 93.75 kB/s 187.5 kB/s 500.0 kB/s 1500.0 kB/s 6000.0 kB/s	1000 m 1000 m 1000 m 500 m 200 m 200 m 100 m
Insulation level	500 V _{AC}	
Bus termination	Integrated, connectable terminating resistors 221 Ohm between RxD/TxD-P (B) and RxD/TxD-N (A) 392 Ohm between RxD/TxD-P (B) and VCC1 as well as RxD/TxD-N (A) and GND1 Input resistor not terminated ≥ 10 kOhm, then bus termination via bus plug with integrated terminating resistors.	
Level	Transmitter: Low: $-5\text{ V} \leq U_{A-B} \leq -1.5\text{ V}$ High: $+5\text{ V} \geq U_{A-B} \geq +1.5\text{ V}$ Receiver: Low: $U_{A-B} \leq -0.2\text{ V}$ High: $U_{A-B} \geq +0.2\text{ V}$ Transmitter and receiver are surge-proof for voltages between A and GND1 as well as between B and GND1 in the range of $-7\text{ V} \dots +12\text{ V}$.	
Cable	Bus cable type A according to EN 50170, twisted and screened. SIMATIC NET PROFIBUS 6XV1 830	
Plug	SIMATIC bus connection plug for PROFIBUS 6GK1 500-0EA02 with axial cable output, resistor combination integrated and connectable by sliding switch. Dimensions (B x H x T) : 39 mm x 15 mm x 57 mm Depth incl. cable bending radius : approx. 120 mm <u>Note:</u> When angle plugs or plugs with non-axial output are used, then the direction of the outgoing cable has to be coordinated with neighbouring terminals and plugs.	
Max. number of modules at the bus	32 ¹	

Table 7-1 Technical data of the connection via the PSE module

¹ For exclusive utilisation of PSE modules at the bus. This value could be smaller depending on the used PROFIBUS-DP master and further modules at the bus. If more than 32 devices at the bus are needed, RS485 repeaters (e.g. 6ES7 972-0AA00-0XA0) have to be used.

Pin	Signal	Meaning
1	Shield	Shield / operational ground
2	-	
3	RxD/TxD-P (B)	Reception data / transmission data - positive
4	RTS/CNTR-P	Directions control (TTL level)
5	GND1	Data transmission level (ground towards +5 V)
6	VCC1	Supply voltage of the terminating resistors (max. 100 mA)
7	-	
8	RxD/TxD-N (A)	Reception data / transmission data – negative
9	-	

Table 7-2 Assignment of the bus connection at the device (D-SUB outlet)

OLM

Recommended OLM for external PROFIBUS – fibre-optic transformation:

- SIMATIC NET OLM/S3 (6GK1 502-3AB10) with two RS485 channels and one fibre-optical channel,
- SIMATIC NET OLM/S4 (6GK1 502-4AB10) with two RS485 channels and two fibre-optical channels.

7.2 Technical data of the connection via the PSO module

Connections	fibre-optical interface, Rx and Tx, 820 nm, BFOC/2.5
Protocol	semi-duplex
Max. line length	<ul style="list-style-type: none"> • 2000 m / 1.25 miles for glass fibre 62.5/125 µm • approx. 2 m for plastic fibre
Max. number of modules in one optical ring (for 1500.00 kB/s)	41
Baud rate	max. 1500.00 kB/s
Optical budget	min. 8 dB for glass fibre 62.5/125 µm
Status for "no signal"	light OFF

Table 7-3 Technical data of the connection via the PSO module



Note

The PSO module is configured to communicate in a redundant optical ring (two fibre ring).
 At OLM/S3 or OLM/S4 put in this ring topology this corresponds at the OLM to the DIL switch positions S1 (mode) = 0, S2 (redundancy) = 1 and S5 (optical power) = 0.

Glossary

AR	Automatic Recloser
CFC	Continuous Function Chart
DC	Double Command
DDB file / GSD file	The DDB file contains the Device Data Base (technical characteristics) of the PROFIBUS-DP communication module (PROFIBUS-DP slave). This file is required for configuration and is supplied together with the SIPROTEC device.
DIGSI	Parameterization system for SIPROTEC devices
DP	Double-point Indication
Input data/ input direction	Data from the PROFIBUS-DP slave to the PROFIBUS-DP master .
Octet	Term from EN 50170, one octet corresponds to 8 bits.
OLM	Optical Link Module
Output data/ output direction	Data from the PROFIBUS-DP master to the PROFIBUS-DP slave .
PNO	PROFIBUS Nutzerorganisation
PROFIBUS-DP	PROFIBUS - Decentralized Peripherals
PSE	PROFIBUS interface module with (electrical) isolated RS485 interface for the SIPROTEC devices from Siemens.
PSO	PROFIBUS interface module with optical interface for the SIPROTEC devices from Siemens.
SC	Single Command
SP	Single-point Indication

Index

A

Additional literature i
allocation 6-4

B

baud rate 1-1
Binary incoming annunciations 6-6
bit mask 6-5
byte offset 6-5

C

checkback signal 2-3
circuit breaker trip 2-3
Commands with continuous output 2-1
command output 2-1
Commands with pulse output 2-2
Configuration data 1-2
control authority 2-3
control pulse 2-2
cycle period 4-1
cyclic processing time 4-1

D

data types 5-1
Device name 1-1
DISGI Configuration matrix 6-3
DDB file / GSD file 1-1
Device name 1-1
disturbed communication 2-3
double command 2-1, 5-3
double-point indication 5-3

I

interlock conditions 2-3
intermediate position 5-3

M

mapping file 6-1
Max. line length 7-1
Max. number of modules 7-1
measured value 5-3
metered measurand 5-4
minimum duration of the TRIP command 4-1

O

OLM 7-2

P

parameterization 6-1
percentage value 6-8
Plug 7-1
primary value 6-8
protection annunciations 4-1
Protection pickup 4-1
Protection TRIP 4-1
PSE module 7-1
PSO module 7-1

Q

quiescent status 2-2

S

Scaling factor 6-7
scaling index 6-10
secondary value 6-8
single command 2-1, 5-2
single-point indication 5-2
Slave address 1-1
standard mapping 6-1
system interface 6-3

T

Type 6-7

V

Validity ii

Z

Zero offset 6-7

