

# Technical Guidance Notes

## Ethernet Interface

### Ruggedcom RMC30

#### **DOCUMENTATION**

All referenced documents can be provided on request to Siemens Protection Devices Ltd. Tel No. +44 (0)191 401 5555. They can also be found on our website at [www.reyrolle-protection.com](http://www.reyrolle-protection.com).

The copyright and other intellectual property rights in this document, and in any model or article produced from it (and including any registered or unregistered design rights) are the property of Siemens Protection Devices Limited. No part of this document shall be reproduced or modified or stored in another form, in any data retrieval system, without the permission of Siemens Protection Devices Limited, nor shall any model or article be reproduced from this document unless Siemens Protection Devices Limited consent.

While the information and guidance given in this document is believed to be correct, no liability shall be accepted for any loss or damage caused by any error or omission, whether such error or omission is the result of negligence or any other cause. Any and all such liability is disclaimed.

## DOCUMENT RELEASE HISTORY

This document is issue **2007/12**. The list of revisions up to and including this issue is:

2007/12	First issue for Review
---------	------------------------

## CONTENTS

<b>Documentation .....</b>	<b>1</b>
<b>Document Release History.....</b>	<b>2</b>
<b>Contents .....</b>	<b>3</b>
<b>Section 1: Introduction .....</b>	<b>5</b>
<b>Section 2: Physical Connection.....</b>	<b>6</b>
2.1 Relay Communication ports.....	6
2.1.1 RS485 Interface .....	6
2.2 RMC30 .....	6
2.2.1 RS485 Interface .....	6
2.2.2 RS232 Interface .....	7
2.2.3 Ethernet Interface.....	7
2.2.4 Power Supply .....	8
<b>Section 3: Configuration of RMC30 Device .....</b>	<b>9</b>
3.1 Configure RMC30 IP Address.....	9
3.2 Configure RMC30 MODBUS Parameters.....	13
3.3 Configure RMC30 DNP3 Parameters .....	22
3.4 Configure RMC30 Tunnel Parameters .....	26
<b>Section 4: Definitions.....</b>	<b>27</b>
4.1 Introduction .....	27
<b>Section 5: Glossary .....</b>	<b>28</b>
<b>Section 6: Appendix.....</b>	<b>29</b>

## List of Figures

Figure 1 – Relay of COM1 Port Settings .....	6
Figure 2 – RMC30 Phoenix Serial Connector, RS485 2 wire connection .....	7
Figure 3 – RMC30 RS232 connection .....	7
Figure 4 – RMC30 Bottom View Showing Power Supply Connection .....	8
Figure 5 – RMC30 Confirm Screen .....	9
Figure 6 – RMC30 Boot Screen .....	10
Figure 7 – RMC30 Login Screen .....	10
Figure 8 – RMC30 Example Login Screen .....	10
Figure 9 – RMC30 Main Menu .....	11
Figure 10 – RMC30 Administration Menu .....	11
Figure 11 – RMC30 IP Interfaces Menu .....	12
Figure 12 – RMC30 IP Apply Address Changed .....	12
Figure 13 – RMC30 IP Address Changed .....	13
Figure 14 – RMC30 Admin Logout Screen .....	13
Figure 15 – RMC30 Browser Interface – Initial Page .....	14
Figure 16 – RMC30 Browser Interface – Main Menu .....	15
Figure 17 – RMC30 Browser Interface – Serial Protocols Menu .....	16
Figure 18 – RMC30 Browser Interface – Serial Ports Configuration Page .....	17
Figure 19 – RMC30 Browser Interface – Serial Port 1 Configuration Page .....	18
Figure 20 – RMC30 Browser Interface – Empty Device Address Table Page .....	19
Figure 21 – RMC30 Browser Interface – Device Address Editor Page .....	20
Figure 22 – RMC30 Browser Interface – Populated Device Address Table Page .....	21
Figure 23 – RMC30 RMC30 Browser Interface – Logged Out Page .....	22
Figure 24 – RMC30 Browser Interface – Serial Port for DNP3 .....	23
Figure 25 – RMC30 Browser Interface – PC DNP3 Device Entry .....	24
Figure 26 – RMC30 Browser Interface – IED DNP3 Device Entry .....	25
Figure 27 – RMC30 Browser Interface – IED DNP3 Device Entry .....	26
Figure 28 – RMC30 Browser Interface – Serial Port for Raw Socket .....	26
Figure 29 – Rear Terminals for E8 case (5CT/4VT) .....	29

## Section 1: Introduction

This note describes the connection of the RUGGEDCOM RMC30 external Ethernet interface to the RS485 port of Reyrolle Relays.

The new generation of Reyrolle relays support the DNP3 communications standard, in addition to MODBUS and IEC60870-5-103 provided previously. Each communications port allows the user to select a protocol, independent of the other ports, via a setting accessed through the Relay's fascia. In a communications system the Relay will be the slave device. There is a requirement for Ethernet access to these relays and the RMC30 device provides a solution to accomplish this requirement.

The RMC30 can be configured as a dedicated MODBUS server, DNP3 SERVER, or a simple Ethernet tunnel. Examples of all three methods are described below.

The information for the RMC30 was taken from [1] Rugged Operating System v3.2 User Guide, please refer to that document for a more detailed description of configuration.

## Section 2: Physical Connection

### 2.1 RELAY COMMUNICATION PORTS

#### 2.1.1 RS485 Interface

The RS485 communication port (COM1) is located on the rear of the relay and can be connected using a suitable RS485 120 ohm screened twisted pair cable. On the RM platform it uses terminals 14(A), 16(SCREEN), 18(B) and 20(TERM) of the PSU terminal block.

The RS485 electrical connection can be used in a single or multi-drop configuration. The RS485 master must support and use the Auto Device Enable (ADE) feature. The last device in the connection must be terminated correctly in accordance with the master device driving the connection. The relays are fitted with an internal terminating resistor which can be connected between A and B by fitting an external wire loop between terminals B and TERM on the power supply module. A full diagram of the rear terminal blocks is shown in the Appendix, Figure 29 – Rear Terminals for E8 case (5CT/4VT).

The maximum number of relays that can be connected to the bus is 64.

Access to the communication settings is only available from the relay front fascia via the **COMMUNICATIONS MENU**. The following settings must be configured via the relay fascia when using the RS485 interface.

Setting name	Range	Default	Setting	Notes
<b>Station Address</b>	0 ... 254	0	1-254	An address between 1 and 254 must be given to identify the relay. Each relay must have a unique address.
<b>COM1-RS485 Protocol</b>	OFF, IEC60870-5-103, MODBUS-RTU, DNP3	IEC60870-5-103	As Required	Sets the protocol used to communicate on the RS485 connection.
<b>COM1-RS485 Baud Rate</b>	75 110 150 300 600 1200 2400 4800 9600 19200 38400	19200	As Required	The baud rate set on all of the relays connected to the same RS485 bus must be the same as the one set on the master device.
<b>COM1-RS485 Parity</b>	NONE, ODD, EVEN	EVEN	As Required	The parity set on all of the relays connected to the same RS485 bus must be the same and in accordance with the master device.

Figure 1 – Relay of COM1 Port Settings

### 2.2 RMC30

#### 2.2.1 RS485 Interface

Connect the Serial Port terminals to the Relay. For an RS485 2 wire connection connect the –Rx terminal of the Phoenix connector to A on the Relay, and the +Rx terminal to B.

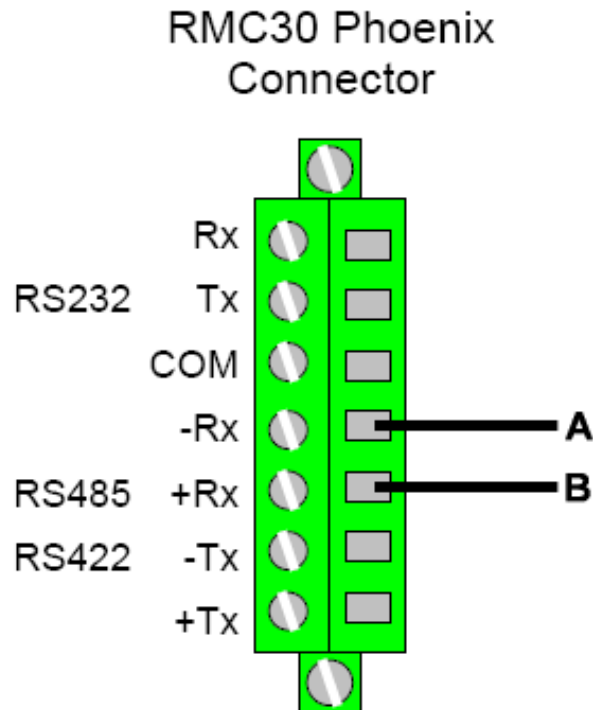

Figure 2 – RMC30 Phoenix Serial Connector, RS485 2 wire connection

### 2.2.2 RS232 Interface

If required you can connect the RS232 port of the RMC30 to a PC, for example, if you cannot configure the device via the Ethernet connection, as shown below.

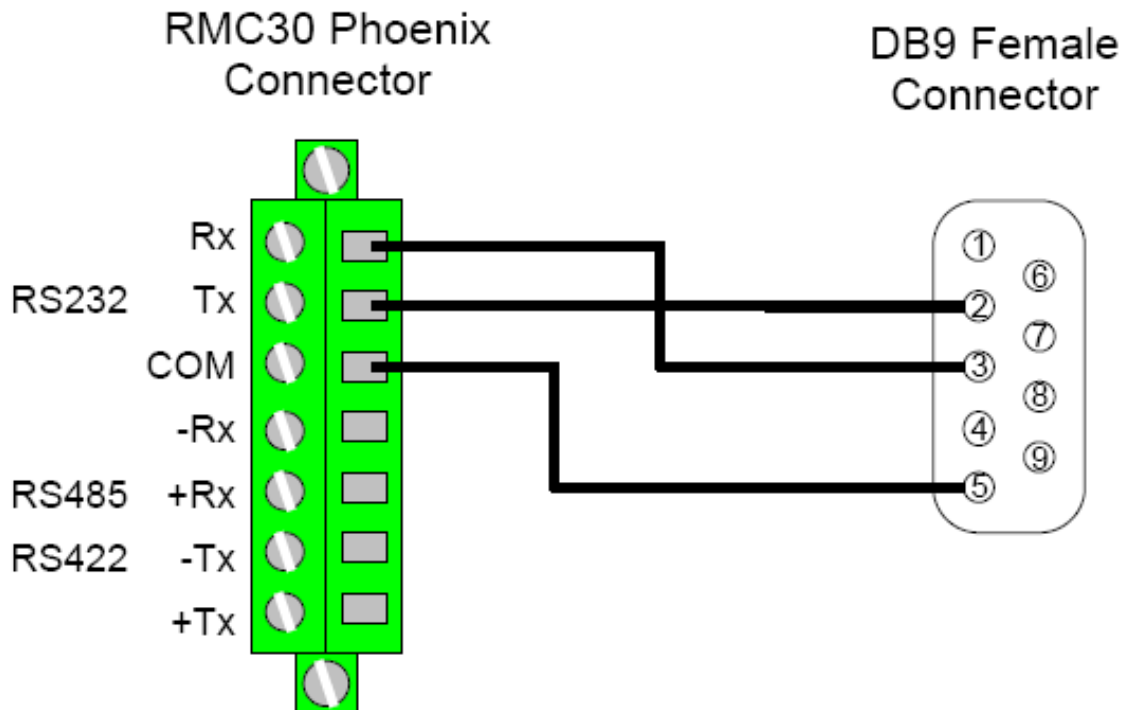

Figure 3 – RMC30 RS232 connection

### 2.2.3 Ethernet Interface

Connect the RMS30 to the network using a standard RJ45 Ethernet cable.

## 2.2.4 Power Supply

Connect a suitable PSU to the RMC30.

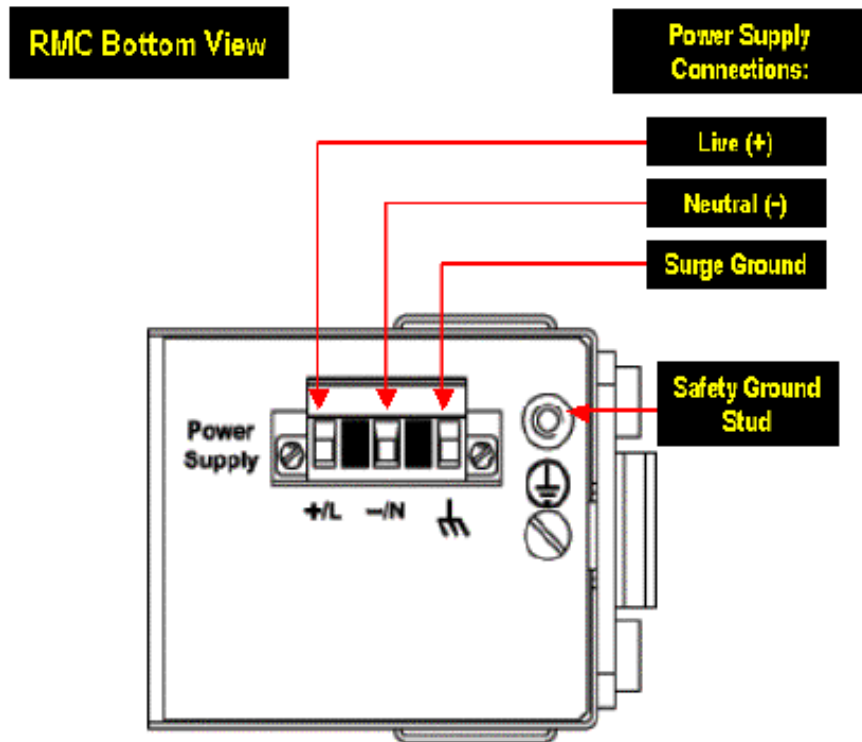

Figure 4 – RMC30 Bottom View Showing Power Supply Connection



## Section 3: Configuration of RMC30 Device

### 3.1 CONFIGURE RMC30 IP ADDRESS

You can change all the parameters via a Web Browser; however, to do this you must use the IP address of the RMC30 device. If the default address (192.168.0.1) is not suitable for your network you must change it using a Terminal program, e.g. HyperTerminal or TeraTerm. To do this you should connect the RS232 port of the RMC30 to a PC.

Power down the RMC30 and then temporarily disconnect the Ethernet cable and RS485 connection.

Start a terminal program connected to the PC serial port with parameters Baud Rate 57600, No Parity, 8 bit data and VT100 emulation. While holding down CTRL+Z on the PC keyboard power up the RMC30. After a short while you will be presented with a screen as follows.

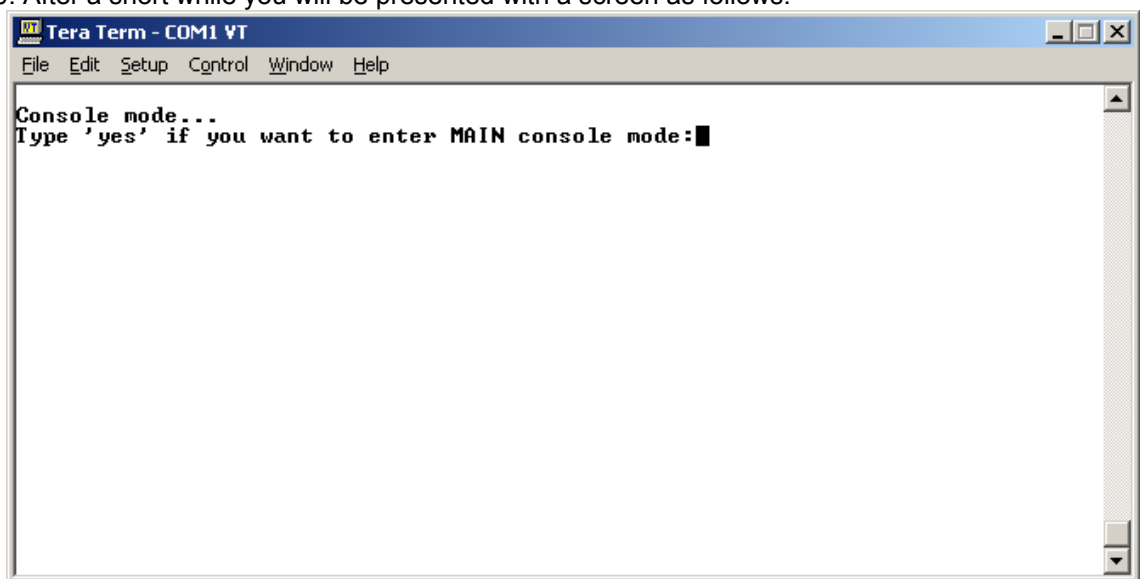

Figure 5 – RMC30 Confirm Screen

Type **yes** to continue

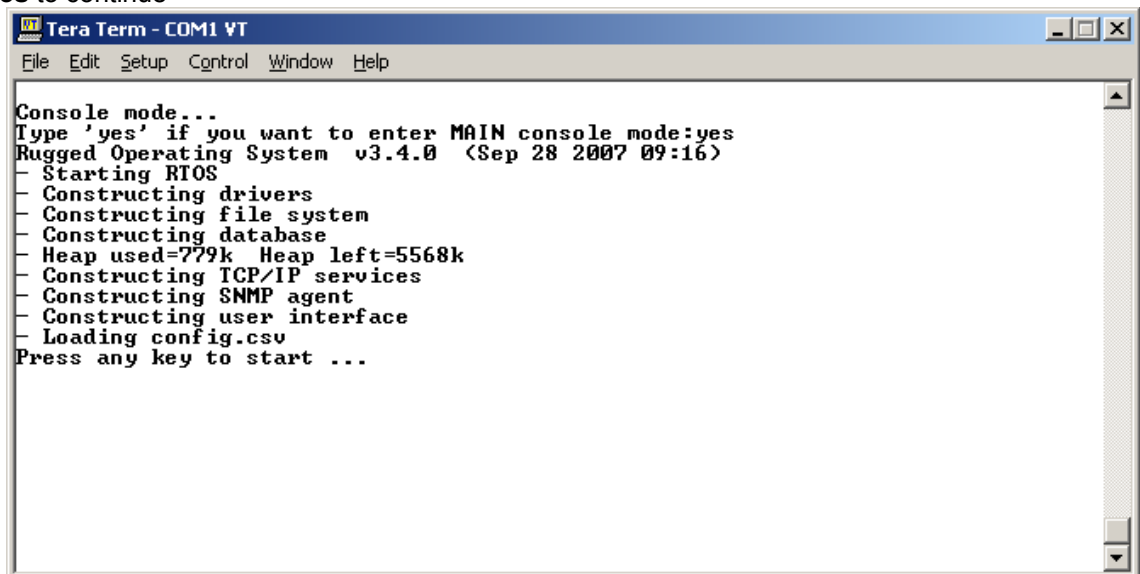

Figure 6 – RMC30 Boot Screen

Press a key to continue

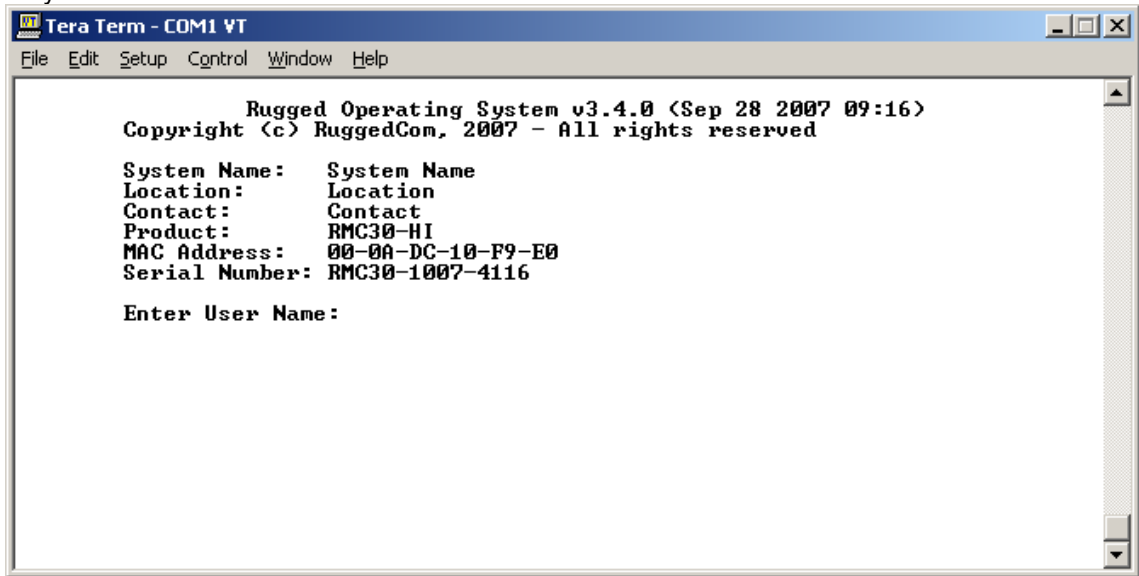

Figure 7 – RMC30 Login Screen

Enter **admin** for both the user name and password, press return after each.

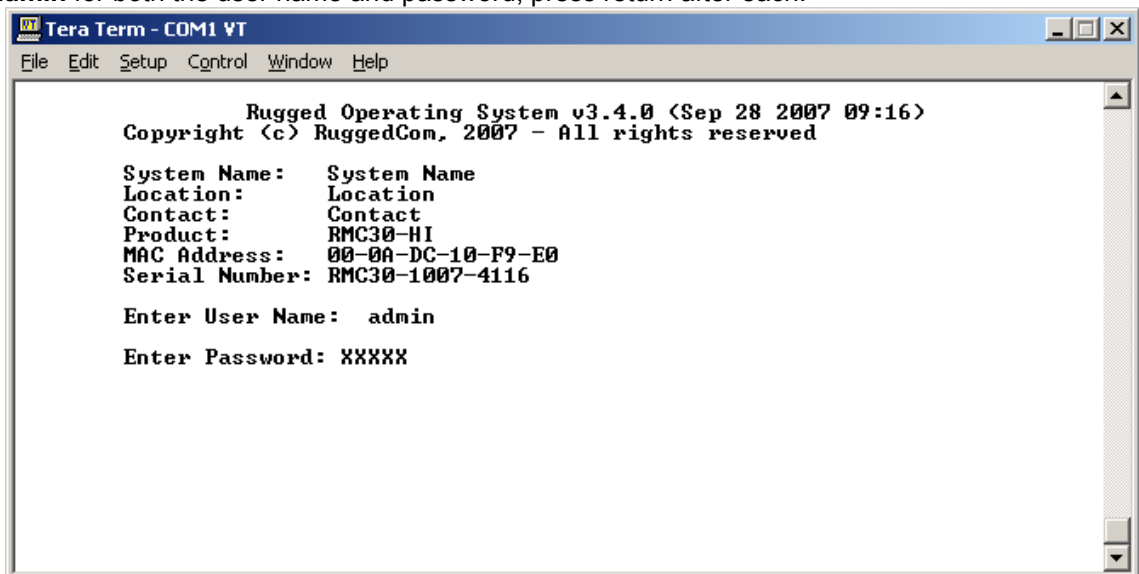

Figure 8 – RMC30 Example Login Screen

The main menu screen is displayed. Use the arrow keys (←↑↓→) to navigate menus, Enter to enter a menu and Escape to leave it and return to the previous level.

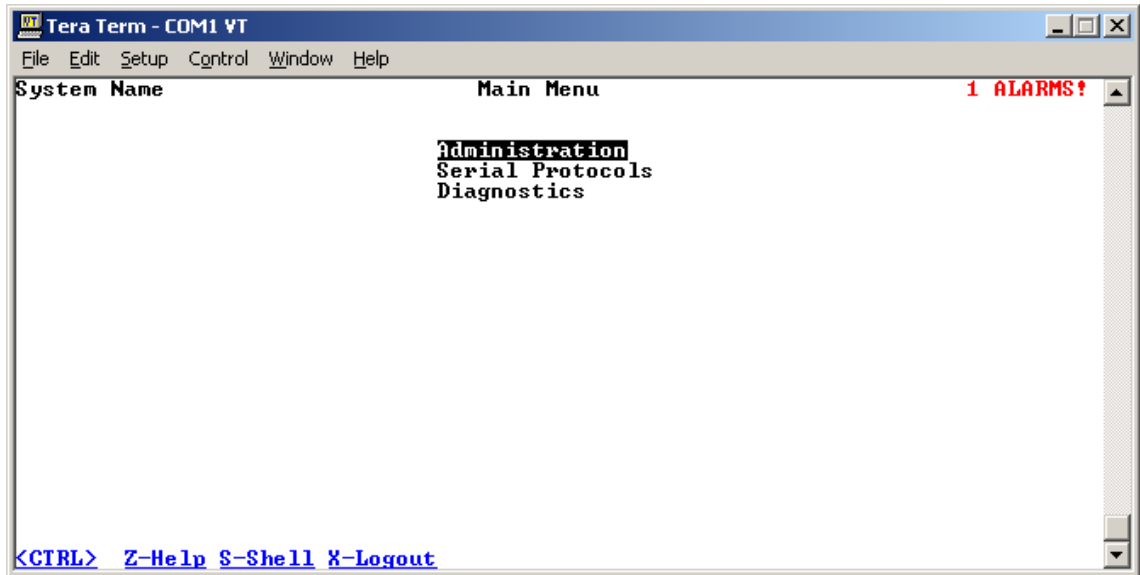

Figure 9 – RMC30 Main Menu

Press return to open the **Administration** menu.

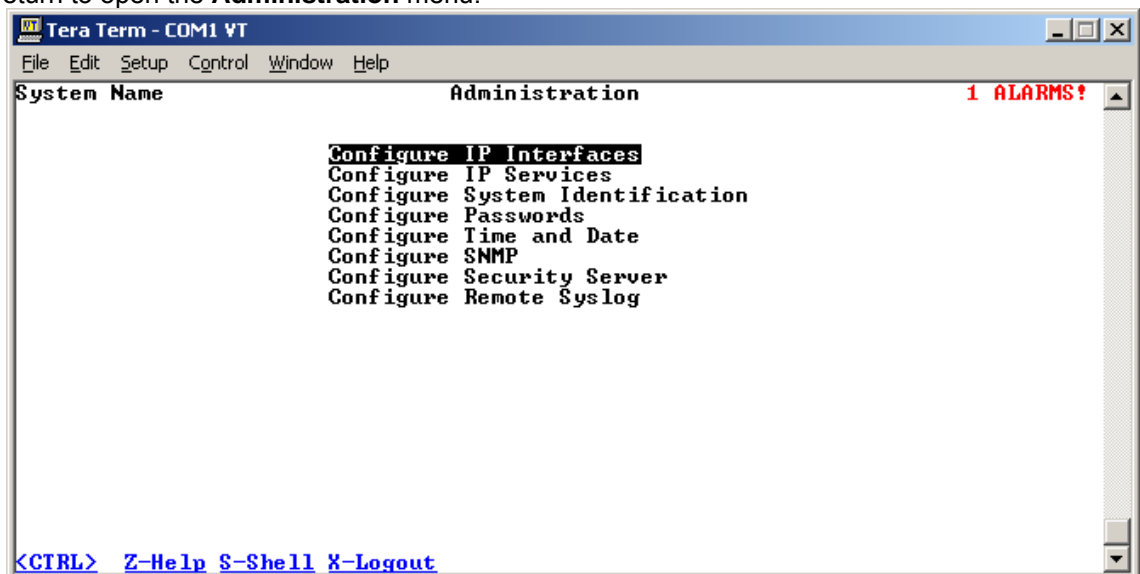

Figure 10 – RMC30 Administration Menu

Press return to open the **Configure IP Interfaces** menu.

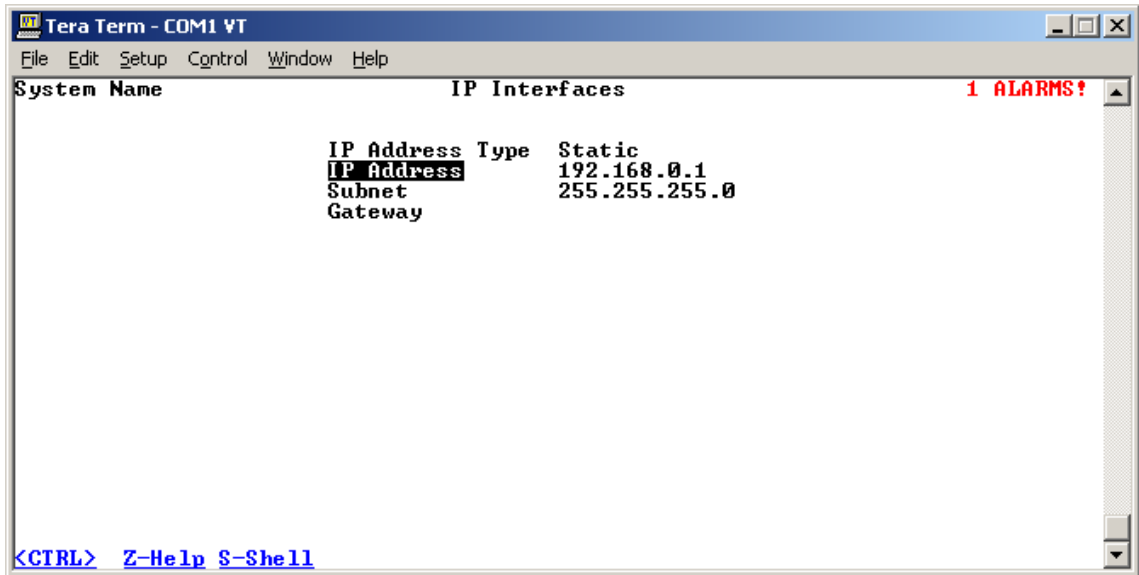

Figure 11 – RMC30 IP Interfaces Menu

Select the IP Address setting and press Enter to edit it. Type a suitable IP address for the network.

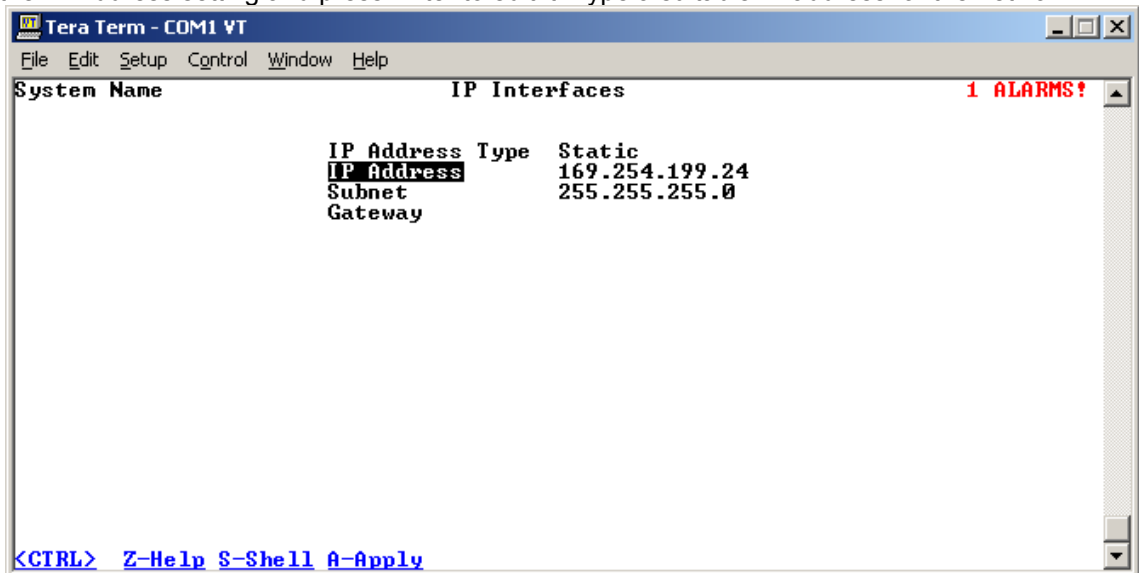

Figure 12 – RMC30 IP Apply Address Changed

For the purposes of this test the IP address used is 169.254.199.24. Press the return key to accept the new address, and then CTRL+A to apply it.

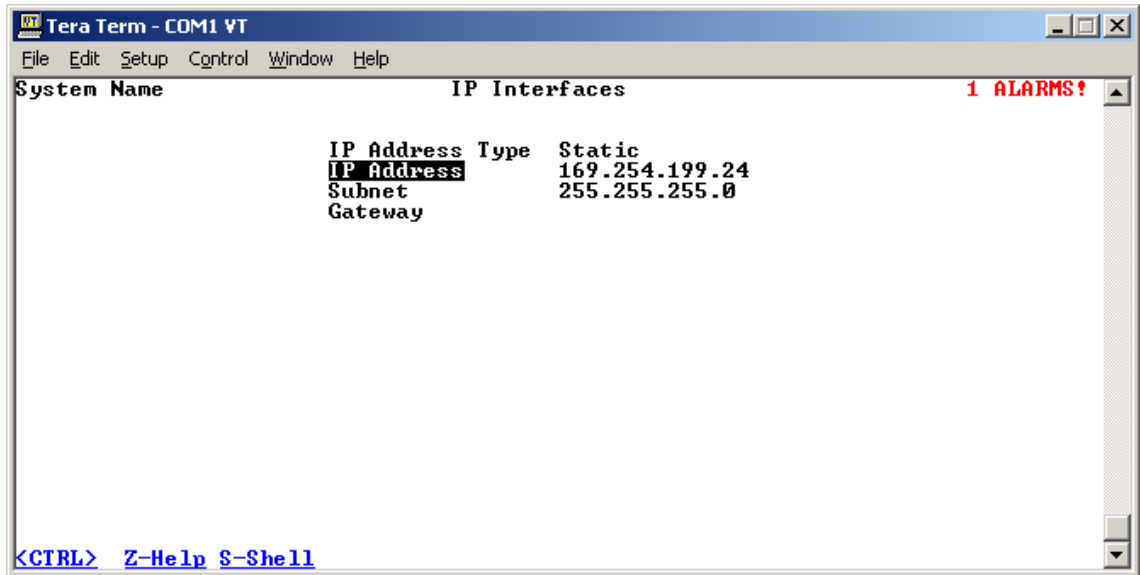

Figure 13 – RMC30 IP Address Changed

Press CTRL+X to exit the logout.

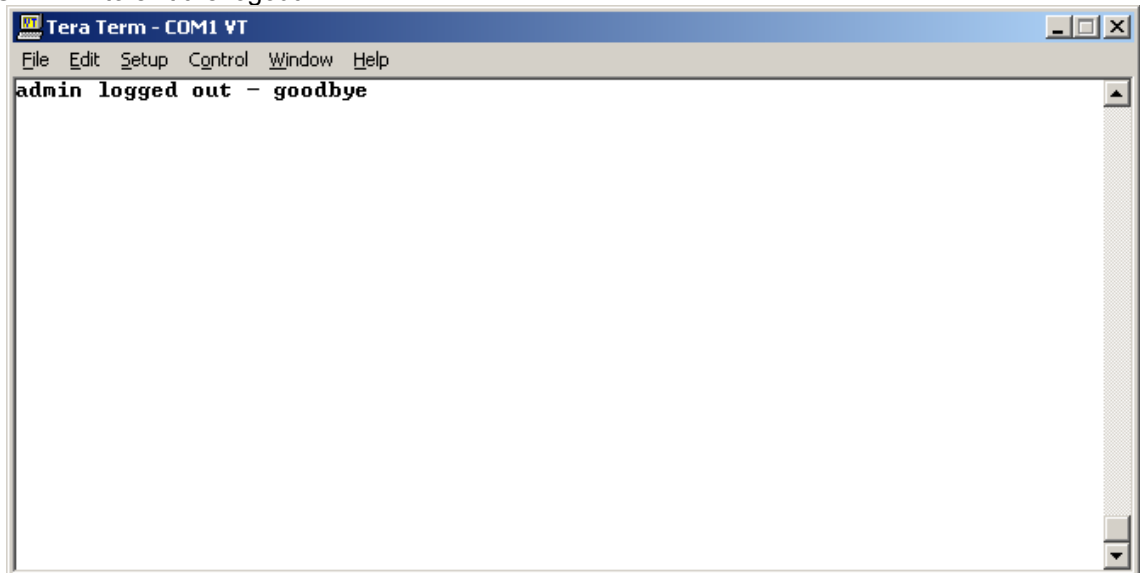

Figure 14 – RMC30 Admin Logout Screen

Reboot the RMC30

### 3.2 CONFIGURE RMC30 MODBUS PARAMETERS

To configure parameters, start up a web browser and attach to the IP address set in section 3.1, in this example 169.254.199.24. You will be presented with the initial page as shown below.

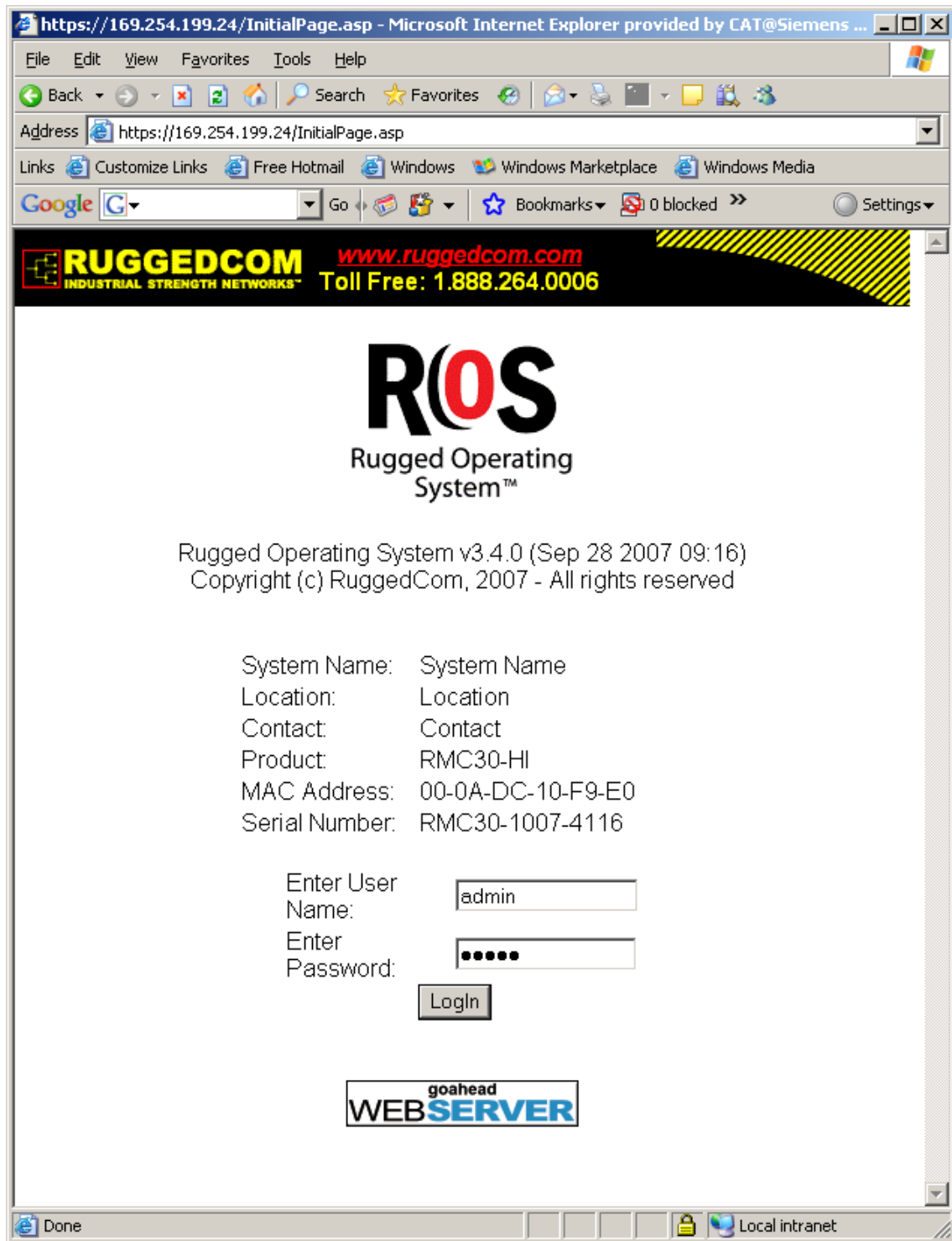

Figure 15 – RMC30 Browser Interface – Initial Page

First, login to the device, again using “admin” as both the User Name and Password. After logging in you will be presented with the main menu page.

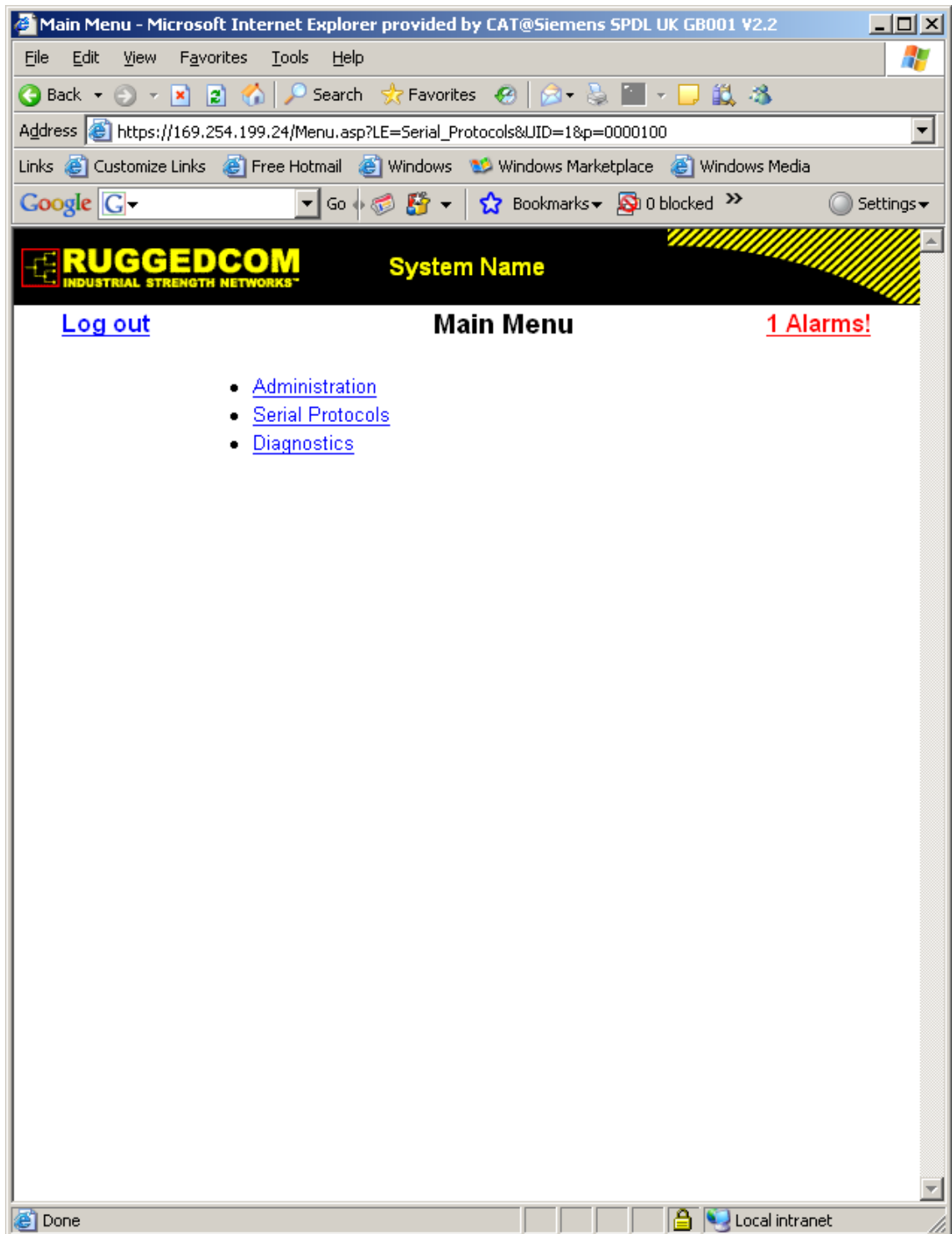

Figure 16 – RMC30 Browser Interface – Main Menu

Click on **Serial Protocols** to open the tree.

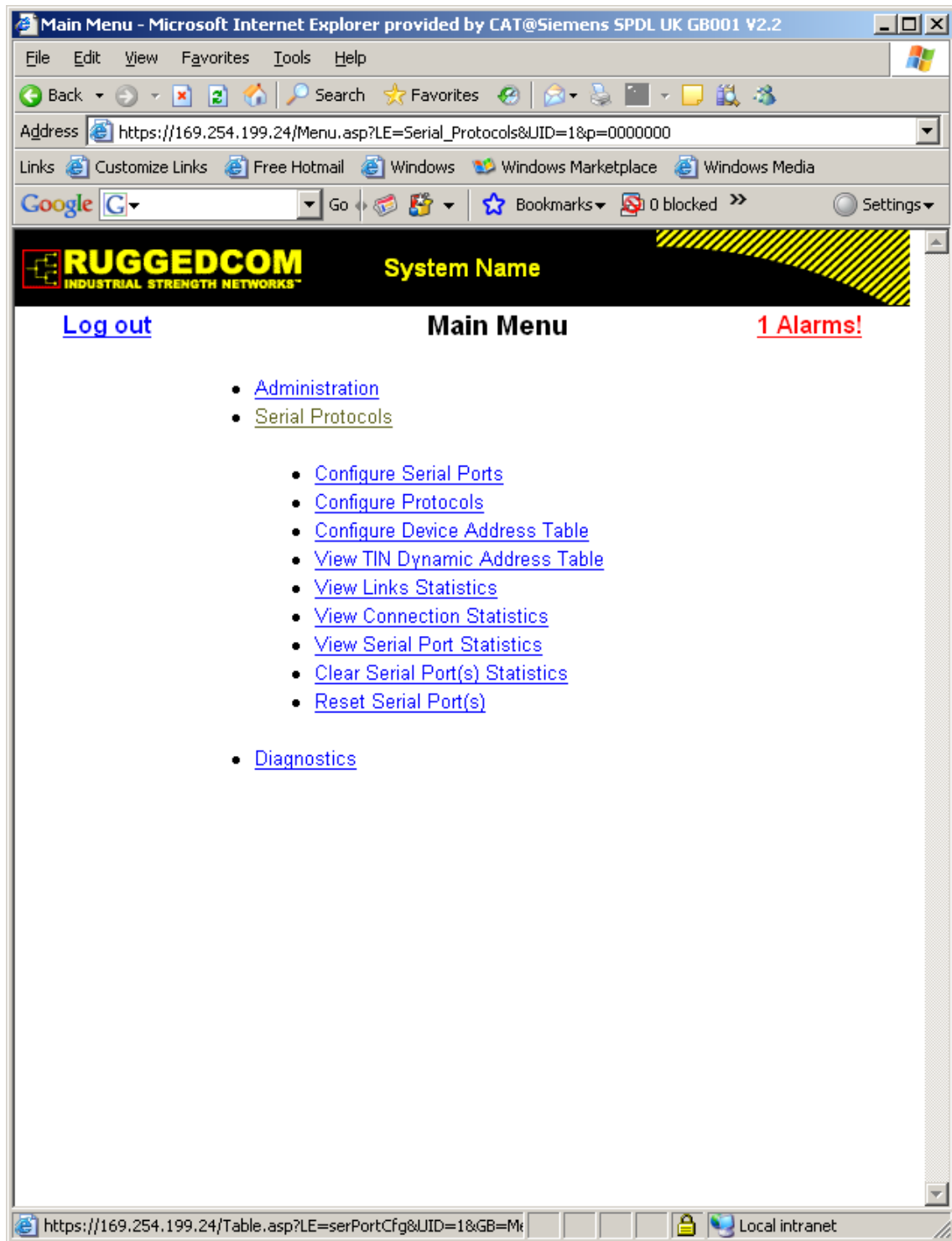

Figure 17 – RMC30 Browser Interface – Serial Protocols Menu

Click on **Configure Serial Ports** to open the page.



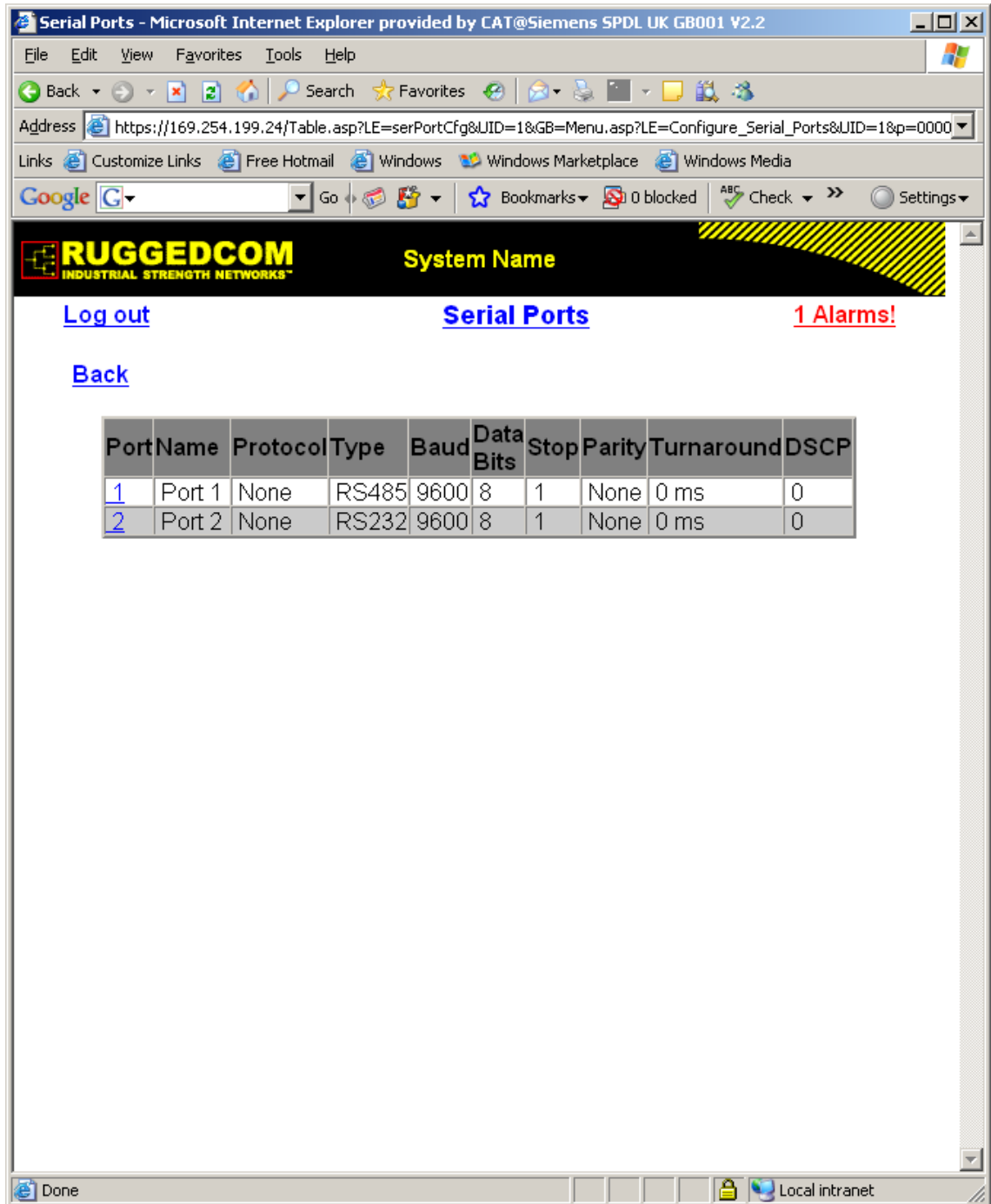

Figure 18 – RMC30 Browser Interface – Serial Ports Configuration Page

Click on 1 to configure port 1.

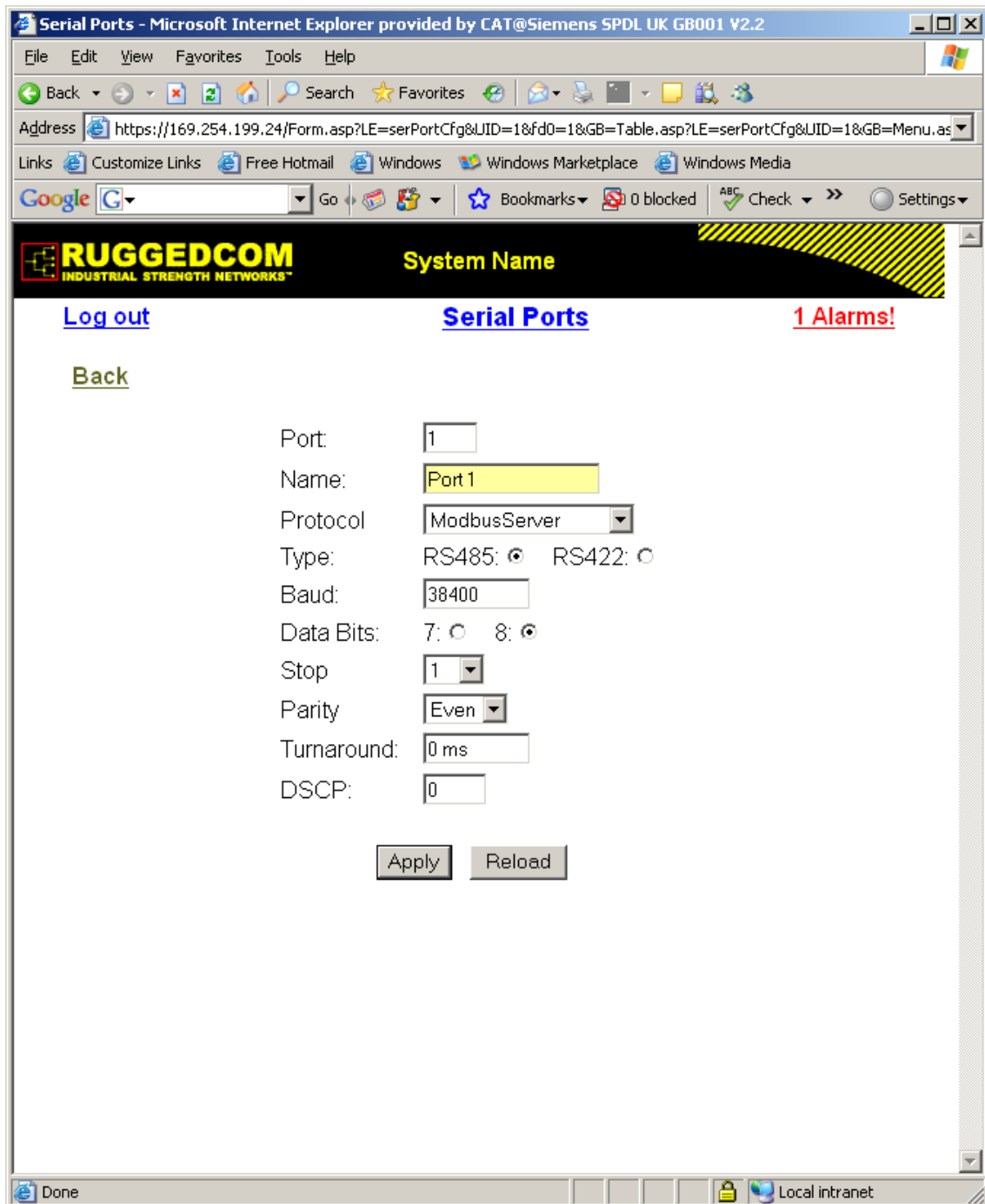

Figure 19 – RMC30 Browser Interface – Serial Port 1 Configuration Page

Set the protocol to MODBUS Server, type to RS485, and Baud Rate, Parity etc. to appropriate values. Click **Apply** to save the changes, note the confirmation message. Click **Back** to return to the Main Menu.

From the Main Menu Serial Protocols tree click **Configure Device Address Table** to open the page.

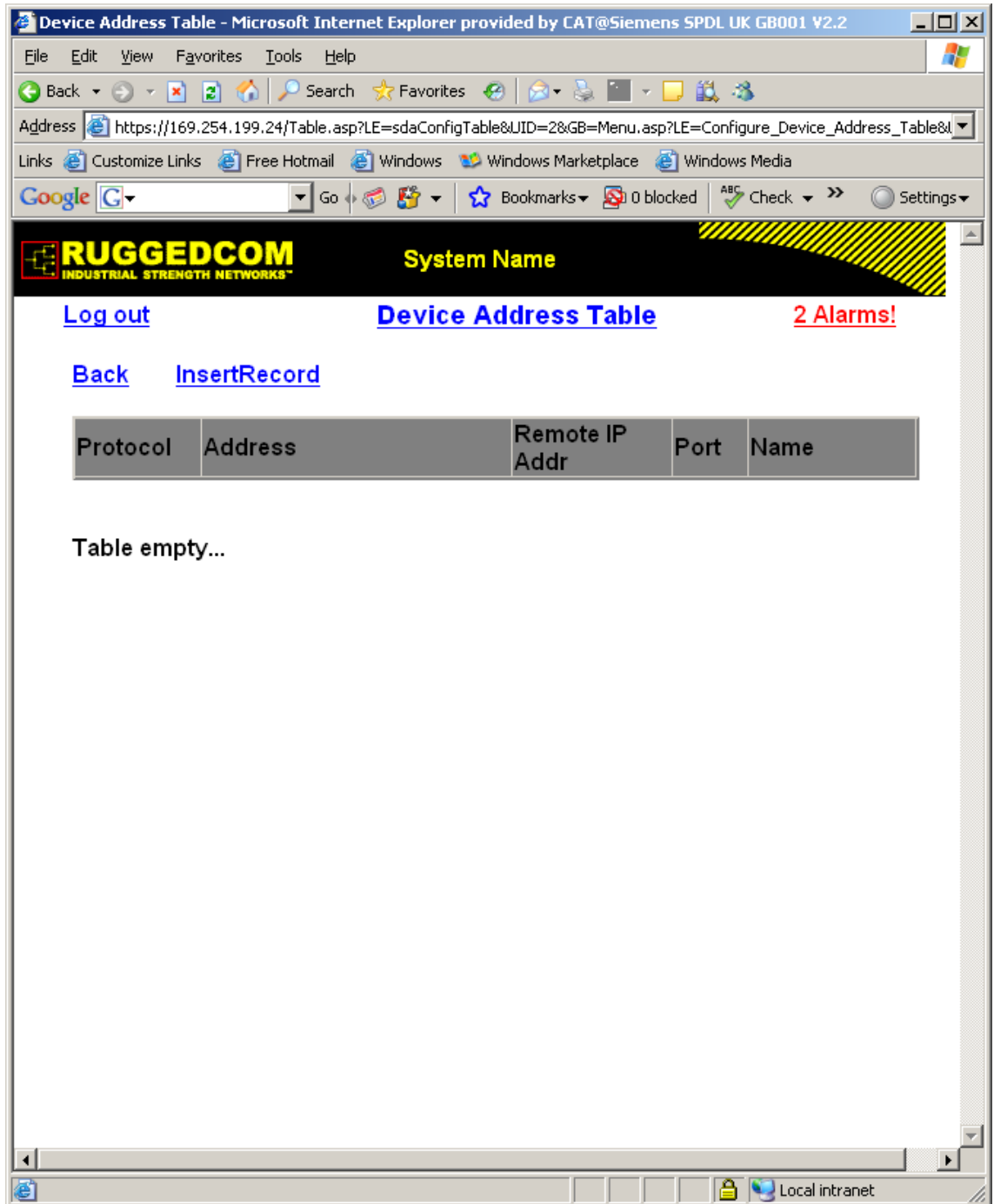

Figure 20 – RMC30 Browser Interface – Empty Device Address Table Page

Click **Insert Record** to open the editor page.

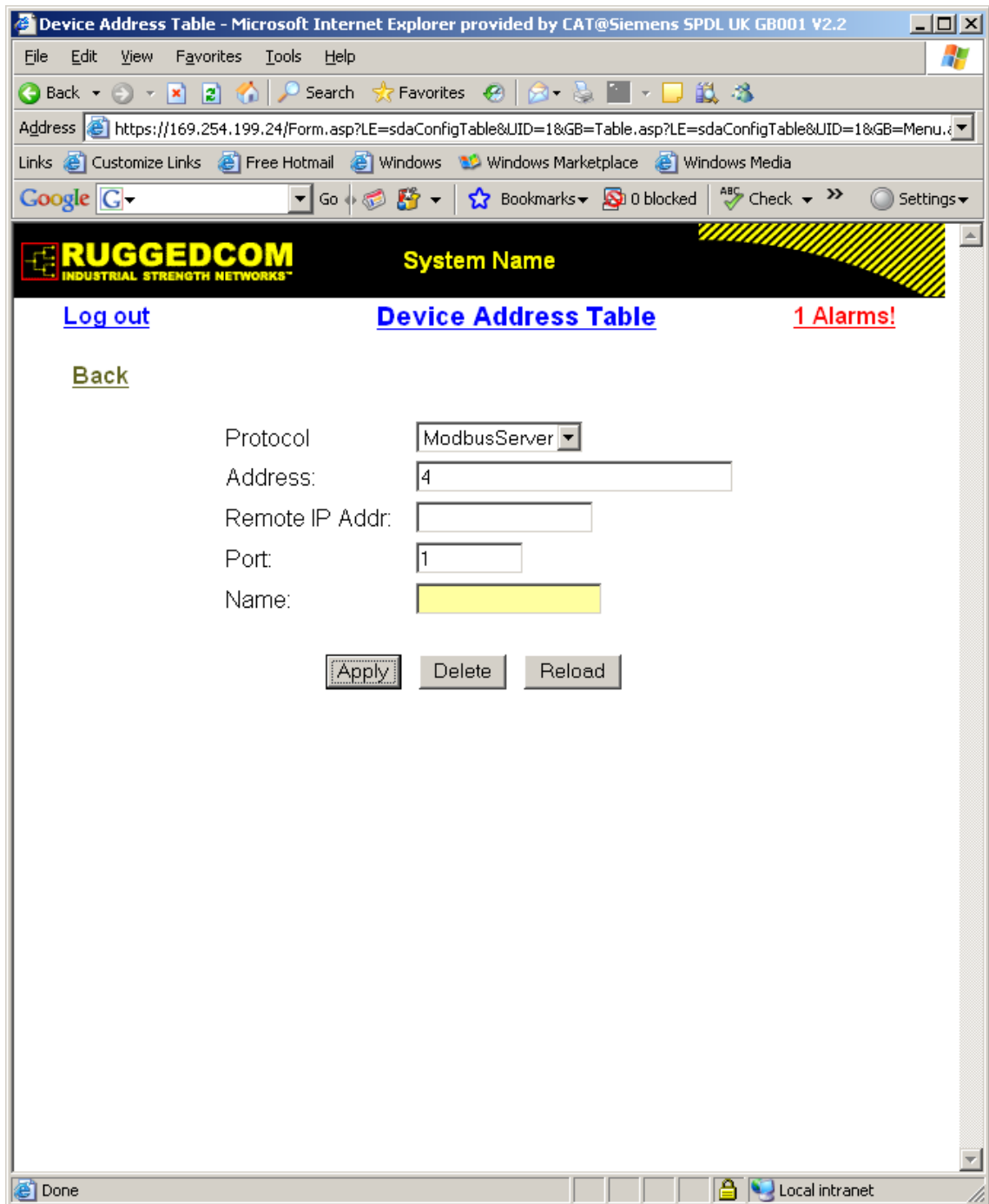

Figure 21 – RMC30 Browser Interface – Device Address Editor Page

Set the protocol to MODBUS Server, address to the device address (in this example 4), and the port to 1, the RS422/485 port we configured earlier. Leaving the remote IP address field blank will cause the address we set earlier to be used. Click apply to save the settings, then back to return to the table.

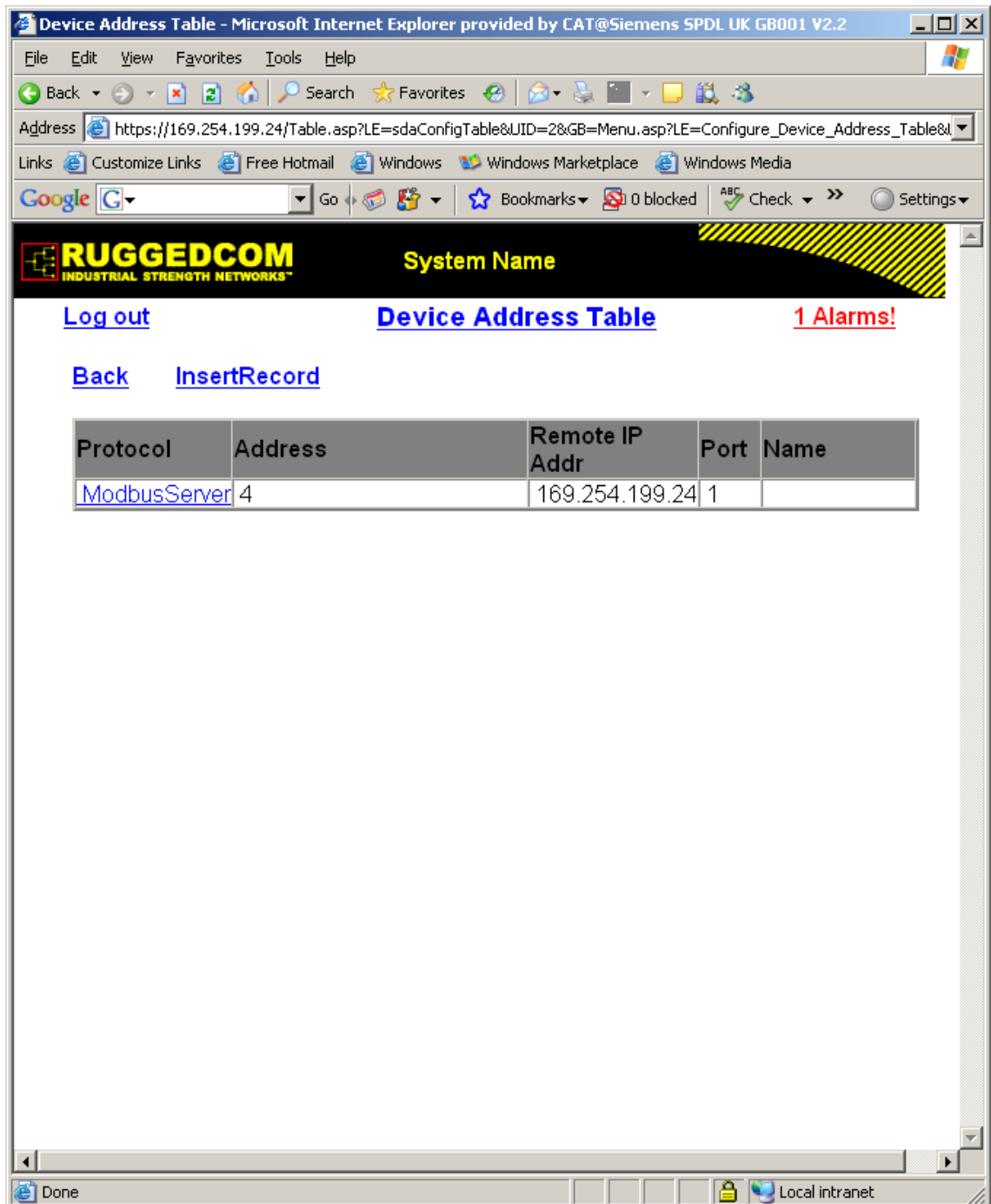

Figure 22 – RMC30 Browser Interface –Populated Device Address Table Page

Now the configuration should be complete click **Log Out**. Connection can be made to the IP address using the default MODBUS client port number of 502. If you need to change this parameter open the Configure Protocols branch, see Figure 17 – RMC30 Browser Interface – Serial Protocols Menu, select MODBUS client and change the IP Port number.

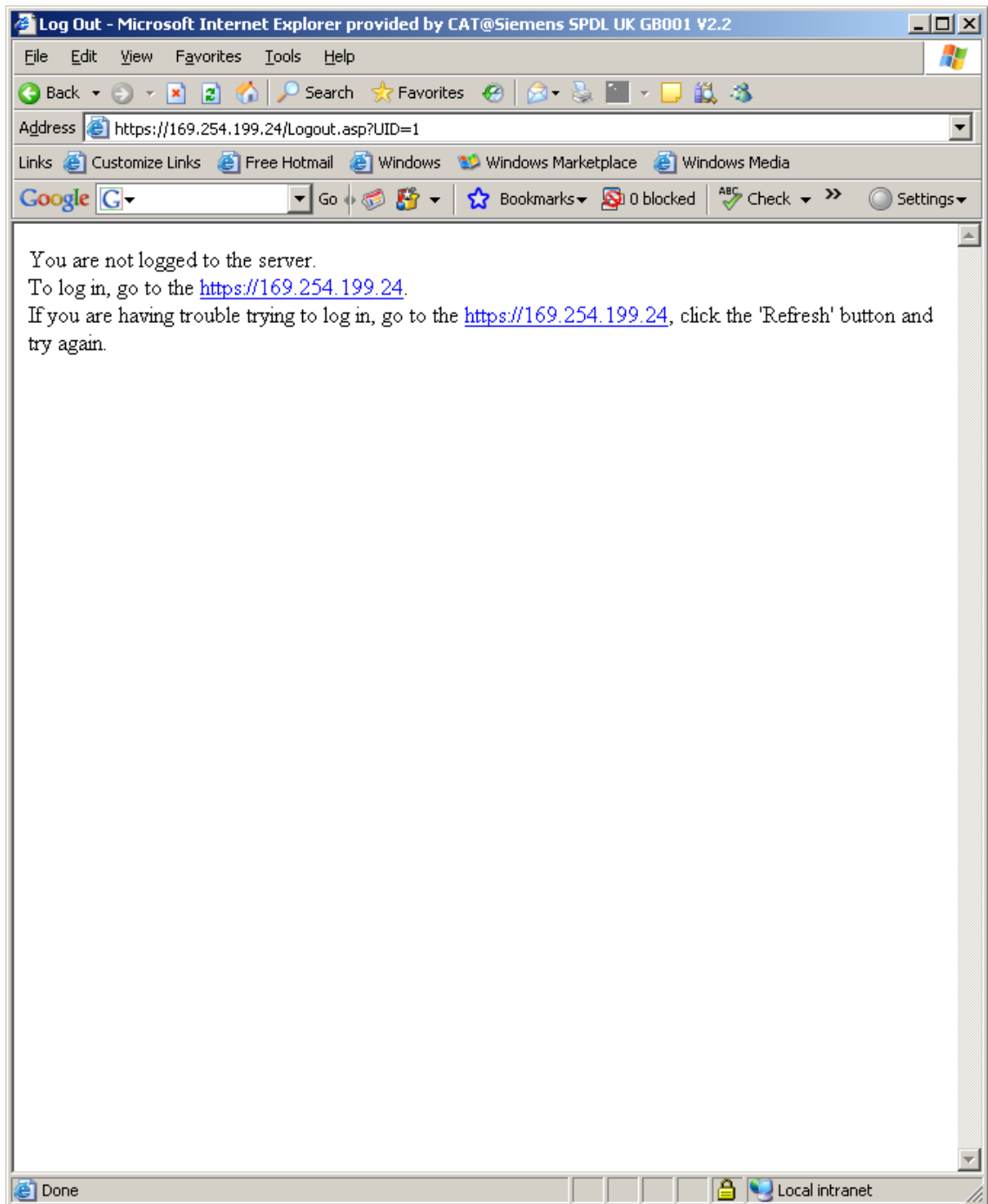
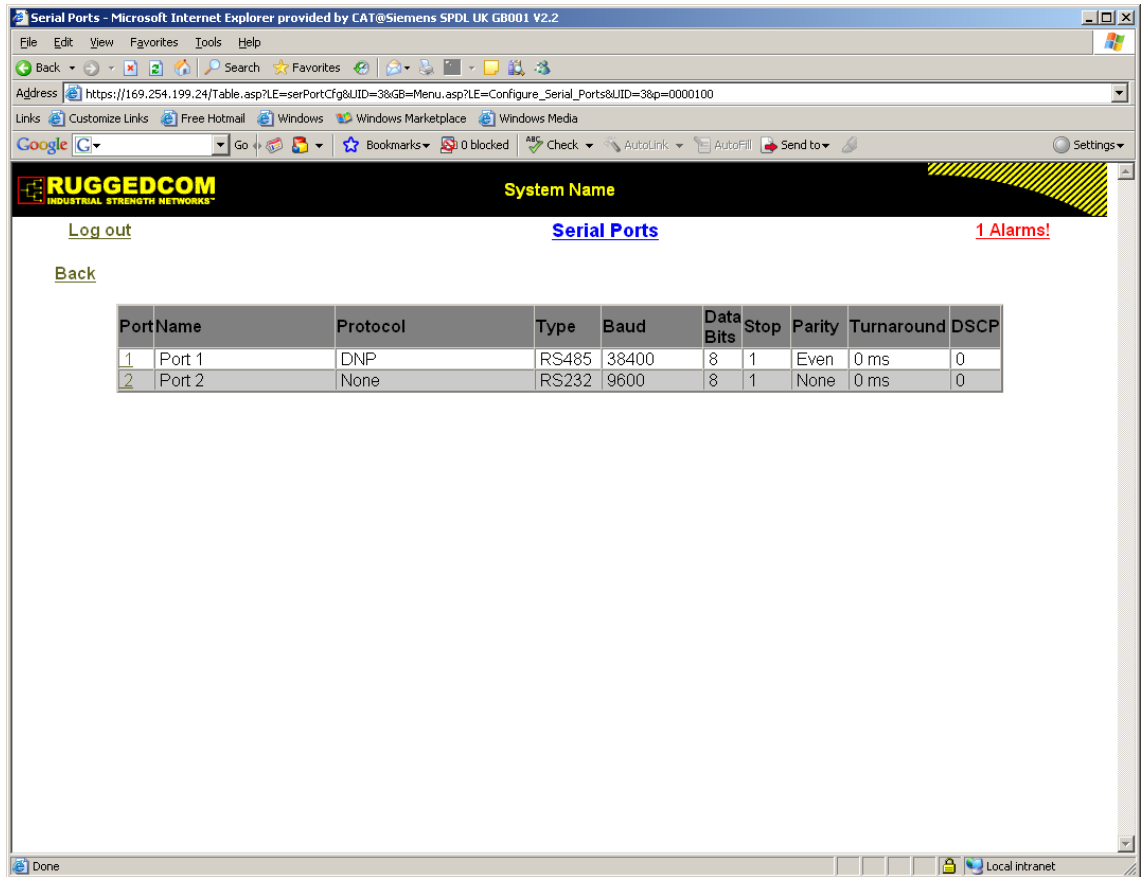

Figure 23 – RMC30 RMC30 Browser Interface –Logged Out Page

### 3.3 CONFIGURE RMC30 DNP3 PARAMETERS

If you have not already done so, set the IP address as described in section 3.1.

After setting the IP address start the web browser and login. From the Main Menu open the Serial Protocols page, refer back to *Figure 17 – RMC30 Browser Interface – Serial Protocols Menu*. Then click Serial ports. Set the protocol to be DNP3 and the baud rate, parity etc. to be those you intend to use with the relay, see example below.



**Figure 24 – RMC30 Browser Interface – Serial Port for DNP3**

Click the link “**Back**” to return to the Main Menu and then click Configure Device Address Table to add devices.

You need to add two devices, one for the PC (or Master) and one for the IED device.

In the example shown below I have given the PC address 3 and used its IP address (169.254.199.21) when adding to the table.

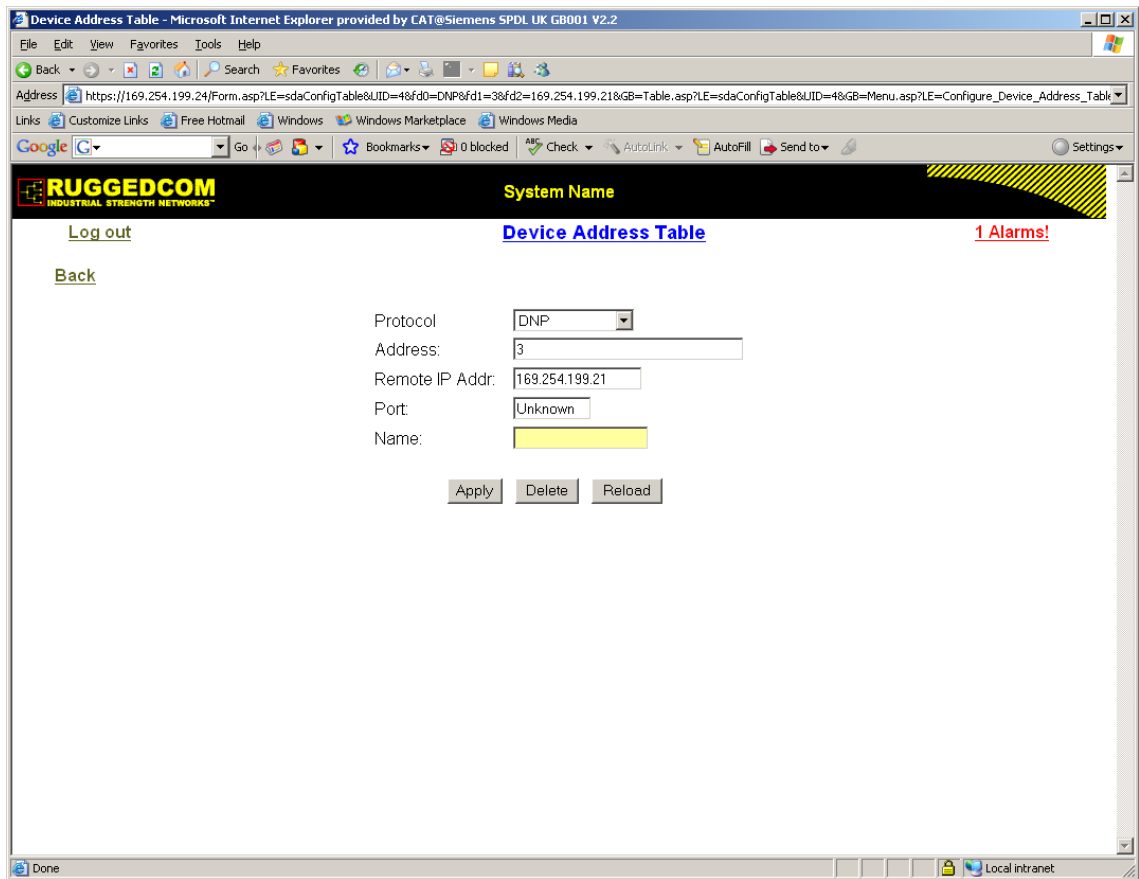

Figure 25 – RMC30 Browser Interface – PC DNP3 Device Entry

The IED was connected to communications port 1 (RS485). The address on the IED was set to 4. The IP address is that of the RMC30, in this instance 169.254.199.24.



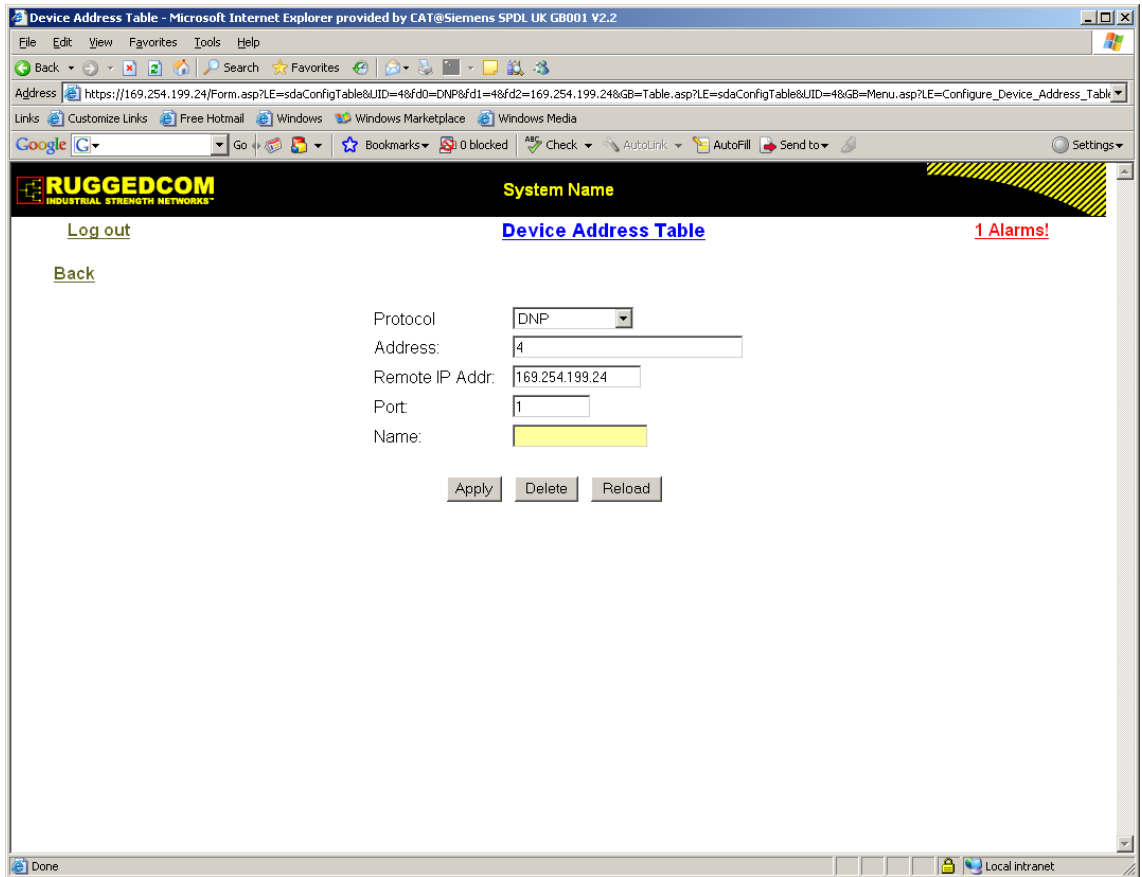

Figure 26 – RMC30 Browser Interface – IED DNP3 Device Entry

Click Back and the table should now look some thing like the one shown below in Figure 27.

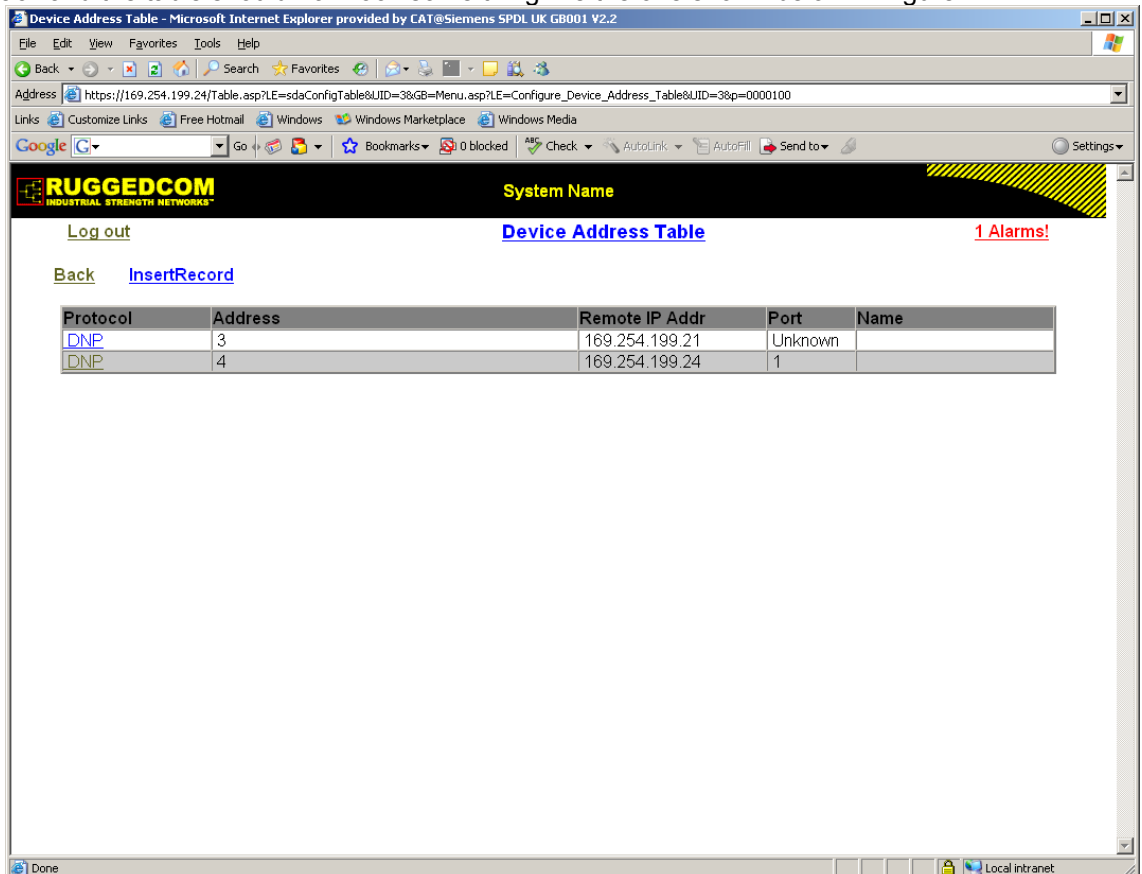

Figure 27 – RMC30 Browser Interface – IED DNP3 Device Entry

That completes configuration for the RMC30 in DNP3 mode, click **Log Out**. Connection can be made to the IP address using the default DNP3 client port number of 20000. If you need to change this parameter open the Configure Protocols branch, see *Figure 17 – RMC30 Browser Interface – Serial Protocols Menu*, select DNP client and change the IP Port number.

### 3.4 CONFIGURE RMC30 TUNNEL PARAMETERS

If you have not already done so, set the IP address as described in section 3.1.

After setting the IP address start the web browser and login. From the Main Menu open the Serial Protocols page, refer back to *Figure 17 – RMC30 Browser Interface – Serial Protocols Menu*. Then click Serial ports. Set the protocol to be Raw Socket and the baud rate to be those you intend to use with the relay, see example shown below in Figure 28.

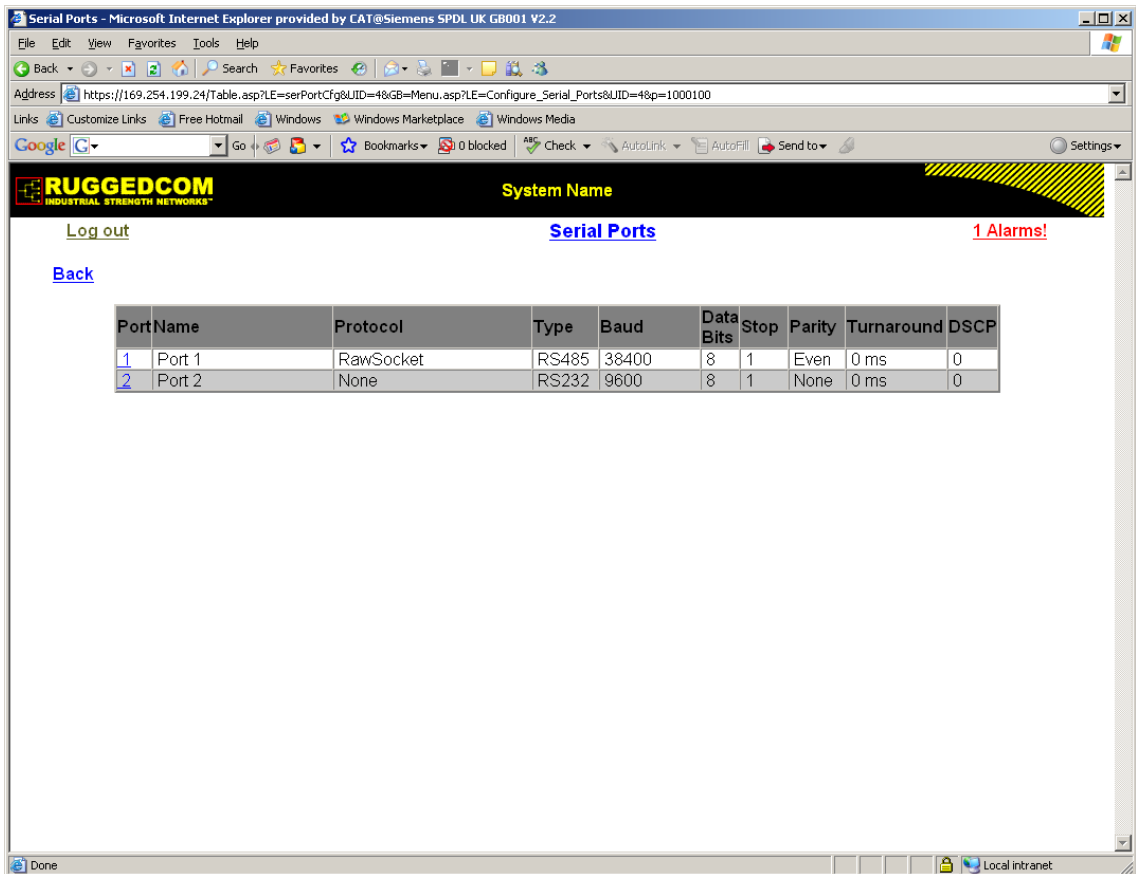

Figure 28 – RMC30 Browser Interface – Serial Port for Raw Socket

That completes configuration for the RMC30 in Tunnel mode, click **Log Out**. In this mode you do not need to add any devices to the Device Table. Connection can be made to the IP address using the default Raw Socket client port number of 50001. If you need to change this parameter open the Configure Protocols branch, see *Figure 17 – RMC30 Browser Interface – Serial Protocols Menu*, select Raw Socket and change the Loc Port number.

## Section 4: Definitions

### 4.1 INTRODUCTION

This note does not cover the DNP3 or MODBUS data point definitions. For detailed information about the data types available, for example Events; Measurands; Commands etc, refer to the Data Communications section of the relevant product manual.

The information regarding the RMC30 device was taken from the following document

- [1] Rugged Operating System v3.2 User Guide

## Section 5: Glossary

### **Baud Rate**

Data transmission speed.

### **Bit**

The smallest measure of computer data.

### **Bits Per Second (bps)**

Measurement of data transmission speed.

### **Data Bits**

A number of bits containing the data. Sent after the start bit.

### **Data Echo**

When connecting relays in an optical ring architecture, the data must be passed from one relay to the next, therefore when connecting in this method all relays must have the Data Echo ON.

### **Half-Duplex Asynchronous Communications**

Communications in two directions, but only one at a time.

### **Hayes 'AT'**

Modem command set developed by Hayes Microcomputer products, Inc.

### **Line Idle**

Determines when the device is not communicating if the idle state transmits light.

### **Modem**

MOdulator / DEModulator device for connecting computer equipment to a telephone line.

### **Parity**

Method of error checking by counting the value of the bits in a sequence, and adding a parity bit to make the outcome, for example, even.

### **Parity Bit**

Bit used for implementing parity checking. Sent after the data bits.

### **RS232C**

Serial Communications Standard. Electronic Industries Association Recommended Standard Number 232, Revision C.

### **RS485**

Serial Communications Standard. Electronic Industries Association Recommended Standard Number 485.

### **Start Bit**

Bit (logical 0) sent to signify the start of a byte during data transmission.

### **Stop Bit**

Bit (logical 1) sent to signify the end

### **USB**

Universal Serial Bus standard for the transfer of data.

## Section 6: Appendix

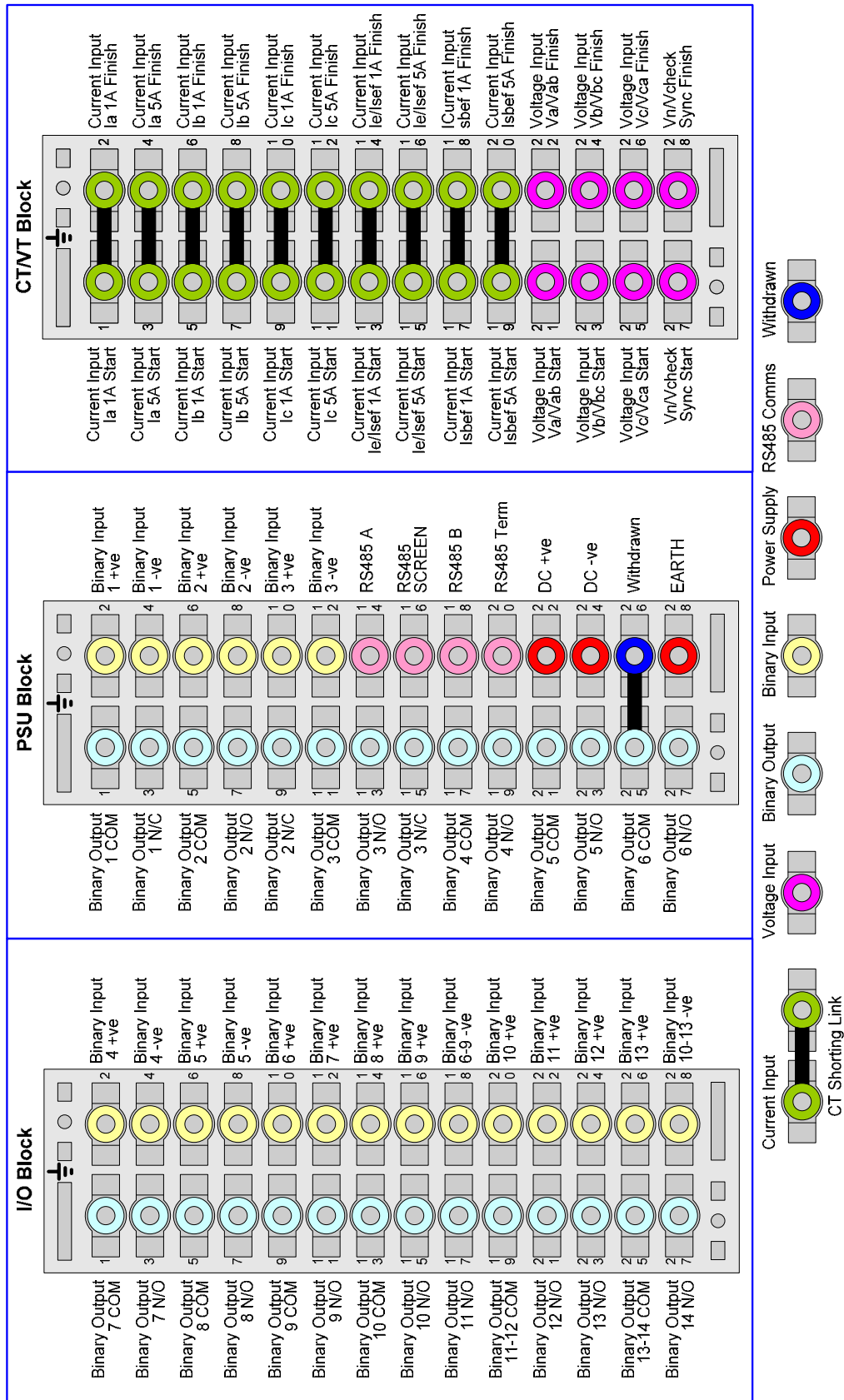

Figure 29 – Rear Terminals for E8 case (5CT/4VT)