



# Contact Information

## Sales office

- Prices / delivery times
- Technical questions
- Repairs / returns

UK: 08458 507600  
IRE: 1890 507600  
E-mail: [Sales.gbi.industry@siemens.com](mailto:Sales.gbi.industry@siemens.com)  
(Product Sales, Quotes, Order & Delivery)

## Technical Support hotline

- Technical support
- FAQ
- Service

UK: 08458 507600  
IRE: 1890 507600  
Email: [Service.gbi.industry@siemens.com](mailto:Service.gbi.industry@siemens.com)  
(Technical Support, Spares & Service Engineers)

## Training

- Courses
- Training

UK & IRE: 0161 446 6111  
Email: [training.ad.uk@siemens.com](mailto:training.ad.uk@siemens.com)

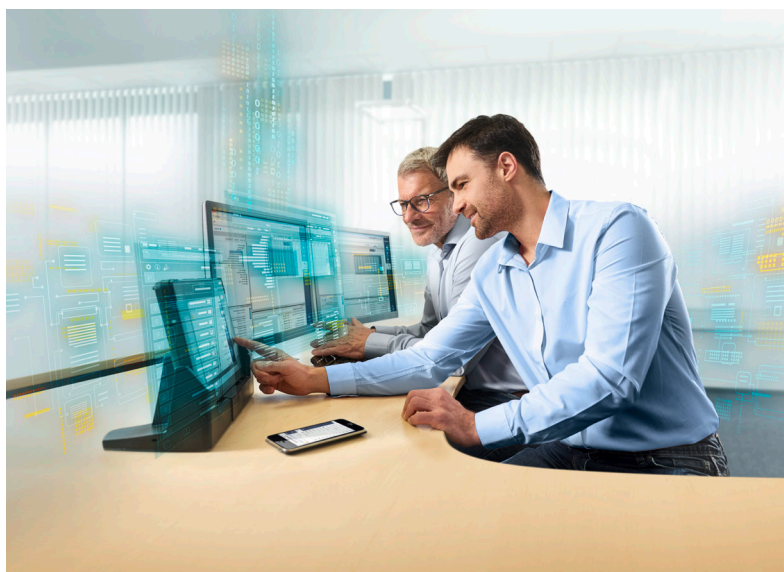

Prices valid until 31/10/2022\*

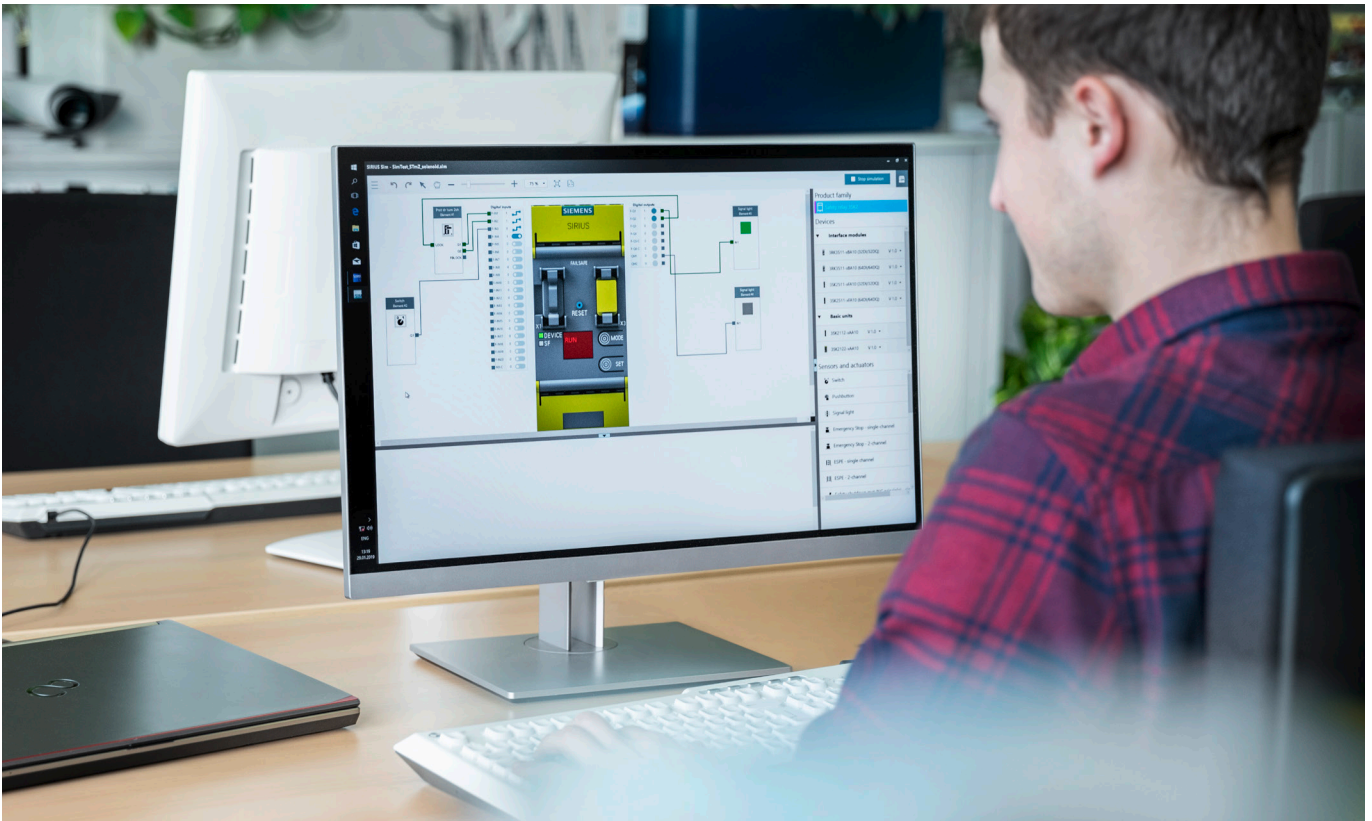







## Index

<b>Contact information</b>	<b>2</b>	<b>Non-contact safety switches</b>	<b>22</b>
<b>Product Guide</b>	<b>4</b>	<b>(Emergency-stop) pushbuttons &amp; signalling lamps - flush mount</b>	<b>22</b>
<b>Safety relays</b>	<b>6</b>	<b>(Emergency-stop) pushbutton enclosures surface mount</b>	<b>25</b>
<b>Paramaterisable safety relays</b>	<b>7</b>	<b>Pushbuttons with Profinet</b>	<b>26</b>
<b>Motor Starters</b>	<b>8</b>	<b>Application examples &amp; reference materials</b>	<b>28</b>
<b>Failsafe Soft Starters</b>	<b>10</b>	<b>Safety lifecycle services</b>	<b>38</b>
<b>Contactors for safety applications</b>	<b>12</b>	<b>AS-interface - ASIsafe safety module</b>	<b>40</b>
<b>Position switches and safety position switches</b>	<b>14</b>	<b>Failsafe motor management system</b>	<b>40</b>
<b>Gate lock switches</b>	<b>17</b>	<b>Failsafe controllers</b>	<b>40</b>
<b>Gate monitoring switches</b>	<b>18</b>	<b>Failsafe drives</b>	<b>40</b>
<b>Cable-operated switches</b>	<b>18</b>	<b>Safety Evaluation Tool: Online SIL (EN 62061) and PL (EN ISO 13849) calculation for safety functions</b>	<b>41</b>
<b>Hinge switches</b>	<b>20</b>	<b>Functional connection examples for machine safety applications</b>	<b>41</b>
<b>Foot switches</b>	<b>20</b>	<b>B10 values of SIRIUS components</b>	<b>41</b>
<b>Two-hand operation consoles</b>	<b>20</b>		
<b>Signalling columns</b>	<b>21</b>		









# Product Guide

## 3SK1 Input Capability

Type	Part number	E-Stop 	Gate 	Light Curtain 	Two Hand Control 	N/O Contacts (Gate Interlock) 	Expandable Inputs using Device Connectors 
Standard with Relay Enabling Contacts	3SK1111-*A**0	✓	✓	✓	-	-	-
Standard with Solid State Enabling Contacts	3SK1112-*BB40	✓	✓	✓	-	-	-
Advanced with Relay Enabling Contacts	3SK1121-*AB40	✓	✓	✓	✓	✓	✓
	3SK1121-*CB4*	✓	✓	✓	✓	✓	✓
Advanced with Solid State Enabling Contacts	3SK1120-*AB40	✓	✓	✓	✓	✓	✓
	3SK1122-*AB40	✓	✓	✓	✓	✓	✓
	3SK1122-*CB4*	✓	✓	✓	✓	✓	✓
Input Sensor Expansion Unit	3SK1220-1AB40	✓	✓	✓	✓	✓	✓

## 3SK1 Output Capability

Type	Part number	Relay Enabling Contacts (n/o) 	Solid State Enabling Contacts 	Signal Contact (n/c) 	Delayed Relay Enabling Contacts 	Delayed Solid State Enabling Contacts 	Expandable Outputs Using device Connectors 
Standard with Relay Enabling Contacts	3SK1111-*A**0	3	0	1	0	0	-
Standard with Solid State Enabling Contacts	3SK1112-*BB40	0	2	1	0	0	-
Advanced with Relay Enabling Contacts	3SK1121-*AB40	3	0	1	0	0	✓
	3SK1121-*CB4*	2	0	0	2	0	✓
Advanced with Solid State Enabling Contacts	3SK1120-*AB40	0	1	0	0	0	✓
	3SK1122-*AB40	0	3	1	0	0	✓
	3SK1122-*CB4*	0	2	0	0	2	✓
Output Expansion Unit	3SK1211-*BB00	4	0	1	★	0	-
	3SK1211-*BB40	4	0	1	★	0	✓
	3SK1211-*BW20	4	0	1	★	0	-
	3SK1213-*AB40	3	0	1	★	0	-
	3SK1213-*AJ20	3	0	1	★	0	✓
	3SK1213-*AL20	3	0	1	★	0	-

✓ Version compatible

- Version not compatible

★ Enabling circuits can be set to time delayed if used in conjunction with a time delayed base unit



There are many facets to machine safety. And SIRIUS 3SK can always provide a solution.

SIRIUS 3SK is a highly streamlined product portfolio. The 3SK1 range has been developed to allow fast, simple implementation of the most common safety functions. More complex safety systems can be created using basic units from the new 3SK2 series.

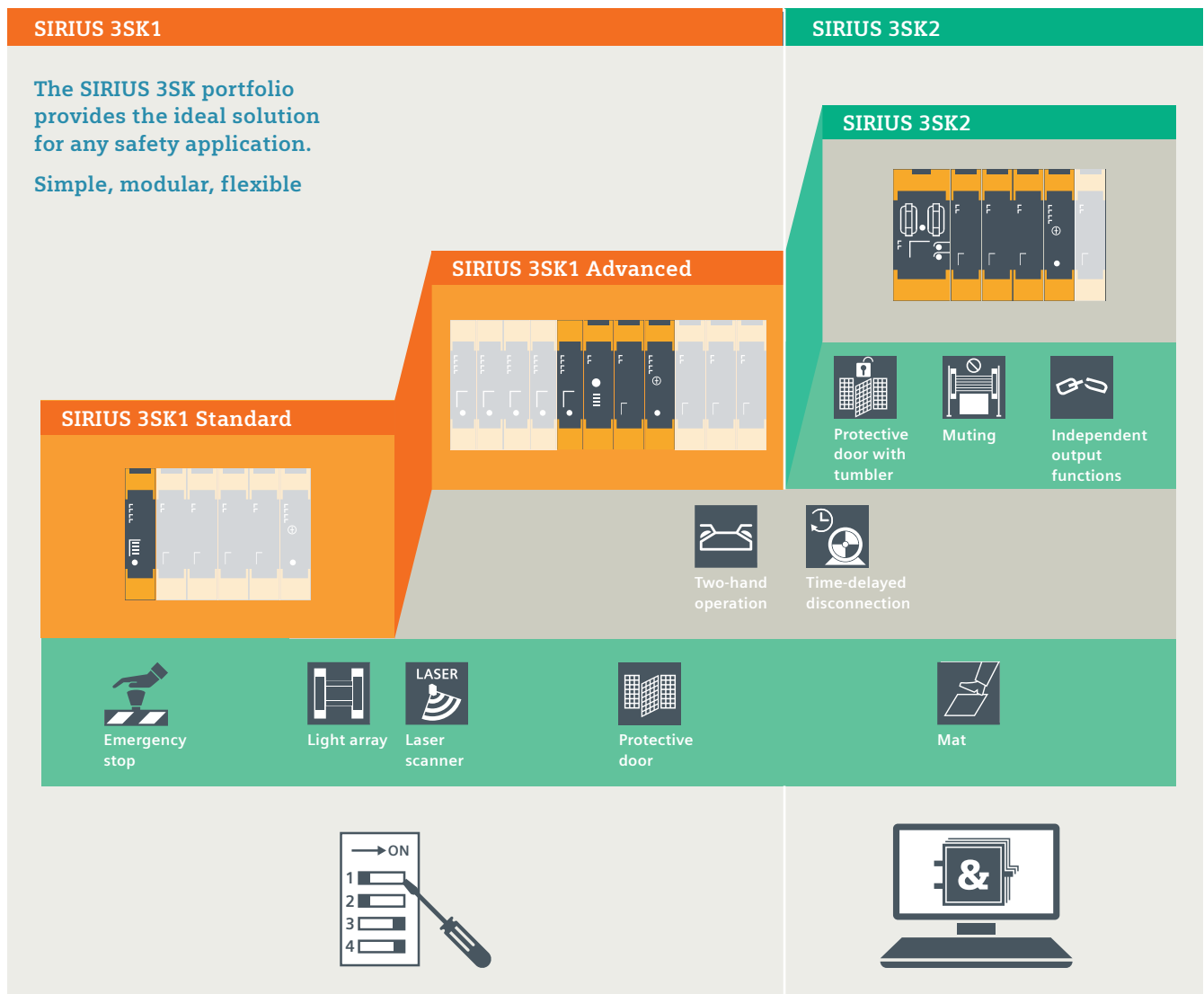

## Easy to parameterize – using DIP switches or a PC

Parameterizing safety functions with SIRIUS 3SK Safety Relays is an exceptionally simple process: you can use four DIP switches on the front panel (3SK1 units), or software (3SK2 units).

## Software benefits at a glance

- **Easy setup** of complex safety applications using the drag and drop method
- **Efficient commissioning** using test mode, forcing and extensive diagnostics
- **Faster preparation of documentation**

# Safety Relays

## SIRIUS 3SK1 Safety Relays



Description:	Fig.	Adjustable off-delay time	Rated control supply voltage	Enable circuits	Signaling circuits	Artical No. Screw-type connection ⊕	Artical No. Spring-type connection (push-in) ⊞	L Price £	Prod. group
<b>Standard basic units</b>									
With relay outputs	1	-	24 V AC/DC	3	1	3SK1111-1AB30	3SK1111-2AB30	120.77	41L
	1	-	110 - 240 V AC/DC	3	1	3SK1111-1AW20	3SK1111-2AW20	120.77	41L
With semiconductor outputs	1	-	24 V DC	2	1	3SK1112-1BB40	3SK1112-2BB40	95.92	41L
<b>Advanced basic units</b>									
With relay outputs	2	-	24 V DC	3	1	3SK1121-1AB40	3SK1121-2AB40	153.47	41L
	2	0.05 to 3 s	24 V DC	2/2tv	-	3SK1121-1CB41	3SK1121-2CB41	191.84	41L
	2	0.5 to 30 s	24 V DC	2/2tv	-	3SK1121-1CB42	3SK1121-2CB42	191.84	41L
With semiconductor outputs	2	-	24 V DC	3	1	3SK1122-1AB40	3SK1122-2AB40	115.10	41L
	2	0.5 to 30 s	24 V DC	2/2tv	-	3SK1122-1CB42	3SK1122-2CB42	115.10	41L
<b>Input expansion module 17.5 mm</b>									
Sensor expansion module for safety-oriented expansion of the Advanced basic units by adding an additional 2-channel sensor or two 1-channel sensors	3	-	24 V DC	-	-	3SK1220-1AB40	3SK1220-2AB40	92.00	41L
<b>Output expansion module 4RO 22.5 mm</b>									
With relay outputs	4	-	24 V DC	4	1	3SK1211-1BB40	3SK1211-2BB40	111.62	41L
<b>Device connectors for saving wiring for Advanced basic units, input or output expansion modules</b>									
Device connector, 17.5 mm	5	-	-	-	-	3ZY1212-1BA00	-	11.25	41L
Device connector, 22.5 mm	5	-	-	-	-	3ZY1212-2BA00	-	11.25	41L
Device termination connector, 22.5 mm	5	-	-	-	-	3ZY1212-2DA00	-	12.08	41L
<b>Power supply for 3SK1 advanced and 3SK2 series</b>									
Power supply, Spring-type connection	6	-	110- 240 V AC/DC	-	-	3SK1230-1AW20	-	76.30	41L
Power supply, Screw connection	7	-	110- 240 V AC/DC	-	-	3SK1230-2AW20	-	76.30	41L

For application examples and circuit diagrams please refer to Page 28

## SIRIUS 3TK28 Safety Relays\*

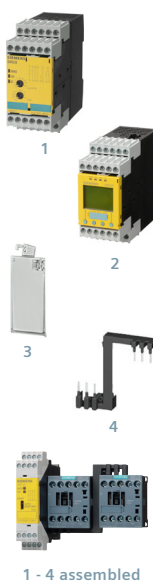

Description:	Fig.	Order number	L Price £	Prod. group
<b>Standstill monitoring safety relay, Cat.4 / SIL 3 / PL e, IP20, screw terminal</b>				
<ul style="list-style-type: none"> <li>Suitable for three-phase motors, max. 690 V AC.</li> <li>Sensorless measuring principle (residual induction voltage principle).</li> </ul>				
3NO+1NC release circuits, 1CO+1DO mess. output, sens. 20-400mV, switch-off time adj. 0.2-6 sec, 24 VDC	1	3TK2810-0BA01	657.19	41L
<b>RPM / standstill monitoring safety relay with integrated gate monitoring function, SIL 3 / PL e, IP20, screw terminal</b>				
<ul style="list-style-type: none"> <li>For PNP, NPN sensors and Cos/Sin, TTL / HTL encoders, inst. 1Hz-400kHz</li> <li>Integrated gate monitoring function for connecting to gate (locking) switches</li> </ul>				
2NO release circuits, 2NO mess. output, 1 encoder + 2 sensor inputs, conn. to gate monitoring sw., 24 VDC	2	3TK2810-1BA41	1062.57	41L
2NO release circuits, 2NO mess. output, 1 encoder + 2 sensor inputs, conn. to gate mon. sw., 110-240V AC/DC	2	3TK2810-1KA41	1093.28	41L
<b>Accessories for safety relays</b>				
Sealable cover against unauthorized changing of settings, for 3TK2820 safety relays	3	3TK2820-0AA00	2.19	41L
Sealable cover against unauthorized changing of settings, for 3TK2826 safety relays	3	3TK2826-0DA00-0HA0	4.97	41L
Sealable cover against unauthorized changing of settings, for other 3TK28 models	3	3RP1902	3.31	41H
Connecting / copying cable for 3TK2810.1 rpm monitor to encoder (RJ 45-cross cable)		3TK2810-0A	25.55	41L
Adapter for connecting 15-pole encoder to 3TK2810.1 rpm monitor		3TK2810-1A	77.39	41L
Adapter for connecting 25-pole encoder to 3TK2810.1 rpm monitor		3TK2810-1B	85.99	41L
<b>Safety connector</b>				
For mounting 2 contactors side by side in series for redundant switching.				
For SIRIUS contactors, series 3RT2.1, screw terminals (size S00)	4	3RA2916-1A	10.44	41B
For SIRIUS contactors, series 3RT2.2, screw terminals (size S0)	4	3RA2926-1A	10.44	41B

\*For more models and comprehensive technical information, please see the Industrial Controls catalogue: IC 10 2020. For the latest information, visit the Industry Mall: [www.siemens.com/industrymall/gb](http://www.siemens.com/industrymall/gb)

# Paramaterisable Safety Relays

## SIRIUS 3SK2\* Safety Relays

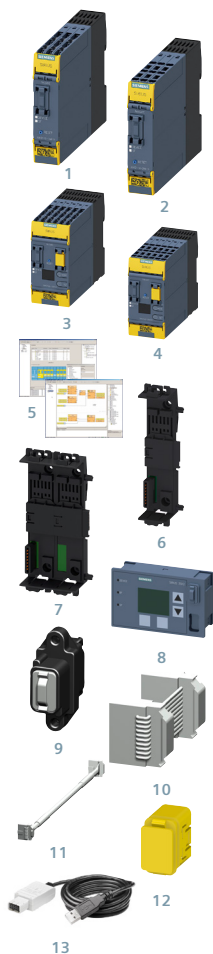

Description:	Fig.	Order number	L Price £	Prod. group
Basic Unit 3SK2 Series 10 F-DI, 2 F-DQ, 1 DQ, 24 V DC, 22.5mm Screw connection	1	3SK2112-1AA10	236.31	41L
Basic Unit 3SK2 Series 10 F-DI, 2 F-DQ, 1 DQ, 24 V DC, 22.5mm Spring-type connection	2	3SK2112-2AA10	236.31	41L
Basic Unit 3SK2 Series 20 F-DI, 4 F-DQ, 2 DQ, 24 V DC, 45mm Screw connection	3	3SK2122-1AA10	347.49	41L
Basic Unit 3SK2 Series 20 F-DI, 4 F-DQ, 2 DQ, 24 V DC, 45mm Spring-type connection	4	3SK2122-2AA10	347.49	41L
Device connector, 22.5mm	6	3ZY1212-2GA00	11.25	41L
Device connector, 45mm	7	3ZY1212-4GA01	13.73	41L
Safety ES Standard Parameterisation software for 3SK2 + MSS, incl 1. floating licence	5	3ZS1316-5CC10-0YA5	423.88	42B
<b>Accessories for 3SK2 safety relays</b>				
Diagnostic display for 3KS2 and MSS suitable for front mounting in panel or in switch box (dimensions 60x96mm)	8	3SK2611-3AA00	227.59	41L
Door adapter for mounting in cubicle door	9	3UF7920-0AA00-0	15.09	42J
Connection cable (flat) for connecting 3SK2 or MSS to diagnostic display, 0.1m	10	3UF7931-0AA00-0	7.53	42J
Connection cable (flat) for connecting 3SK2 or MSS to diagnostic display, 0.3m	10	3UF7935-0AA00-0	9.90	42J
Connection cable (flat) for connecting 3SK2 or MSS to diagnostic display, 0.5m	10	3UF7932-0AA00-0	11.60	42J
Conenction cable (round) for connecting 3SK2 or MSS to diagnostic display, 0.5m	11	3UF7932-0BA00-0	22.36	42J
Connection cable (round) for connecting 3SK2 or MSS to diagnostic display, 1m	11	3UF7937-0BA00-0	25.06	42J
Connection cable (round) for connecting 3SK2 or MSS to diagnostic display, 2.5m	11	3UF7933-0BA00-0	27.69	42J
3SK2 & MSS memory module spare part	12	3RK3931-0AA00	23.52	42C
USB Cable for connecting the 3SK2 to the PC/PG interface	13	3UF7941-0AA00-0	82.78	42J

## 3SK2 User-friendly safety relays



- Sirius 3SK2 with up to six safety functions that can be parameterized using software
- User-friendly software interface - create complex safety applications simply thanks to drag & drop functionality
- Most compact software-parameterisable safety relay on the market

The Sirius 3SK2 safety relay from Siemens offers multiple safety functions in the smallest of spaces. Thanks to the user-friendly drag & drop parameterization interface, it is simple to create safety functions that can be optionally expanded to include test and diagnostics functions. Sirius 3SK2 safety relays come in two different variants – the 22.5-millimeter-wide device, which comes with up to four safety functions, is slimmer than any other software-parameterisable safety relay currently available on the market, while the 45-millimeter-wide device, which offers up to six safety functions, comes equipped with a diagnostics display. The functions of the 3SK2 fail-safe outputs can be assigned independently of each other.

Typical applications for Sirius 3SK2 devices include emergency stop pushbuttons, protective doors with tumblers, or material feeder systems with light barrier sensor technology. Additional safety applications are simple to implement for specific requirements. The fail-safe outputs can be supplemented in a modular fashion as required – even without additional wiring. Just like devices in the Sirius 3SK1 series, Sirius 3SK2 units are simple to combine with conventional industrial controls, for example, devices from the Sirius 3RM1 motor starter range can be simply integrated using device connectors.

\*For more models and comprehensive technical information, please see the Industrial Controls catalogue: IC 10 2020. For the latest information, visit the Industry Mall: [www.siemens.com/industrymall/gb](http://www.siemens.com/industrymall/gb)



# Motor Starters

Software Safety ES: Hardware and software advancement in programmes (Safety Relays continued)

Software Safety ES: Hardware and software structure in one program.

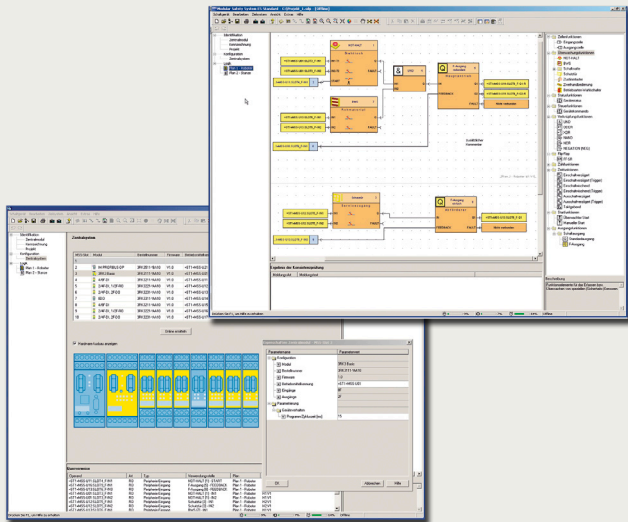

The complete project documentation is generated automatically.

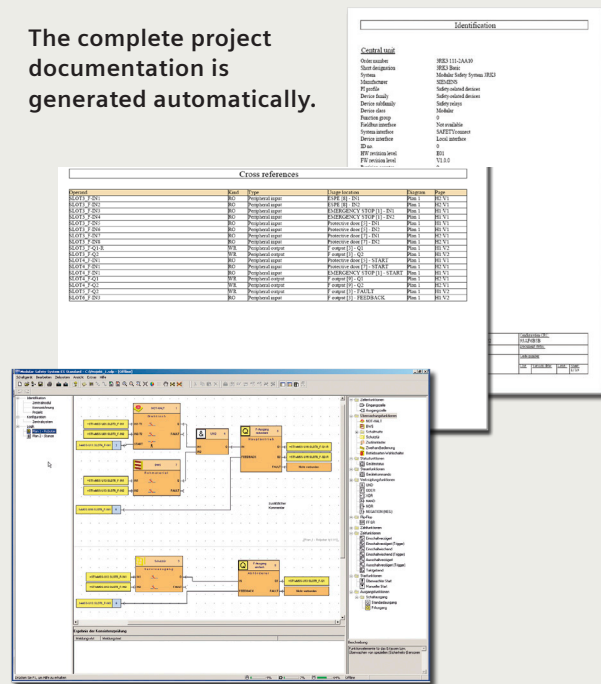

Getting started – even when things get tight SIRIUS 3RM1 Motor Starters



Space-saving systems require maximum efficiency and can pose significant challenges for system engineers. Systems and machinery are becoming increasingly compact and are expected to have smaller footprints, but at the same time they typically require more auxiliary drives. Because every inch counts in a control cabinet, SIRIUS 3RM1 Motor Starters are precisely tailored to meet these requirements and represent the solution for the development of cutting-edge and future-oriented systems.

Their innovative housing concept even received the internationally renowned iF product design award 2013. It's easy to get started: The new motor starters are so narrow that they fit into the smallest space.

**In brief: SIRIUS 3RM1 Motor Starters – multifunctional with a width of just 22.5 mm.**

*Direct or reversing starting – with SIRIUS 3RM1 Motor Starters, you can implement compact control cabinet solutions for small motors up to 3 kW.*

In a width of just 22.5 mm there is now room for so many functions

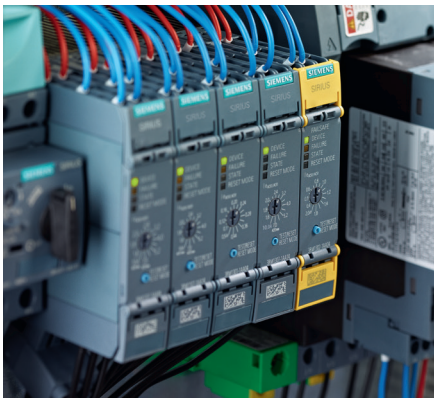

## Narrow width

The motor starters are distinguished by their narrow width of just 22.5 mm. That saves room in the control cabinet and provides the ideal conditions for systems and machines with many small motors up to 3 kW.

Even subsequent expansions are easier to plan and implement: If more motors are needed in the system, thanks to their narrow width it's easy to add additional SIRIUS 3RM1 Motor Starters to the ones already installed in the control cabinet.

## Multifunctional

### Direct and reversing starters

Motor starters are available as direct starters or with a reversing starter function, all in a uniform housing design. The operation, configuration, and the width for both device types are identical.

### Overload protection

Every motor starter is equipped with integrated electronic overload protection. In other words, you no longer need a separate overload relay when you use these motor starters. The result is lower wiring costs, shorter installation time and more room on the DIN rail.

## Safe shutdown

To meet the requirements for safe shutdowns, SIRIUS 3RM1 Motor Starters are also available in a safety version. They can be used in combination with the modular safety relays to easily implement locally limited safety applications.

The motor starters for safe shutdowns are available as direct and reversing starters. They are certified in accordance with SIL 3/PL e Cat. 4.

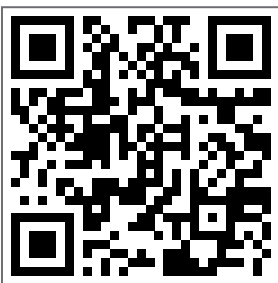

Scan and learn more about space savings in control cabinets!

## SIRIUS 3RM1 Motor Starter - Order number overview

Order no.					Three-phase standard motor <sup>1</sup>	Adjustment range	L Price £	Prod. group
					Standard power rating P	Electronic overload releas		
3RM1	01	AA	4		0 ... 0.12 kW	0.1 ... 0.5 A		
3RM1	02	AA	4		0.09 ... 0.75 kW	0.4 ... 2.0 A		
3RM1	07	AA	4		0.55 ... 3 kW	1.6 ... 7.0 A, (10 A) <sup>2</sup>		
			0		DC 24 V	Rated control supply voltage Vs		
			1		AC 110 ... 230 V; DC 110 V			
		1			Screw-type connection Spring-loaded connection Mixed connection technology	Connection technology		
		2						
		3						
	0				Direct starter	Function	143.16	41D
	1				Failsafe direct starter		165.70	41D
	2				Reversing starter		156.42	41D
	3				Failsafe reversing starter		178.96	41D

1) Base 4-pin with AC 400 V; the concrete start-up and rated data of the motor should be taken into consideration for the selection

2) Operation of ohmic loads with a maximum of 10 A

3) Mixed connection technology: control circuit implemented as a push-in spring-loaded connection and main circuit as a screw-type connection

# Failsafe Soft Starters

## Power Contactors for Switching Motors - SIRIUS 3RT1



1



2

Description:	Fig.	Order number	L Price £	Prod. group
<b>With two removable laterally mounted auxiliary switches (Busbar Control and auxiliary circuit: screw terminal)</b>				
SIRIUS soft starter 200-480 V 13 A, 5.5Kw 24 V AC/DC Screw terminals Fail-safe	1	3RW5513-1HF04	802.50	42S
SIRIUS soft starter 200-480 V 18 A, 7.5Kw 24 V AC/DC Screw terminals Fail-safe	1	3RW5514-1HF04	892.50	42S
SIRIUS soft starter 200-480 V 25 A, 11Kw 24 V AC/DC Screw terminals Fail-safe	1	3RW5515-1HF04	990.00	42S
SIRIUS soft starter 200-480 V 32 A, 15Kw 24 V AC/DC Screw terminals Fail-safe	1	3RW5516-1HF04	1102.50	42S
SIRIUS soft starter 200-480 V 38 A, 18.5Kw 24 V AC/DC Screw terminals Fail-safe	1	3RW5517-1HF04	1230.00	42S
SIRIUS soft starter 200-480 V 47 A, 22Kw 24 V AC/DC Screw terminals Fail-safe	2	3RW5524-1HF04	1395.00	42S
SIRIUS soft starter 200-480 V 63 A, 30Kw 24 V AC/DC Screw terminals Fail-safe	2	3RW5525-1HF04	1552.50	42S
SIRIUS soft starter 200-480 V 77 A, 37Kw 24 V AC/DC Screw terminals Fail-safe	2	3RW5526-1HF04	1725.00	42S
SIRIUS soft starter 200-480 V 93 A, 45Kw 24 V AC/DC Screw terminals Fail-safe	2	3RW5527-1HF04	1890.00	42S

### 3RW55 Failsafe - Highlight Features

- Tested and certified solutions
- Savings on components and wiring
- Safe Torque Off (STO) disconnects power supply for motors with uncontrolled stopping
- Restart interlock prevents unwanted restarts



\* For all standard low-voltage equipment please refer to our SIRIUS Shortform catalogue 2022.



# Failsafe Soft Starters

## Failsafe soft starters with integrated Safe Torque Off (STO) - SIRIUS 3RW55

The integrated Safe Torque Off (STO) function in the new SIRIUS 3RW55 Failsafe soft starter effectively ensures that the motor can no longer provide any torque-generated energy in the event of an emergency. The motor comes to a standstill and remains safely in this state until it is restarted (restart interlock). In this way STO facilitates risk-free working, even when the protective door is open, making it popular in processing machine applications and systems such as agitators or belt conveyors.

The SIRIUS 3RW55 Failsafe soft starter is certified according to ATEX/IECEX directives and ideal for starting explosion-proof motors. It can also be easily integrated into the Totally Integrated Automation Portal (TIA Portal).

### Wiring example for SIL 1 and SIL 3 / PL e application:

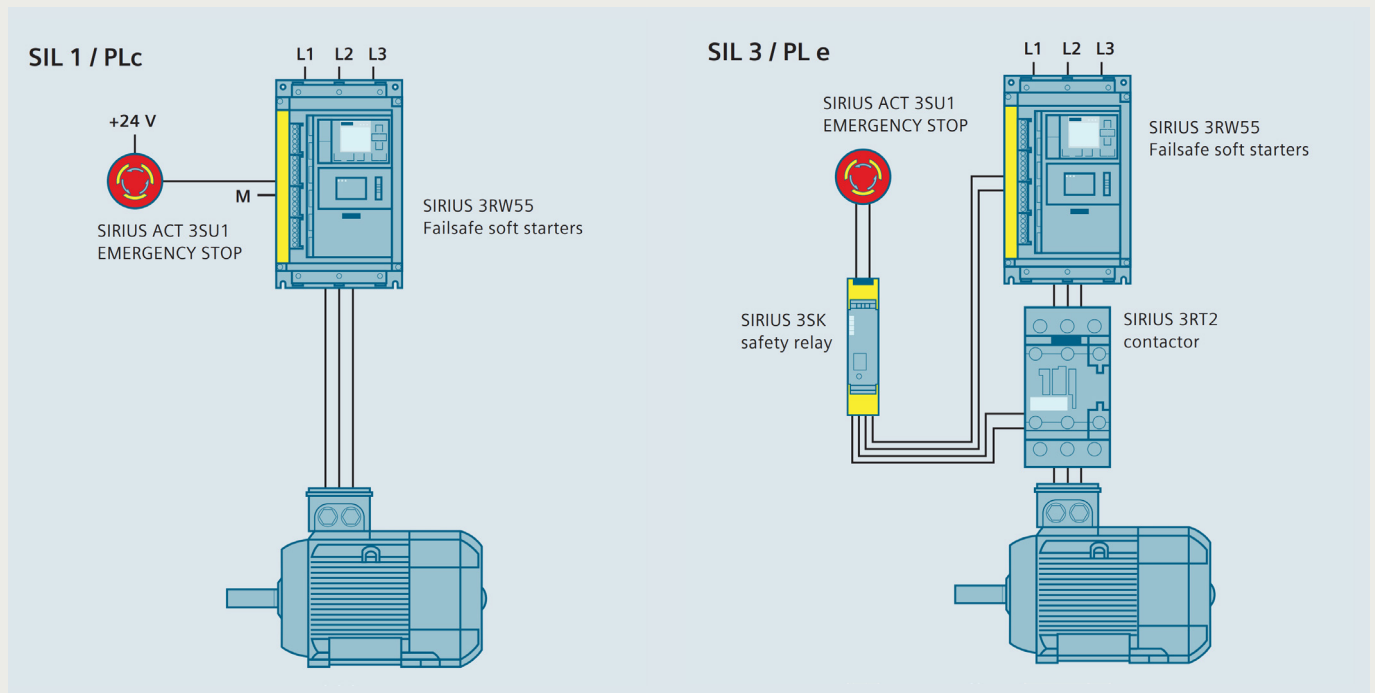

Product characteristics/function	Performance features/benefits
Automatic parameterization	Extremely easy commissioning and reliability even under changing load conditions
Hybrid switching devices and three-phase motor control	Minimum power loss and optimum/symmetrical motor control
Integration into TIA Portal – communication modules optional	Efficient configuration and maximum flexibility in automation engineering
Detachable HMI with color display, local interface, slot for micro SD card	Maximum flexibility with regard to user interface and intuitive menu guidance
Pump stop and torque control	Reduced mechanical loading and optimum pump stop control
Certified according to ATEX/IECEX directives	Suitable for the starting of explosion-proof motors
Fail-safe disconnection up to SIL 3/PL e – STO	Reduced costs and space requirements thanks to direct wiring of the EMERGENCY STOP mushroom pushbutton to the soft starter for SIL 1

# Contactor for safety applications

## Power Contactors for Switching Motors - SIRIUS 3RT



1



2



3



4



5

Description:	Fig.	Size	Order number	L Price £	Prod. group
<b>With two removable laterally mounted auxiliary switches (Busbar Control and auxiliary circuit: screw terminal)</b>					
Power contactor, AC-3, 40 A, 18.5 kW / 400 V Coil AC 50/60 Hz and DC 21-33 V x (0.8-1.1), F-PLC input 24 V DC 3-pole size S2 Auxiliary contact 1 NC	1	S2	3RT2035-1SB30	207.46	41B
Power contactor, AC-3, 40 A, 18.5 kW / 400 V Coil AC 50/60 Hz and DC 83-150 V x (0.8-1.1), F-PLC input 24 V DC 3-pole size S2 Auxiliary contact 1 NC	1	S2	3RT2035-1SF30	207.46	41B
Power contactor, AC-3, 40 A, 18.5 kW / 400 V Coil AC 50/60 Hz and DC 175-280 V x (0.8-1.1), F-PLC input 24 V DC 3-pole size S2 Auxiliary contact 1 NC	1	S2	3RT2035-1SP30	207.46	41B
Power contactor, AC-3, 50 A, 22 kW / 400 V Coil AC 50/60 Hz and DC 21-33 V x (0.8-1.1), F-PLC input 24 V DC 3-pole size S2 Auxiliary contact 1 NC	1	S2	3RT2036-1SB30	252.53	41B
Power contactor, AC-3, 50 A, 22 kW / 400 V Coil AC 50/60 Hz and DC 83-150 V x (0.8-1.1), F-PLC input 24 V DC 3-pole size S2 Auxiliary contact 1 NC	1	S2	3RT2036-1SF30	252.53	41B
Power contactor, AC-3, 50 A, 22 kW / 400 V Coil AC 50/60 Hz and DC 175-280 V x (0.8-1.1), F-PLC input 24 V DC 3-pole size S2 Auxiliary contact 1 NC	1	S2	3RT2036-1SP30	252.53	41B
Power contactor, AC-3, 65 A, 30 kW / 400 V Coil AC 50/60 Hz and DC 21-33 V x (0.8-1.1), F-PLC input 24 V DC 3-pole size S2 Auxiliary contact 1 NC	1	S2	3RT2037-1SB30	326.10	41B
Power contactor, AC-3, 65 A, 30 kW / 400 V Coil AC 50/60 Hz and DC 85-150 V x (0.8-1.1), F-PLC input 24 V DC 3-pole size S2 Auxiliary contact 1 NC	1	S2	3RT2037-1SF30	326.10	41B
Power contactor, AC-3, 65 A, 30 kW / 400 V Coil AC 50/60 Hz and DC 175-280 V x (0.8-1.1), F-PLC input 24 V DC 3-pole size S2 Auxiliary contact 1 NC	1	S2	3RT2037-1SP30	326.10	41B
Power contactor, AC-3, 80 A, 37 kW / 400 V Coil AC 50/60 Hz and DC 21-33 V x (0.8-1.1), F-PLC input 24 V DC 3-pole size S2 Auxiliary contact 1 NC	1	S2	3RT2038-1SB30	340.68	41B
Power contactor, AC-3, 80 A, 37 kW / 400 V Coil AC 50/60 Hz and DC 83-150 V x (0.8-1.1), F-PLC input 24 V DC 3-pole size S2 Auxiliary contact 1 NC	1	S2	3RT2038-1SF30	340.68	41B
Power contactor, AC-3, 80 A, 37 kW / 400 V Coil AC 50/60 Hz and DC 175-280 V x (0.8-1.1), F-PLC input 24 V DC 3-pole size S2 Auxiliary contact 1 NC	1	S2	3RT2038-1SP30	340.68	41B
Power contactor, AC-3, 80 A, 37 kW / 400 V Coil AC 50/60 Hz and DC 21-33 V x (0.8-1.1), F-PLC input 24 V DC 3-pole size S3 Auxiliary contact 1 NC	2	S3	3RT2045-1SB30	355.26	41B
Power contactor, AC-3, 80 A, 37 kW / 400 V Coil AC 50/60 Hz and DC 83-150 V x (0.8-1.1), F-PLC input 24 V DC 3-pole size S3 Auxiliary contact 1 NC	2	S3	3RT2045-1SF30	355.26	41B
Power contactor, AC-3, 80 A, 37 kW / 400 V Coil AC 50/60 Hz and DC 175-280 V x (0.8-1.1), F-PLC input 24 V DC 3-pole size S3 Auxiliary contact 1 NC	2	S3	3RT2045-1SP30	355.26	41B
Power contactor, AC-3, 95 A, 45 kW / 400 V Coil AC 50/60 Hz and DC 21-33 V x (0.8-1.1), F-PLC input 24 V DC 3-pole size S3 Auxiliary contact 1 NC	2	S3	3RT2046-1SB30	405.63	41B
Power contactor, AC-3, 95 A, 45 kW / 400 V Coil AC 50/60 Hz and DC 83-150 V x (0.8-1.1), F-PLC input 24 V DC 3-pole size S3 Auxiliary contact 1 NC	2	S3	3RT2046-1SF30	405.63	41B
Power contactor, AC-3, 95 A, 45 kW / 400 V Coil AC 50/60 Hz and DC 175-280 V x (0.8-1.1), F-PLC input 24 V DC 3-pole size S3 Auxiliary contact 1 NC	2	S3	3RT2046-1SP30	405.63	41B
Power contactor, AC-3, 110 A, 55 kW / 400 V Coil AC 50/60 Hz and DC 21-33 V x (0.8-1.1), F-PLC input 24 V DC 3-pole size S3 Auxiliary contact 1 NC	2	S3	3RT2047-1SB30	432.81	41B
Power contactor, AC-3, 110 A, 55 kW / 400 V Coil AC 50/60 Hz and DC 83-150 V x (0.8-1.1), F-PLC input 24 V DC 3-pole size S3 Auxiliary contact 1 NC	2	S3	3RT2047-1SF30	432.81	41B
Power contactor, AC-3, 110 A, 55 kW / 400 V Coil AC 50/60 Hz and DC 175-280 V x (0.8-1.1), F-PLC input 24 V DC 3-pole size S3 Auxiliary contact 1 NC	2	S3	3RT2047-1SP30	432.81	41B
Power contactor, AC-3 115 A, 55 kW / 400 V Coil AC 50/60 Hz and DC 96-127 V x (0.8-1.1) F-PLC input 24 V DC 3-pole size S6 Auxiliary contacts 2 NO + 2 NC	3	S6	3RT1054-6SF36	476.55	41B
Power contactor, AC-3 115 A, 55 kW / 400 V Coil AC 50/60 Hz and DC 200-277 V x (0.8-1.1) F-PLC input 24 V DC 3-pole size S6 Auxiliary contacts 2 NO + 2 NC	3	S6	3RT1054-6SP36	476.55	41B
Power contactor, AC-3 150 A, 75 kW / 400 V Coil AC 50/60 Hz and DC 96-127 V x (0.8-1.1) F-PLC input 24 V DC 3-pole size S6 Auxiliary contacts 2 NO + 2 NC	3	S6	3RT1055-6SF36	562.05	41B
Power contactor, AC-3 150 A, 75 kW / 400 V Coil AC 50/60 Hz and DC 200-277 V x (0.8-1.1) F-PLC input 24 V DC 3-pole size S6 Auxiliary contacts 2 NO + 2 NC	3	S6	3RT1055-6SP36	562.05	41B
Power contactor, AC-3 185 A, 90 kW / 400 V Coil AC 50/60 Hz and DC 96-127 V x (0.8-1.1) F-PLC input 24 V DC 3-pole size S6 Auxiliary contacts 2 NO + 2 NC	3	S6	3RT1056-6SF36	676.06	41B
Power contactor, AC-3 185 A, 90 kW / 400 V Coil AC 50/60 Hz and DC 200-277 V x (0.8-1.1) F-PLC input 24 V DC 3-pole size S6 Auxiliary contacts 2 NO + 2 NC	3	S6	3RT1056-6SP36	676.06	41B
Power contactor, AC-3 225 A, 110 kW / 400 V Coil AC 50/60 Hz and DC 96-127 V x (0.8-1.1) F-PLC input 24 V DC 3-pole size S10 Auxiliary contacts 2 NO + 2 NC	4	S10	3RT1064-6SF36	775.48	41B
Power contactor, AC-3 225 A, 110 kW / 400 V Coil AC 50/60 Hz and DC 200-277 V x (0.8-1.1) F-PLC input 24 V DC 3-pole size S10 Auxiliary contacts 2 NO + 2 NC	4	S10	3RT1064-6SP36	775.48	41B
Power contactor, AC-3 265 A, 132 kW / 400 V Coil AC 50/60 Hz and DC 96-127 V x (0.8-1.1) F-PLC input 24 V DC 3-pole size S10 Auxiliary contacts 2 NO + 2 NC	4	S10	3RT1065-6SF36	1033.97	41B
Power contactor, AC-3 265 A, 132 kW / 400 V Coil AC 50/60 Hz and DC 200-277 V x (0.8-1.1) F-PLC input 24 V DC 3-pole size S10 Auxiliary contacts 2 NO + 2 NC	4	S10	3RT1065-6SP36	1033.97	41B
Power contactor, AC-3 300 A, 160 kW / 400 V Coil AC 50/60 Hz and DC 96-127 V x (0.8-1.1) F-PLC input 24 V DC 3-pole size S10 Auxiliary contacts 2 NO + 2 NC	4	S10	3RT1066-6SF36	1246.06	41B
Power contactor, AC-3 300 A, 160 kW / 400 V Coil AC 50/60 Hz and DC 200-277 V x (0.8-1.1) F-PLC input 24 V DC 3-pole size S10 Auxiliary contacts 2 NO + 2 NC	4	S10	3RT1066-6SP36	1246.06	41B
Power contactor, AC-3 400 A, 200 kW / 400 V Coil AC 50/60 Hz and DC 96-127 V x (0.8-1.1) F-PLC input 24 V DC 3-pole size S12 Auxiliary contacts 2 NO + 2 NC	5	S12	3RT1075-6SF36	1623.86	41B
Power contactor, AC-3 400 A, 200 kW / 400 V Coil AC 50/60 Hz and DC 200-277 V x (0.8-1.1) F-PLC input 24 V DC 3-pole size S12 Auxiliary contacts 2 NO + 2 NC	5	S12	3RT1075-6SP36	1623.86	41B
Power contactor, AC-3 500 A, 250 kW / 400 V coil AC 50/60 Hz and DC 96-127 V x (0.8-1.1) F-PLC input 24 V DC 3-pole size S12 auxiliary contacts 2 NO + 2 NC	5	S12	3RT1076-6SF36	2253.52	41B
Power contactor, AC-3 500 A, 250 kW / 400 V coil AC 50/60 Hz and DC 200-277 V x (0.8-1.1) F-PLC input 24 V DC 3-pole size S12 auxiliary contacts 2 NO + 2 NC	5	S12	3RT1076-6SP36	2253.52	41B

\* For all standard low-voltage equipment please refer to our SIRIUS Shortform catalogue 2022.

# Contactor for safety applications

## Power Contactors for Switching Motors - SIRIUS 3RT

The world's first contactor with maximum benefits in safety applications

The size S2 to S12 range of tried and tested contactors from 18.5 to 250 kW (AC-3, 400 V) has been expanded to include versions suitable for direct control from fail-safe controllers, rendering the coupling level redundant. The new contactors are also available with non-removable, lateral auxiliary switches, enabling fulfilment of Swiss Accident Insurance Institute (SUVA) requirements.

The new contactors constitute the logical extension and further development of the SIRIUS modular system, serving to promote safe switching. They are the first contactors on the market to be equipped with an input for fail-safe signals. This makes it possible to attain SIL 2 and/or PL c with just one contactor and SIL 3 and/or PL e with two contactors in series according to IEC 62061 and ISO 13849-1.

The big advantage of this solution is that it saves on additional, possibly positively-driven coupling relays and makes evaluation of safety information considerably easier.

This reduction in coupling relays is also a huge plus point for non-safety applications. Whereas previously space, money and wiring expertise were required in order to operate contactors from 55 kW and higher using controllers, both functional and safety switching can now take place by direct activation.

Using the Safety Evaluation Tool you can quickly find the right contactor and safely configure your application.

### Example for SIL 2 and SIL 3 / PL e application – previously:

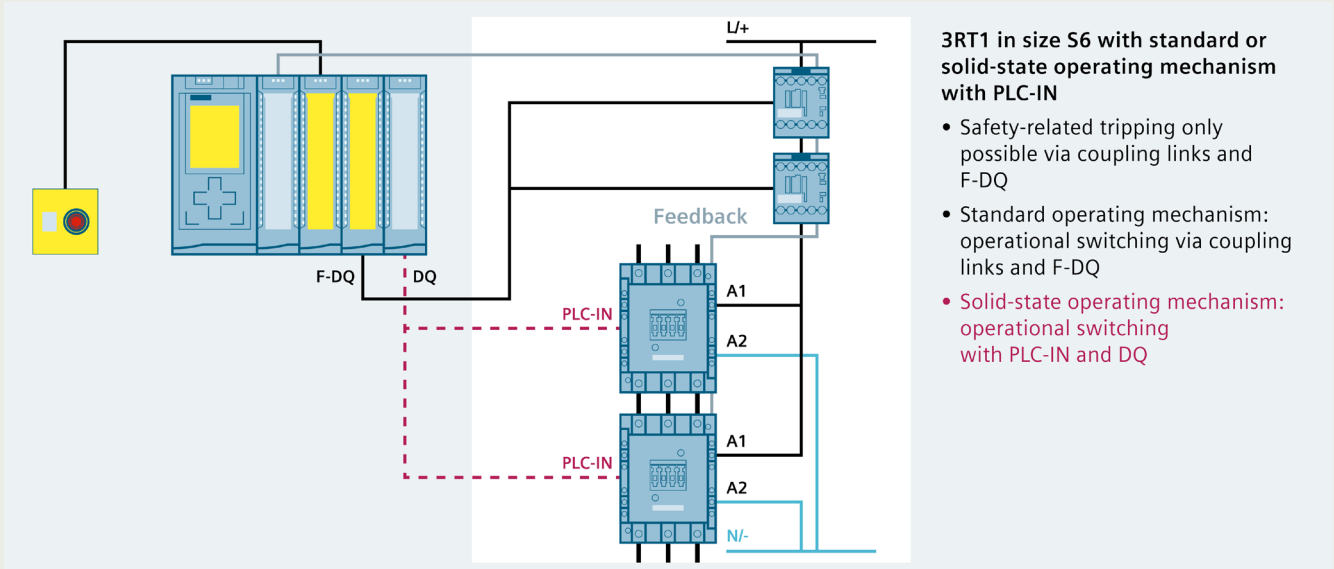

### Example for SIL 3 / PL e (left) and SIL 2 / PL c (right) application – new:

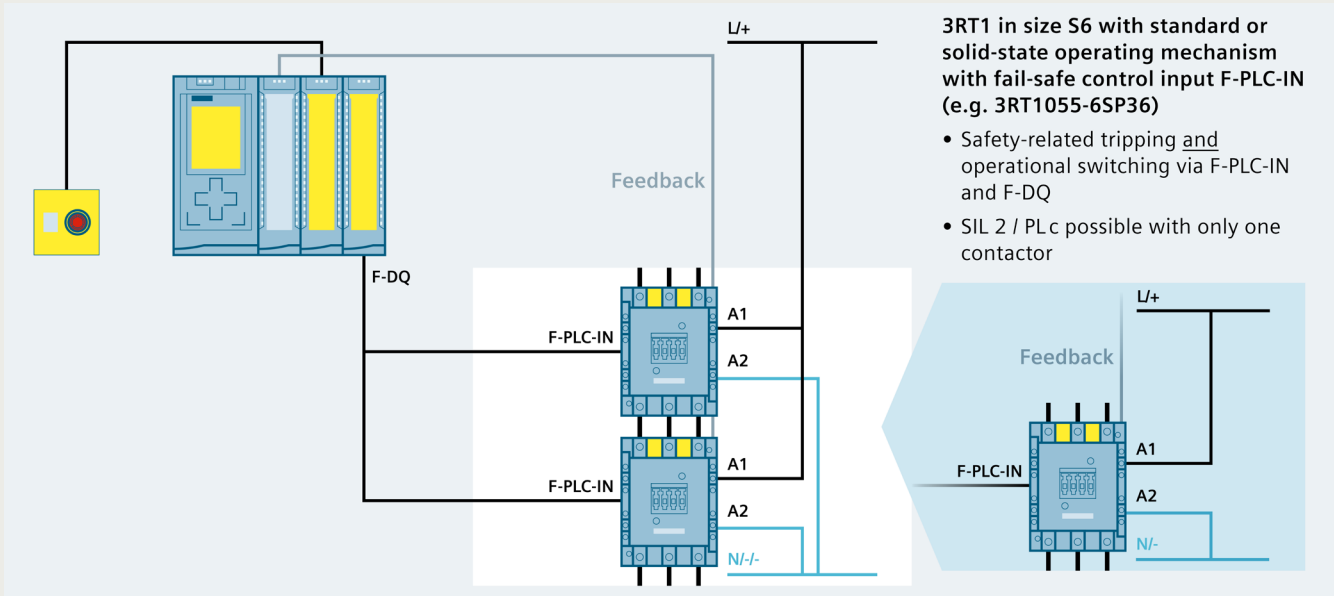



# Position switches and safety position switches

## Safety relays - SIRIUS 3SE5\*

All Siemens position and safety position switches are suitable for both standard applications and machine safety applications (all contact elements have mechanically driven break contacts to IEC 60947-51)



Description:	Fig.	Order number	L Price £	Prod. group
<b>Plastic position switch (EN 50047), IP65, enclosure 31mm wide, 1xM20 cable entry, 1NO+1NC snap-action contact, 10A (AC15):</b>				
Teflon plunger (basic switch), type B to EN 50047	1	3SE5232-0CC05	15.48	41K
Plastic plunger, with plastic roller 10mm, type C to EN 50047 <sup>1</sup>	2	3SE5232-0HD03	19.65	41K
Plastic roller lever, with 13mm plastic roller, type E to EN 50047 <sup>1</sup>	3	3SE5232-0HE10	22.54	41K
90° plastic roller lever, with 13mm plastic roller, sideways operation <sup>1</sup>	4	3SE5232-0HF10	22.54	41K
Plastic twist lever, with 19mm plastic roller, type A to EN 50047 <sup>1</sup>	5	3SE5232-0HK21	23.22	41K
Plastic twist lever, with 19mm plastic roller, adjustable length <sup>1</sup>	6	3SE5232-0HK60	28.50	41K
Plastic actuator rod, adjustable length <sup>1</sup>	7	3SE5232-0HK82	29.24	41K
Aluminium actuator rod, adjustable length <sup>1</sup>	7	3SE5232-0HK80	28.13	41K
Spring lever with plastic top <sup>1</sup>	8	3SE5232-0HR01	28.93	41K
<b>Plastic position switch (EN 50047), IP65, enclosure 31mm wide, 1xM20 cable entry, 1NO+2NC snap-action contact, 6A (AC15):</b>				
Teflon plunger (basic switch), type B to EN 50047	1	3SE5232-0LC05	17.75	41K
Plastic plunger, with 10mm plastic roller, type C to EN 50047	2	3SE5232-0LD03	21.25	41K
Plastic roller lever, with 13mm plastic roller, type E to EN 50047	3	3SE5232-0LE10	23.95	41K
90° plastic roller lever, with 13mm plastic roller, sideways operation	4	3SE5232-0LF10	23.95	41K
Plastic twist lever, with 19mm plastic roller, type A to EN 50047	5	3SE5232-0LK21	24.75	41K
<b>Plastic position switch (EN 50047), IP65, enclosure 50mm wide, 2xM20 cable entry, 1NO+2NC snap-action contact, 6A (AC15):</b>				
Teflon plunger (basic switch)	9	3SE5242-0LC05	20.07	41K
Plastic plunger, with 10mm plastic roller	10	3SE5242-0LD03	25.37	41K
Plastic roller lever, with 13mm plastic roller	11	3SE5242-0LE10	28.19	41K
Plastic twist lever, with 19mm plastic roller	12	3SE5242-0LK21	28.93	41K
<b>Metal position switch (EN 50047), IP67, enclosure 31mm wide, 1xM20 cable entry, 1NO+1NC snap-action contact, 10A (AC15):</b>				
Teflon plunger (basic switch), type B to EN 50047	13	3SE5212-0CC05	21.13	41K
Stainless steel plunger	13	3SE5212-0CB01	26.78	41K
Plastic plunger, with 10mm plastic roller, type C to EN 50047	14	3SE5212-0CD03	25.43	41K
Plastic roller lever, with 13mm plastic roller, type E to EN 50047	15	3SE5212-0CE10	27.33	41K
90° plastic roller lever, with 13mm plastic roller, sideways operation	16	3SE5212-0CF10	27.33	41K
Plastic twist lever, with 19mm plastic roller, type A to EN 50047	17	3SE5212-0CK21	28.99	41K
Plastic twist lever, with 19mm plastic roller, adjustable length	18	3SE5212-0CK60	34.27	41K
<b>Metal position switch (EN 50047), IP67, enclosure 31mm wide, 1xM20 cable entry, 1NO+2NC snap-action contact, 6A (AC15):</b>				
Teflon plunger (basic switch), type B to EN 50047	13	3SE5212-0LC05	23.46	41K
Stainless steel plunger	13	3SE5212-0LB01	28.19	41K
Plastic plunger, with 10mm plastic roller, type C to EN 50047	14	3SE5212-0LD03	27.76	41K
Plastic roller lever, with 13mm plastic roller, type E to EN 50047	15	3SE5212-0LE10	29.67	41K
90° plastic roller lever, with 13mm plastic roller, sideways operation	16	3SE5212-0LF10	29.67	41K
Plastic twist lever, with 19mm plastic roller, type A to EN 50047	17	3SE5212-0LK21	31.39	41K
Plastic twist lever, with 19mm plastic roller, adjustable length	18	3SE5212-0LK60	36.48	41K

1) contact block not replaceable

Special designs of position switches to EN 50047 model:

- Extra corrosion-resistant designs: see IC 10 2021 catalogue
- Plastic enclosure: see IC 10 2021 catalogue
- Models for extremely low ambient temperatures (-40 °C): see IC 10 2021 catalogue
- ATEX models for use in explosive environments: see IC 10 2021 catalogue
- Position switches with integrated AS interface coupling: see IC 10 2021 catalogue

\*For more models and comprehensive technical information, please see the Industrial Controls catalogue: IC 10 2021. For the latest information, visit the Industry Mall: [www.siemens.com/industrymall/gb](http://www.siemens.com/industrymall/gb)

# Position switches and safety position switches



Description:	Fig.	Order number	L Price £	Prod. group
<b>Metal position switch (EN 50041), IP67, enclosure 40mm wide, 1xM20 cable entry, 1NO+1NC snap-action contact, 10A (AC15):</b>				
Teflon plunger (basic switch)	1	3SE5112-0CA00	23.95	41K
Metal plunger, type B to EN 50041	2	3SE5112-0CC02	39.31	41K
Metal plunger, with 13mm plastic roller, type C to EN 50041	3	3SE5112-0CD02	43.79	41K
Metal roller lever, with 22mm plastic roller	4	3SE5112-0CE01	37.59	41K
90° metal roller lever, with 22mm plastic roller, sideways operation	5	3SE5112-0CF01	37.59	41K
Metal twist lever, with 19mm plastic roller, type A to EN 50041	6	3SE5112-0CH01	42.20	41K
Metal twist lever, with 19mm plastic roller, adjustable length	7	3SE5112-0CH60	46.56	41K
Plastic actuator rod, adjustable length, type D to EN 50041	8	3SE5112-0CH82	48.64	41K
Aluminium actuator rod, adjustable length, type D to EN 50041	8	3SE5112-0CH80	47.42	41K
Spring lever with plastic top	9	3SE5112-0CR01	37.28	41K
Fork lever actuator with 2 rollers	10	3SE5112-0CT11	70.02	41K
<b>Metal position switch (EN 50041), IP67, enclosure 40mm wide, 1xM20 cable entry, 1NO+2NC snap-action contact, 6A (AC15):</b>				
Teflon plunger (basic switch)	1	3SE5112-0LA00	25.49	41K
Metal plunger, type B to EN 50041	2	3SE5112-0LC02	40.84	41K
Metal plunger, with 13mm plastic roller, type C to EN 50041	3	3SE5112-0LD02	45.14	41K
Metal roller lever, with 22mm plastic roller	4	3SE5112-0LE01	39.00	41K
90° metal roller lever, with 22mm plastic roller, sideways operation	5	3SE5112-0LF01	39.00	41K
Metal twist lever, with 19mm plastic roller, type A to EN 50041	6	3SE5112-0LH01	43.55	41K
<b>Metal position switch (EN 50041), IP67, enclosure 56mm wide, 3xM20 cable entry, 1NO+2NC snap-action contact, 6A (AC15):</b>				
Teflon plunger (basic switch)	11	3SE5122-0LA00	25.37	41K
Metal plunger	12	3SE5122-0LC02	40.84	41K
Metal plunger, with 13mm metal roller	13	3SE5122-0LD02	45.14	41K
Metal roller lever, with 22mm plastic roller	14	3SE5122-0LE01	39.19	41K
Metal twist lever, with 19mm plastic roller	15	3SE5122-0LH01	43.55	41K

## Special designs of position switches to EN 50041 model:

- Extra corrosion-resistant designs: see IC 10 2021 catalogue
- Plastic enclosure: see IC 10 2021 catalogue
- Models for extremely low ambient temperatures (-40 °C): see IC 10 2021 catalogue
- XL enclosure with max. 6 switching contacts: see IC 10 2021 catalogue
- ATEX models for use in explosive environments: see IC 10 2021 catalogue
- Position switches with integrated AS interface coupling: see IC 10 2021 catalogue

## Accessories for 3SE5 position switches\*

























Description:	Fig.	Order number	L Price £	Prod. group
<b>Levers for small standard switches to EN 50047:</b>				
Plunger lever with stainless plunger	1	3SE5000-0AB01	5.63	41K
Plastic plunger lever, with 10mm plastic roller, type C to EN 50047	2	3SE5000-0AD03	4.54	41K
Plastic plunger lever, with 10mm stainless steel roller, type C to EN 50047	2	3SE5000-0AD04	11.55	41K
Metal roller lever, with 13mm plastic roller, type E to EN 50047	3	3SE5000-0AE10	7.27	41K
Stainless steel roller lever, with 13mm stainless steel roller, type E to EN 50047	3	3SE5000-0AE13	17.75	41K
Plastic actuator head, with round spindle, for twist lever type A to EN 50047 (excl. twist lever)	4	3SE5000-0AK00	5.39	41K
Metal twist lever, with 19mm plastic roller, type A to EN 50047	5	3SE5000-0AA21	3.01	41K
Stainless steel twist lever, with stainless steel 19mm roller, type A to EN 50047	5	3SE5000-0AA32	11.98	41K
<b>Levers for large standard switches to EN 50041:</b>				
Metal plunger lever, stainless steel plunger, type B to EN 50041	6	3SE5000-0AC02	15.54	41K
Metal plunger lever, with 13mm stainless steel roller, type C to EN 50041	7	3SE5000-0AD02	19.78	41K
Metal roller lever, with 22mm plastic roller, type E to EN 50041	8	3SE5000-0AE01	13.64	41K
Stainless steel roller lever, with 22mm stainless steel roller, type E to EN 50041	8	3SE5000-0AE04	24.20	41K
Metal actuator head with round spindle, for twist lever type A to EN 50041 (excl. twist lever)	9	3SE5000-0AH00	14.37	41K
Metal twist lever, with 22mm plastic roller, type A to EN 50041	10	3SE5000-0AA01	3.82	41K
Stainless steel twist lever, with stainless steel 22mm roller, type A to EN 50041	10	3SE5000-0AA12	12.78	41K
<b>Other levers/accessories:</b>				
Metal twist lever, with 22mm plastic roller, adjustable length	11	3SE5000-0AA50	6.33	41K
Stainless steel twist lever, with 22mm stainless steel roller, adjustable length	11	3SE5000-0AA53	15.23	41K
Spring lever with plastic top	12	3SE5000-0AR01	13.45	41K
Spring lever with stainless steel top	12	3SE5000-0AR02	20.82	41K
Aluminium actuator rod, adjustable length	13	3SE5000-0AA80	7.80	41K
Plastic actuator rod, adjustable length	13	3SE5000-0AA82	8.91	41K
Contact block 1NO +1NC, slide contacts	14	3SE5000-0BA00	13.02	41K
Contact block 1 NO +1NC, snap-action contacts	14	3SE5000-0CA00	12.16	41K
Contact block 1 NO +2NC, slide contacts	15	3SE5000-0KA00	14.56	41K
Contact block 1 NO +2NC, snap-action contacts	15	3SE5000-0LA00	13.70	41K
LED cover, electric blue colour, plastic, for position switch 31mm wide (EN 50047), 24 VDC	16	3SE5230-1AA00	16.52	41K
LED cover, yellow colour, plastic, for safety position switch 31mm wide (EN 50047), 24 VDC		3SE5230-0AAA00-1AG0	2.41	41K
LED cover, yellow colour, plastic, for safety position switch 31mm wide (EN 50047), 24 VDC		3SE5230-1AA00-1AG0	16.52	41K
LED cover, electric blue colour, metal, for position switch 40mm wide (EN 50041), 24 VDC		3SE5110-1AA00	17.26	41K
LED cover, yellow colour, metal, for safety position switch 40mm wide (EN 50041), 24 VDC		3SE5110-0AAA00-1AG0	3.25	41K
LED cover, yellow colour, metal, for safety position switch 40mm wide (EN 50041), 24 VDC	17	3SE5110-1AA00-1AG0	17.26	41K



\*For more models and comprehensive technical information, please see the Industrial Controls catalogue: IC 10 2021. For the latest information, visit the Industry Mall: [www.siemens.com/industrymall/gb](http://www.siemens.com/industrymall/gb)

# Position switches and safety position switches

## Position switches with moulded cables - SIRIUS 3SE5\*

Description:		Fig.	Order number	L Price £	Prod. group
<b>Metal position switch IP67, enclosure 30mm wide, 1NO+1NC snap-action contact, 10A (AC15):</b>					
	Metal plunger, 2m moulded cable (5x0.75mm <sup>2</sup> ), with side cable exit	1	3SE5413-OCC20-1EA2	37.28	41K
	Metal plunger, 5m moulded cable (5x0.75mm <sup>2</sup> ), with side cable exit	1	3SE5413-OCC20-1EA5	47.17	41K
	Metal plunger, M12 plug connector on side of enclosure	2	3SE5413-OCC20-1EB1	39.98	41K
	Metal plunger with central fixing (M12), 2m moulded cable (5x0.75mm <sup>2</sup> ), with side cable exit	3	3SE5413-OCC21-1EA2	41.89	41K
	Metal plunger with rubber seal, 2m moulded cable (5x0.75mm <sup>2</sup> ), with side cable exit	4	3SE5413-OCC22-1EA2	41.89	41K
	Plunger with roller, 2m moulded cable with side cable exit	5	3SE5413-OCD20-1EA2	39.12	41K
	Plunger with roller, 5m moulded cable with side cable exit	5	3SE5413-OCD20-1EA5	49.14	41K
	Plunger with roller, M12 plug connector on side of enclosure	6	3SE5413-OCD20-1EB1	41.89	41K
	Plunger with roller and central fixing (M12), 2m moulded cable (5x0.75mm <sup>2</sup> ), with side cable exit	7	3SE5413-OCD21-1EA2	49.87	41K
	Plunger with roller twisted 90°, 2m moulded cable with side cable exit	8	3SE5413-OCD23-1EA2	39.12	41K
	Twist lever with roller, 2m moulded cable with side cable exit	9	3SE5413-OCN20-1EA2	40.97	41K
	Twist lever with roller, 5m moulded cable with side cable exit	9	3SE5413-OCN20-1EA5	50.92	41K
	Twist lever with roller, M12 plug connector on side of enclosure	10	3SE5413-OCN20-1EB1	43.61	41K
	<b>Metal position switch, IP67, enclosure 40mm wide, 1NO+1NC snap-action contact, 10A (AC15):</b>				
	Metal plunger, 2m moulded cable (5x0.75mm <sup>2</sup> ), with bottom cable exit	11	3SE5423-OCC20-1EA2	45.51	41K
	Metal plunger, M12 plug connector on bottom of enclosure	12	3SE5423-OCC20-1EB1	48.28	41K
	Metal plunger with central fixing (M12), 2m moulded cable (5x0.75mm <sup>2</sup> ), with bottom cable exit	13	3SE5423-OCC21-1EA2	51.84	41K
	Metal plunger with rubber seal, 2m moulded cable (5x0.75mm <sup>2</sup> ), with bottom cable exit	14	3SE5423-OCC22-1EA2	49.87	41K
	Plunger with roller, 2m moulded cable with bottom cable exit	15	3SE5423-OCD20-1EA2	47.23	41K
	Plunger with roller, M12 plug connector on bottom of enclosure	16	3SE5423-OCD20-1EB1	48.28	41K
	Plunger with roller and central fixing (M12), 2m moulded cable (5x0.75mm <sup>2</sup> ), with bottom cable exit		3SE5423-OCD21-1EA2	58.23	41K
	Twist lever with roller, 2m moulded cable with bottom cable exit	17	3SE5423-OCN20-1EA2	49.20	41K
	Twist lever with roller, M12 plug connector on bottom of enclosure	18	3SE5423-OCN20-1EB1	51.90	41K

## Position switches without enclosure - SIRIUS 3SE5\*

Description:		Fig.	Order number	L Price £	Prod. group
<b>Position switches without enclosure, plastic, IP20 / IP10, 30mm wide, with Teflon operating plunger, 6A (AC15):</b>					
	1NO+1NC, slide contacts, IP20	1	3SE5250-OBC05	17.14	41K
	1NO+1NC, snap-action contacts, IP20	1	3SE5250-OCC05	16.15	41K
	1NO+2NC, slide contacts, IP20	2	3SE5250-OKC05	17.20	41K
	1NO+2NC, snap-action contacts, IP20	2	3SE5250-OLC05	17.01	41K

\*For more models and comprehensive technical information, please see the Industrial Controls catalogue: IC 10 2021 For the latest information, visit the Industry Mall: [www.siemens.com/industrymall/gb](http://www.siemens.com/industrymall/gb)

# Gate locking switches

## Gate locking switches - SIRIUS 3SE5\*

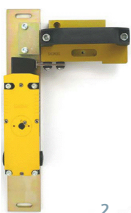

Description:	Fig.	Order number	L Price £	Prod. group
<b>Plastic gate monitoring switch with locking function, IP66/IP67, enclosure 54mm wide, 3xM20 cable entry, 24 V DC, 1NO+2NC / 1NO+2NC 6A (AC15):</b>				
Spring locked, 1300N, with auxiliary release	1	3SE5322-0SD21	171.98	41K
Spring locked, 1300N, auxiliary release with lock	2	3SE5322-0SE21	200.84	41K
Spring locked, 1300N, escape release from front	3	3SE5322-0SF21	213.74	41K
Spring locked, 1300N, escape release from back and auxiliary release from front	4	3SE5322-0SG21	240.15	41K
Magnetically locked, 1300N, with auxiliary release	1	3SE5322-0SB21	175.66	41K
<b>Metal gate monitoring switch with locking function, IP66/IP67, enclosure 54mm wide, 3xM20 cable entry, 24 V DC, 1NO+2NC / 1NO+2NC 6A (AC15):</b>				
Spring locked, 2600N, with auxiliary release	1	3SE5312-0SD11	225.41	41K
Spring locked, 2600N, auxiliary release with lock	2	3SE5312-0SE11	253.05	41K
Spring locked, 2600N, escape release from front	3	3SE5312-0SF11	265.95	41K
Spring locked, 2600N, escape release from back and auxiliary release from front	4	3SE5312-0SG11	292.97	41K
Magnetically locked, 2600N, with auxiliary release	1	3SE5312-0SB11	232.17	41K
<b>Accessories for 3SE5 position switches:</b>				
Actuator straight (for gate monitoring switch)	5	3SE5000-0AV01	4.70	41K
Actuator 90°, vertical (for gate monitoring switch)	6	3SE5000-0AV02	5.38	41K
Actuator 90°, horizontal (for gate monitoring switch)	7	3SE5000-0AV03	5.38	41K
Universal radius actuator (for gate monitoring switch)	8	3SE5000-0AV05	24.65	41K
Universal radius actuator (for gate monitoring switch)	9	3SE5000-0AV07	53.40	41K

Description:	Fig.	Order number	L Price £	Prod. group
<b>Mechanical gate locks: (accompanying SIRIUS 3SE5312/-322 gate locking switch to be ordered separately)</b>				
AXELENT X-lock, for doors with lock on the left, suitable for revolving and sliding doors		L66-20L	*	
AXELENT X-lock, for doors with lock on the right, suitable for revolving and sliding doors	1	L66-20R	*	

\* AXELENT door locks can be ordered direct from:

**AXELENT GmbH, Sigmaringer Strasse 122, 70567 Stuttgart-Möhringer, Germany**

Tel.: 0049 711 2525090, Fax: 0049 711 25250949, E-mail: [sales@axelent.de](mailto:sales@axelent.de), internet: [www.axelent.de](http://www.axelent.de)

Inga Tools, suitable for doors with lock on the left or right, for revolving and sliding doors	2	I-SIE-0004-07-R	**	
--	---	-----------------	----	--

\*\* Inga Tools door locks can be ordered direct from:

**Inga Tools GmbH, Neckarstrasse 10, 38120 Braunschweig, Germany**

Tel.: 0049 531 390440, Fax: 0049 531 3904429, internet: [www.ingatools.de](http://www.ingatools.de)

# Gate monitoring & Cable-operated switches

## Gate monitoring switches - SIRIUS 3SE5\*



Description:	Fig.	Order number	L Price £	Prod. group
<b>Gate monitoring switch (EN 50047), IP65, enclosure 31mm wide, 1xM20 cable entry, 1NO+2NC slide contact, 6A (AC15):</b>				
Plastic enclosure, gate monitoring switch with separate actuator	1	3SE5232-0QV40	34.58	41K
Plastic enclosure, gate monitoring switch with separate actuator, increased extraction force 30N	1	3SE5232-0QV40-1AA1	36.36	41K
Metal enclosure, gate monitoring switch with separate actuator	1	3SE5212-0QV40	41.27	41K
<b>Gate monitoring switch (EN 50041), IP67 enclosure 40mm wide, 1xM20 cable entry, 1NO+2NC slide contact, 6A (AC15):</b>				
Plastic enclosure, gate monitoring switch with separate actuator	2	3SE5132-0QV20	37.53	41K
Metal enclosure, gate monitoring switch with separate actuator	2	3SE5112-0QV10	60.31	41K
Metal enclosure, gate monitoring switch with separate actuator, increased extraction force 30N	2	3SE5112-0QV10-1AA7	63.88	41K
<b>Accessories for 3SE5 position switches:</b>				
Actuator straight (for gate monitoring switch)	3	3SE5000-0AV01	4.70	41K
Actuator 90°, vertical (for gate monitoring switch)	4	3SE5000-0AV02	5.38	41K
Actuator 90°, horizontal (for gate monitoring switch)	5	3SE5000-0AV03	5.38	41K
Universal radius actuator (for gate monitoring switch)	6	3SE5000-0AV05	24.65	41K
Universal radius actuator (for gate monitoring switch)	7	3SE5000-0AV07	53.40	41K
<b>Plastic gate monitoring switch 3SE2243, IP67 enclosure 52mm wide, 3xM20 cable entry, 1NO+2NC slide contact, 6A (AC15):</b>				
Gate monitoring switch with separate actuator, extraction force 5N	8	3SE2243-0XX40	32.49	41K
Gate monitoring switch with separate actuator, extraction force 30N	8	3SE2243-0XX	33.84	41K
Gate monitoring switch with separate actuator, with automatic actuator ejection	8	3SE2243-0XX30	33.84	41K
<b>Accessories for 3SE2243 gate monitoring switches:</b>				
Actuator straight (for gate monitoring switch)	9	3SX3218	3.74	41K
Universal radius actuator (for gate monitoring switch)	10	3SX3228	8.84	41K

## Cable-operated switches - SIRIUS 3SE7\*



Description:	Fig.	Order number	L Price £	Prod. group
<b>Metal cable-operated switch IP65/IP67, 1xM20 cable entry, snap-action contact, 6A (AC15):</b>				
Cable length max. 10m, with release function, 1NO+2NC, enclosure with yellow cover	1	3SE7120-1BH00	157.24	41K
Cable length max. 25m, with release function, 1NO+1NC	2	3SE7150-1BD00	143.11	41K
Cable length max. 25m, with release function, 1NO+2NC, enclosure with yellow covert	1	3SE7150-1BH00	157.24	41K
Cable length max. 50m, with release function, 1NO+1NC	3	3SE7140-1BD00	332.90	41K
Cable length max. 50m, with release function, 2NC	3	3SE7140-1BF00	332.90	41K
Cable length max. 75m, with release function and emergency-stop button, 1NO+3NC	4	3SE7141-1EG10	286.22	41K
Cable length max. 2x75m, with release function, 2NO+2NC	5	3SE7160-1AE00	355.01	41K
<b>Accessories for cable-operated switches:</b>				
Steel cable with red plastic sleeve, 4mm diameter, length 10m.	6	3SE7910-3AA	49.20	41K
Steel cable with red plastic sleeve, 4mm diameter, length 20m.	6	3SE7910-3AC	97.66	41K
Steel cable with red plastic sleeve, 4mm diameter, length 50m.	6	3SE7910-3AH	243.84	41K
Cable clamp (duplex), suitable for 4mm cable (min. order 4 pcs)	7	3SE7941-1AC	8.91	41K
Pretensioning spring 35N (max.cable length 2x50m)	8	3SE7931-1AD	21.13	41K
Pretensioning spring 35N (max. cable length 2x75m)	8	3SE7931-1AE	24.02	41K
Turnbuckle, M6x60	9	3SE7950-1AB	10.38	41K
Cable pulley, suitable for 4mm cable	10	3SE7921-1AC	11.55	41K
Cable mount (U shape), incl. nuts	11	3SE7921-1AA	2.74	41K
Cable mount (eye bolt), M8, incl. nut	12	3SE7920-1AB	7.00	41K
Cable mount (eye bolt), M6, incl. 2 nuts	13	3SE7922-1AB	7.12	41K
Thimble, suitable for 4mm cable (min. order 4 pcs)	14	3SE7930-1AD	1.66	41K
Snap hook, 50mm x 5mm packaging as set (2 units)	15	3SE7932-1AC	17.20	41K

\*For more models and comprehensive technical information, please see the Industrial Controls catalogue: IC 10 2021. For the latest information, visit the Industry Mall: [www.siemens.com/industrymall/gb](http://www.siemens.com/industrymall/gb)



# Cable-operated assembly instructions

## Cable pretensions and operating forces

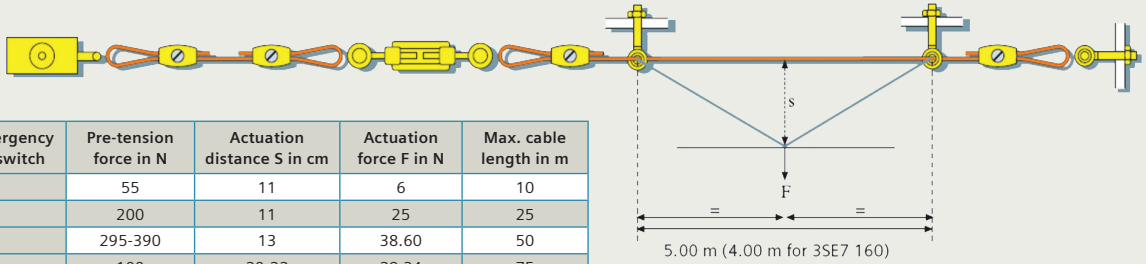

Cable tension Emergency SWITCHING-OFF switch	Pre-tension force in N	Actuation distance S in cm	Actuation force F in N	Max. cable length in m
3SE7 120-1BF00	55	11	6	10
3SE7 150	200	11	25	25
3SE7 140	295-390	13	38.60	50
3SE7 141	100	20-22	28.34	75
3SE7 160	-	32-40	45.85	2x75

## Cable lengths up to 25m

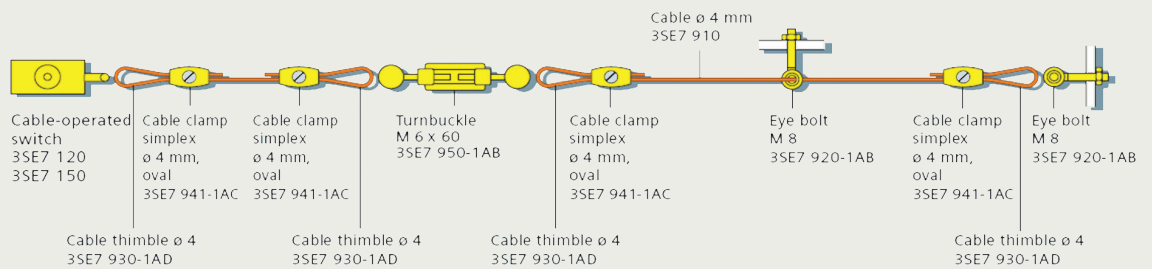

## Cable lengths up to 50m

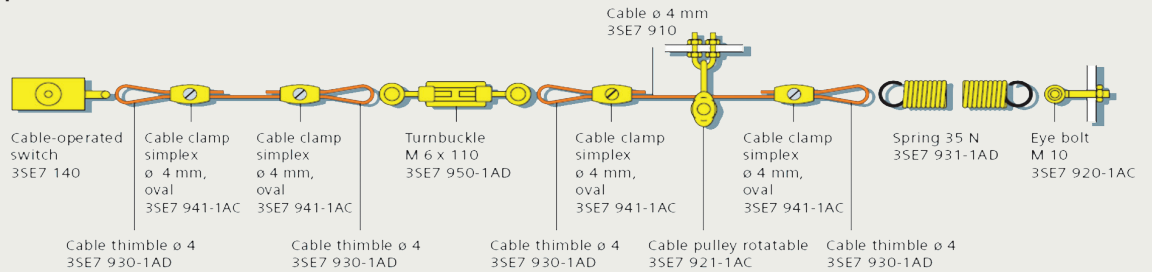

## Cable lengths up to 2x75m

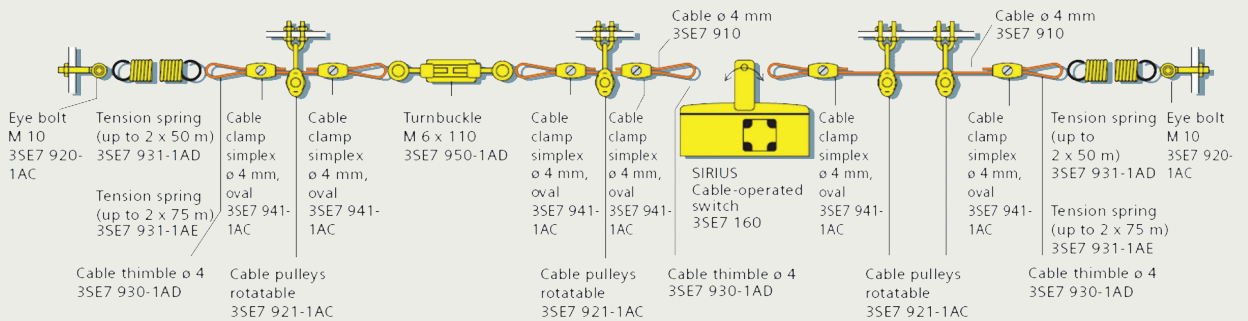

# Hinge Switches

## Hinge switches - SIRIUS 3SE5\*



Description:	Fig.	Order number	L Price £	Prod. group
<b>Plastic hinge switch, IP65, enclosure 31 mm wide (EN 50047) 1xM20 cable entry, 1NO+2NC snap-action contact, 6A (AC15):</b>				
Hinge switch, hollow pin, opening angle 10°		3SE5232-0LU21	32.37	41K
Hinge switch, solid pin, opening angle 10°	1	3SE5232-0LU22	32.37	41K
<b>Metal hinge switch, IP67, enclosure 40mm wide (EN 50041), 1xM20 cable entry, 1NO+2NC snap-action contact, 6A (AC15):</b>				
Hinge switch, hollow pin, opening angle 10°	2	3SE5112-0LU21	40.84	41K
Hinge switch, solid pin, opening angle 10°		3SE5112-0LU22	47.29	41K
<b>Plastic hinge switch integrated into aluminium hinge, IP65 2xM20 cable entry, 1NO+2NC slide contact, 2A (AC15):</b>				
Hinge switch, hollow pin, opening angle 4°. Supply includes 2nd hinge and fasteners	3	3SE2283-0GA43	146.18	41K

## Foot switches - SIRIUS 3SE29\*

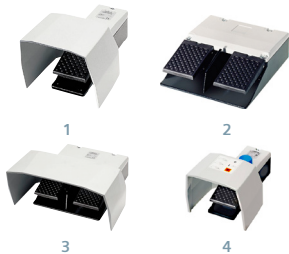

Description:	Fig.	Order number	L Price £	Prod. group
<b>Metal foot switch IP65, 1xM20 cable entry, 2NO+2NO slide contacts, 6A (AC15):</b>				
1 pedal, switching, without protective cover		3SE2903-1AB20	91.52	41K
1 pedal, switching, with protective cover	1	3SE2903-1AA20	135.12	41K
2 pedals, switching, without protective cover	2	3SE2932-1AB20	156.01	41K
2 pedals, switching, with protective cover	3	3SE2932-1AA20	219.88	41K
Safety foot switch to ISO 13850, 1 pedal, switching (NO) and latching (NC), with protective cover	4	3SE2924-3AA20	223.57	41K

## Two-hand operation consoles - SIRIUS 3SU1\*



Description:	Fig.	Order number	L Price £	Prod. group
<b>Two-hand operation consoles, 3 x pushbutton black with 1NO+1NC, emergency-stop button 40mm turn-to-release with 2NC IP65:</b>				
Metal enclosure	1	3SU1853-3NB00-1AA1	434.82	41J
Plastic enclosure	1	3SU1803-3NB00-1AE1	230.05	41J
<b>Accessories for two-hand operation consoles:</b>				
Stand for two-hand operation console	2	3SU1950-0HN10-0AA0	437.98	41J

## Signalling columns - SIRIUS 8WD

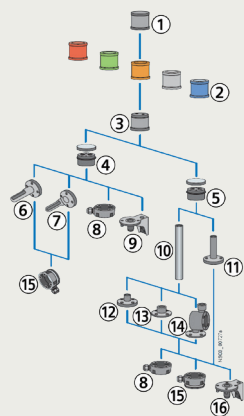

- 1 Acoustic element **8WD44**
- 2 Light element **8WD44**
- 3 AS-Interface adapter element **8WD4428-0BD/8WD4428-0BE**
- 4 Connection element for bracket, base and floor mounting **8WD4408-0AB/8WD4408-0AE**
- 5 Connection element for pipe mounting **8WD4408-0AA/8WD4408-0AD**
- 6 Bracket for wall mounting **8WD4308-0CA**
- 7 Bracket for wall mounting (two-side) **8WD4308-0CB**
- 8 Connection for socket **8WD4308-0DD**
- 9 Bracket for base mounting **8WD4408-0CD**
- 10 Pipe **8WD42/8WD43**
- 11 Foot with pipe **8WD4308-0DA**
- 12 Foot with pipe mounting **8WD4308-0DB**
- 13 Foot for pipe mounting (>400 mm) **8WD4308-0DC**
- 14 Foldaway foot for pipe mounting **8WD4408-0DF**
- 15 Connection socket (magnetic mounting) **8WD4308-0DE**
- 16 Bracket for foot mounting **8WD4408-0CC**

\*For more models and comprehensive technical information, please see the Industrial Controls catalogue: IC 10 2021. For the latest information, visit the Industry Mall: [www.siemens.com/industrymall/gb](http://www.siemens.com/industrymall/gb)

# Signalling Columns

## Signalling columns - SIRIUS 8WD\*

Signalling columns, small design (50mm diameter): see catalogue: IC 10 2018 catalogue



Description:	Fig.	Order number	L Price £	Prod. group
<b>Signalling unit, optical, plastic, diameter 70mm, IP 65, max. 5 elements, screw terminal, integrated LED, steady, 24 V AC / DC:</b>				
Signalling element, steady, red	1	8WD4420-5AB	60.87	41J
Signalling element, steady, green	2	8WD4420-5AC	60.87	41J
Signalling element, steady, orange	3	8WD4420-5AD	60.87	41J
Signalling element, steady, clear	4	8WD4420-5AE	65.11	41J
Signalling element, steady, blue	5	8WD4420-5AF	65.11	41J
<b>Signalling element, optical, plastic, diameter 70mm, IP 65, max. 5 units, screw terminal, BA15d lamp socket, 12-230 VAC / DC:</b>				
Signalling element, red (excl. lamp)	1	8WD4400-1AB	31.75	41J
Signalling element, green (excl. lamp)	2	8WD4400-1AC	31.75	41J
Signalling element, orange (excl. lamp)	3	8WD4400-1AD	31.75	41J
Signalling element, clear (excl. lamp)	4	8WD4400-1AE	31.75	41J
Signalling element, blue (excl. lamp)	5	8WD4400-1AF	31.75	41J
<b>Signalling element, optical, plastic, diameter 70mm, IP 65, max. 5 units, screw terminal, integrated LED, flashing, 24 V AC / DC:</b>				
Signalling element, flashing, red	1	8WD4420-5BB	80.46	41J
Signalling element, flashing, green	2	8WD4420-5BC	80.46	41J
Signalling element, flashing, orange	3	8WD4420-5BD	80.46	41J
<b>Signalling element, acoustic, plastic, diameter 70mm, IP 65, screw terminal, 24 V AC / DC:</b>				
Buzzer element, 85dB	6	8WD4420-0FA	60.38	41J
Multitone siren element, 100dB	6	8WD4420-0EA2	88.44	41J
Siren element, 108dB (IP40)	6	8WD4420-0EA	61.42	41J
<b>AS interface adapter element, diameter 70mm, IP 65, 24 V AC / DC:</b>				
AS interface adapter element for 8WD44 series, A/B technology, max. 3 signalling elements, 24 V DC	7	8WD4428-0BD	170.75	41J
AS interface adapter element for 8WD44 series, Standard AS-i, max. 4 signalling elements, 24 V DC	7	8WD4428-0BE	167.06	41J
<b>IO-Link adapter element, diameter 70mm, IP 65, 24 V DC:</b>				
IO-Link adapter element for 8WD44 series, max. 5 signalling elements, 24 V DC	8	8WD4428-0BF	205.76	41J
<b>Flush mount signalling lamps, optical, diameter 70mm, IP 65, screw terminal, integrated LED, steady, 24 V AC / DC:</b>				
Signalling element, steady, red	9	8WD5320-5AB	111.17	41J
Signalling element, steady, green	10	8WD5320-5AC	111.17	41J
Signalling element, steady, orange	11	8WD5320-5AD	111.17	41J
<b>Flush mount signalling lamps, optical, plastic, diameter 70mm, IP 65, screw terminal, BA15d lamp socket, 12-230 V AC / DC:</b>				
Signalling element, red (excl. lamp)	9	8WD5300-1AB	42.01	41J
Signalling element, green (excl. lamp)	10	8WD5300-1AC	42.01	41J
Signalling element, orange (excl. lamp)	11	8WD5300-1AD	42.01	41J
Signalling element, clear (excl. lamp)	12	8WD5300-1AE	42.01	41J
Signalling element, blue (excl. lamp)	13	8WD5300-1AF	42.01	41J
<b>Accessories for signalling columns:</b>				
Connection element + cover, for pipe mounting, screw terminals	14	8WD4408-0AA	35.93	41J
Connection element + cover, for mounting on foot/wall bracket, screw terminals	14	8WD4408-0AB	35.38	41J
Foot with 100 mm pipe (for use with 8WD4408-0AA)	15	8WD4308-0DA	31.88	41J
Plastic foot, for mounting on ≤ 400mm pipe (for use with 8WD4408-0AA)	16	8WD4308-0DB	17.93	41J
Metal foot, for mounting on ≤ 400mm pipe (for use with 8WD4408-0AA)	16	8WD4308-0DC	38.39	41J
Plastic foot, adjustable 7.5° for mounting on pipe (for use with 8WD4408-0AA)	17	8WD4408-0DF	66.95	41J
Pipe, aluminium, 150mm	18	8WD4308-0EE	29.60	41J
Pipe, aluminium, 250mm	18	8WD4308-0EA	20.08	41J
Pipe, aluminium, 400mm	18	8WD4308-0EB	27.33	41J
Pipe, aluminium, 1000mm	18	8WD4308-0ED	64.49	41J
Wall bracket (for use with 8WD4408-0AB)	19	8WD4308-0CA	20.33	41J
Wall bracket with cable gland (for use with 8WD4408-0AB)	20	8WD4408-0CD	15.36	41J
Lamp BA15d, 24 V AC / DC (min. order 10 pcs)	21	8WD4328-1XX	6.09	41J
Lamp BA15d, 115 V AC (min. order 10 pcs)	21	8WD4348-1XX	6.09	41J
Lamp BA15d, 230 V AC (min. order 10 pcs)	21	8WD4358-1XX	6.09	41J
LED BA15d, red, 24 V AC / DC	21	8WD4428-6XB	39.00	41J

\*For more models and comprehensive technical information, please see the Industrial Controls catalogue: IC 10 2021. For the latest information, visit the Industry Mall: [www.siemens.com/industrymall/gb](http://www.siemens.com/industrymall/gb)

# Non-contact Safety Switches

## Non-contact Safety Switches - SIRIUS 3SE6\*



Description:	Fig.	Order number	L Price £	Prod. group
<b>Plastic safety magnets, IP67:</b>				
Switch block for door hinge left, 26x36mm, 1NO+1NC, M8 plug connector	1	3SE6616-3CA01	74.32	41K
Switch block for door hinge left, 26x36mm, 2NC, M8 plug connector	1	3SE6617-3CA01	74.32	41K
Switch block for door hinge left, 26x36mm, 2NC, 3m cable	2	3SE6617-3CA04	73.09	41K
Switch block for door hinge right, 26x36mm, 1NO+1NC, M8 plug connector	3	3SE6626-3CA01	74.32	41K
Switch block for door hinge right, 26x36mm, 2NC, M8 plug connector	3	3SE6627-3CA01	74.32	41K
Switch block for door hinge right, 26x36mm, 2NC, 3m cable	4	3SE6627-3CA04	73.09	41K
Switching magnet, 26x36mm hinge left	5	3SE6714-3CA	14.25	41K
Switching magnet, 26x36mm hinge right	6	3SE6724-3CA	14.25	41K
Switching magnet, 25x88mm, coded	7-8	3SE6704-2BA	15.23	41K
Switch block, 25x88mm, 1NO+1NC, 3m cable	9	3SE6605-2BA	49.14	41K
Switch block, 25x88mm, 2NC, 3m cable	9	3SE6604-2BA	62.65	41K
Switch block, 25x88mm, 1NO+1NC, M8 plug connector	9	3SE6605-2BA01	64.49	41K
Switch block, 25x88mm, 2NC, M8 plug connector	9	3SE6604-2BA01	78.00	41K
Switching magnet, 25x33mm, coded	9	3SE6704-3BA	15.23	41K
Switch block, 25x33mm, 1NO+1NC, 3m cable	10	3SE6605-3BA	49.14	41K
Switching magnet, round 30mm, coded	11	3SE6704-1BA	21.50	41K
Switch block, round 30mm, 1NO+1NC, 3m cable	12	3SE6605-1BA	54.30	41K
<b>Accessories for safety magnets:</b>				
Fill-up element 25x88mm	13	3SX3260	8.84	41K
Fill-up element 25x33mm	14	3SX3261	8.84	41K
<b>Non-Contact RFID Safety Switches</b>				
Family coded, M12 plug	15	3SE6315-0BB01	124.68	41K
Family coded, M12 plug with magnetic latching	15	3SE6315-1BB01	181.19	41K
Individually coded, Multiple teach-in capability, M12 plug	15	3SE6315-0BB02	184.26	41K
Individually coded, Multiple teach-in capability, M12 plug with magnetic latching	15	3SE6315-1BB02	230.33	41K
Individually coded, Single teach-in capability, M12 plug	15	3SE6315-0BB03	201.46	41K
Individually coded, Single teach-in capability, M12 plug with magnetic latching	15	3SE6315-1BB03	251.21	41K
RFID actuator standard	16	3SE6310-0BC01	23.95	41K
RFID actuator with magnetic latching 18N	16	3SE6310-1BC01	78.00	41K
<b>Non-contact Safety Switch Accessories</b>				
8 Pin Cable, M12, 3m	17	3SX5601-2GA03	29.73	41K
8 Pin Cable, M12, 10m	17	3SX5601-2GA10	42.93	41K
M8 Coupling with connecting cable 5m long, for M8 Connector 4-Pole, for 3SE66	18	3SX5601-3GA05	24.38	41K
Coupling with connecting cable 5m long, with 8mm catch connecto, 6-pole for 3SE66	19	3SX5601-4GA05	30.65	41K
Couple Gland M20	20	3SX5601-1A	5.31	41K

## Flush mount (emergency-stop) pushbuttons & signalling lamps - SIRIUS 3SU1



Description:	Fig.	Order number	L Price £	Prod. group
<b>Emergency-stop pushbuttons, plastic, flush mount, round 22mm, IP69K:</b> (Delivery excl. contact block and holder. Consult pushbutton accessories for contact blocks needed.)				
Emergency-stop pushbutton, plastic, 40mm dia., turn to unlatch	1	3SU1000-1HB20-0AA0	17.44	41J
Emergency-stop pushbutton, plastic, 60mm dia., turn to unlatch	2	3SU1000-1JB20-0AA0	19.66	41J
Emergency-stop pushbutton, plastic, 40mm dia., with CES lock, turn to unlatch	3	3SU1000-1HR20-0AA0	54.16	41J
Emergency-stop pushbutton, plastic, 40mm dia., pull to unlatch	4	3SU1000-1HA20-0AA0	16.05	41J
Illuminated Emergency-stop pushbutton, plastic, 40mm dia., turn to unlatch	5	3SU1001-1HB20-0AA0	20.73	41J

\*For more models and comprehensive technical information, please see the Industrial Controls catalogue: IC 10 2021. For the latest information, visit the Industry Mall: [www.siemens.com/industrymall/gb](http://www.siemens.com/industrymall/gb)

# Pushbuttons & signalling lamps - flush mount

## Flush mount (emergency-stop) pushbuttons & signalling lamps - SIRIUS 3SU1\* (continued)



Description:	Fig.	Order number	L Price £	Prod. group
<b>Pushbuttons/signalling lamps, plastic, flush mount, round 22mm, IP69K:</b>				
Pushbutton, flat, plastic, black	6	3SU1000-0AB10-0AA0	3.86	41J
Pushbutton, flat, plastic, red	7	3SU1000-0AB20-0AA0	3.86	41J
Pushbutton, flat, plastic, yellow	8	3SU1000-0AB30-0AA0	3.86	41J
Pushbutton, flat, plastic, green	9	3SU1000-0AB40-0AA0	3.86	41J
Pushbutton, flat, plastic, blue	10	3SU1000-0AB50-0AA0	3.86	41J
Pushbutton, flat, plastic, white	11	3SU1000-0AB60-0AA0	3.86	41J
Pushbutton, flat, plastic, clear	12	3SU1000-0AB70-0AA0	3.86	41J
Illuminated pushbutton, flat, plastic, red	13	3SU1001-0AB20-0AA0	5.30	41J
Illuminated pushbutton, flat, plastic, yellow	14	3SU1001-0AB30-0AA0	5.30	41J
Illuminated pushbutton, flat, plastic, green	15	3SU1001-0AB40-0AA0	5.30	41J
Illuminated pushbutton, flat, plastic, blue	16	3SU1001-0AB50-0AA0	5.30	41J
Illuminated pushbutton, flat, plastic, white	17	3SU1001-0AB60-0AA0	5.30	41J
Illuminated pushbutton, flat, plastic, clear	18	3SU1001-0AB70-0AA0	5.30	41J
Selector switch, plastic, black, white, 2 positions, latching, O / I	19	3SU1002-2BF60-0AA0	8.22	41J
Selector switch, plastic, black, white, 2 positions, momentary contact type, O / I	19	3SU1002-2BC60-0AA0	8.22	41J
Selector switch, plastic, black, white, 3 positions, latching, I / O / II	19	3SU1002-2BL60-0AA0	8.22	41J
Selector switch, plastic, black, white, 3 positions, momentary contact type, I / O / II	19	3SU1002-2BM60-0AA0	8.22	41J
Key switch, CES, plastic, latching, O / I, key removable in 2 positions	20	3SU1000-5BF11-0AA0	49.17	41J
<b>Illuminated twin pushbuttons, plastic, flush mount, round 22mm, IP69K:</b> (Delivery excl. contact block and holder. Consult pushbutton accessories for contact blocks needed.)				
Illuminated twin pushbuttons, flat, plastic, green/red, 2 pos., I / O	21	3SU1001-3AB42-0AK0	9.10	41J
Illuminated twin pushbuttons, flat, plastic, white/black, 2 pos., I / O	22	3SU1001-3AB61-0AK0	9.10	41J
<b>Emergency-stop pushbuttons, metal, flush mount, 22mm, IP69K:</b> (Delivery excl. contact block and holder. Consult pushbutton accessories for contact blocks needed.)				
Emergency-stop pushbutton, metal, 40mm dia., turn to unlatch	23	3SU1050-1HB20-0AA0	17.63	41J
Emergency-stop pushbutton, metal, 60mm dia., turn to unlatch	24	3SU1050-1JB20-0AA0	19.59	41J
Emergency-stop pushbutton, metal, 40mm dia., with CES lock, turn to unlatch	25	3SU1050-1HR20-0AA0	58.97	41J
Emergency pushbutton, metal, 40mm dia., pull to unlatch	26	3SU1050-1HA20-0AA0	17.63	41J
Illuminated Emergency-stop pushbutton, metal, 40mm dia., turn to unlatch	27	3SU1051-1HB20-0AA0	22.06	41J
<b>Pushbuttons/signalling lamps, metal, flush mount, round 22mm, IP69K:</b> (Delivery excl. contact block and holder. Consult pushbutton accessories for contact blocks needed.)				
Pushbutton, flat, metal, black	28	3SU1050-0AB10-0AA0	4.96	41J
Pushbutton, flat, metal, red	29	3SU1050-0AB20-0AA0	4.96	41J
Pushbutton, flat, metal, yellow	30	3SU1050-0AB30-0AA0	4.96	41J
Pushbutton, flat, metal, green	31	3SU1050-0AB40-0AA0	4.96	41J
Pushbutton, flat, metal, blue	32	3SU1050-0AB50-0AA0	4.96	41J
Pushbutton, flat, metal, white	33	3SU1050-0AB60-0AA0	4.96	41J
Pushbutton, flat, metal, clear	34	3SU1050-0AB70-0AA0	4.96	41J
Illuminated pushbutton, flat, metal, red	35	3SU1051-0AB20-0AA0	5.98	41J
Illuminated pushbutton, flat, metal, yellow	36	3SU1051-0AB30-0AA0	5.98	41J
Illuminated pushbutton, flat, metal, green	37	3SU1051-0AB40-0AA0	5.98	41J
Illuminated pushbutton, flat, metal, blue	38	3SU1051-0AB50-0AA0	5.98	41J
Illuminated pushbutton, flat, metal, white	39	3SU1051-0AB60-0AA0	5.98	41J
Illuminated pushbutton, flat, metal, clear	40	3SU1051-0AB70-0AA0	5.98	41J
Selector switch can be illuminated, metal, black, white, 2 positions, latching, O / I	41	3SU1052-2BF60-0AA0	9.16	41J
Selector switch can be illuminated, metal, black, white, 2 positions, momentary contact type, O / I	41	3SU1052-2BC60-0AA0	9.16	41J
Selector switch can be illuminated, metal, black, white, 3 positions, latching, I / O / II	41	3SU1052-2BL60-0AA0	9.16	41J
Selector switch can be illuminated, metal, black, white, 3 positions, momentary contact type, I / O / II	41	3SU1052-2BM60-0AA0	9.16	41J
Key switch, CES, metal, latching, O / I, key removable in 2 positions	42	3SU1050-5BF11-0AA0	53.28	41J

\*For more models and comprehensive technical information, please see the Industrial Controls catalogue: IC 10 2021. For the latest information, visit the Industry Mall: [www.siemens.com/industrymall/gb](http://www.siemens.com/industrymall/gb)



# Pushbuttons & signalling lamps - flush mount

Flush mount (emergency-stop) pushbuttons & signalling lamps - SIRIUS 3SU1\* (continued)

Pushbuttons and signalling lamps, round 16mm: see catalogue: IC 10 2019 catalogue



43 44 45



46 47 48



49 50 51



52 53 54



55 56

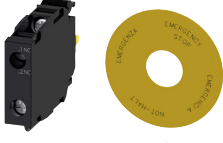

57 58



59

Description:	Fig.	Order number	L Price £	Prod. group
<b>Indicator lamps, plastic, front panel, round 22mm, IP69K:</b> (Delivery excl. contact block and holder. Consult pushbutton accessories for contact blocks needed.)				
Indicator lights with smooth lens, plastic, red	43	3SU1001-6AA20-0AA0	3.07	41J
Indicator lights with smooth lens, plastic, yellow	44	3SU1001-6AA30-0AA0	3.07	41J
Indicator lights with smooth lens, plastic, green	45	3SU1001-6AA40-0AA0	3.07	41J
Indicator lights with smooth lens, plastic, blue	46	3SU1001-6AA50-0AA0	3.07	41J
Indicator lights with smooth lens, plastic, white	47	3SU1001-6AA60-0AA0	3.07	41J
Indicator lights with smooth lens, plastic, clear	48	3SU1001-6AA70-0AA0	3.07	41J
<b>Indicator lamps, metal, front panel, round 22mm, IP69K:</b> (Delivery excl. contact block and holder. Consult pushbutton accessories for contact blocks needed.)				
Indicator lights with smooth lens, metal, red	49	3SU1051-6AA20-0AA0	3.59	41J
Indicator lights with smooth lens, metal, yellow	50	3SU1051-6AA30-0AA0	3.59	41J
Indicator lights with smooth lens, metal, green	51	3SU1051-6AA40-0AA0	3.59	41J
Indicator lights with smooth lens, metal, blue	52	3SU1051-6AA50-0AA0	3.59	41J
Indicator lights with smooth lens, metal, white	53	3SU1051-6AA60-0AA0	3.59	41J
Indicator lights with smooth lens, metal, clear	54	3SU1051-6AA70-0AA0	3.59	41J
<b>Accessories for front panel pushbuttons/signalling lamps:</b>				
Contact block 1NC, screw terminals (sold in multiple of 5)	55	3SU1400-1AA10-1CA0	3.92	41J
Contact block 1NO, screw terminals (sold in multiple of 5)	55	3SU1400-1AA10-1BA0	3.92	41J
Contact block 1NC, screw terminals	55	3SU1400-1AA10-1CA0-ZX01	4.70	41J
Contact block 1NO, screw terminals	55	3SU1400-1AA10-1BA0-ZX01	4.70	41J
Contact block 1NC + 1NC, screw terminals	56	3SU1400-1AA10-1FA0	6.38	41J
Contact block 2NO, screw terminals	56	3SU1400-1AA10-1DA0	8.85	41J
Contact block 2NC, screw terminals	56	3SU1400-1AA10-1EA0	8.85	41J
Contact block with mounting monitoring 1NC, screw terminals	57	3SU1400-1AA10-1HA0	9.48	41J
Yellow backing plate for emergency stop, round 80 mm (sticker), w/o inscription	58	3SU1900-0BC31-0AA0	4.38	41J
Yellow backing plate for emerg. stop, round 75 mm (sticker), 4 language (EN/DE/IT/SP)	58	3SU1900-0BC31-0NBO	4.89	41J
LED Module with integrated LED, yellow, 24 V AC / DC, screw terminals (sold in multiple of 5)	59	3SU1401-1BB30-1AA0	6.32	41J
LED Module with integrated LED, red, 24 V AC / DC, screw terminals (sold in multiple of 5)	59	3SU1401-1BB20-1AA0	6.32	41J
LED Module with integrated LED, green, 24 V AC / DC, screw terminals (sold in multiple of 5)	59	3SU1401-1BB40-1AA0	6.32	41J
LED Module with integrated LED, blue, 24 V AC / DC, screw terminals (sold in multiple of 5)	59	3SU1401-1BB50-1AA0	6.32	41J
LED Module with integrated LED, white, 24 V AC / DC, screw terminals (sold in multiple of 5)	59	3SU1401-1BB60-1AA0	6.32	41J
LED Module with integrated LED, yellow, 24 V AC / DC, screw terminals	59	3SU1401-1BB30-1AA0-ZX01	7.58	41J
LED Module with integrated LED, red, 24 V AC / DC, screw terminals	59	3SU1401-1BB20-1AA0-ZX01	7.58	41J
LED Module with integrated LED, green, 24 V AC / DC, screw terminals	59	3SU1401-1BB40-1AA0-ZX01	7.58	41J
LED Module with integrated LED, blue, 24 V AC / DC, screw terminals	59	3SU1401-1BB50-1AA0-ZX01	7.58	41J
LED Module with integrated LED, white, 24 V AC / DC, screw terminals	59	3SU1401-1BB60-1AA0-ZX01	7.58	41J
LED Module with integrated LED, yellow, 110 V AC, screw terminals	59	3SU1401-1BC30-1AA0	10.55	41J
LED Module with integrated LED, red, 110 V AC, screw terminals	59	3SU1401-1BC20-1AA0	10.55	41J
LED Module with integrated LED, green, 110 V AC, screw terminals	59	3SU1401-1BC40-1AA0	10.55	41J
LED Module with integrated LED, blue, 110 V AC, screw terminals	59	3SU1401-1BC50-1AA0	10.55	41J
LED Module with integrated LED, white, 110 V AC, screw terminals	59	3SU1401-1BC60-1AA0	10.55	41J
LED Module with integrated LED, yellow, 230 V AC, screw terminals	59	3SU1401-1BF30-1AA0	10.55	41J
LED Module with integrated LED, red, 230 V AC, screw terminals	59	3SU1401-1BF20-1AA0	10.55	41J
LED Module with integrated LED, green, 230 V AC, screw terminals	59	3SU1401-1BF40-1AA0	10.55	41J
LED Module with integrated LED, blue, 230 V AC, screw terminals	59	3SU1401-1BF50-1AA0	10.55	41J
LED Module with integrated LED, white, 230 V AC, screw terminals	59	3SU1401-1BF60-1AA0	10.55	41J
<b>LED modules for front panel mounting: ATEX Zone 1-2: intrinsic safety:</b>				
LED Module with integrated LED, yellow, 24 V AC / DC, screw terminals	59	3SU1401-1BB30-1AA2	15.42	41J
LED Module with integrated LED, red, 24 V AC / DC, screw terminals	59	3SU1401-1BB20-1AA2	15.42	41J
LED Module with integrated LED, green, 24 V AC / DC, screw terminals	59	3SU1401-1BB40-1AA2	15.42	41J
LED Module with integrated LED, blue, 24 V AC / DC, screw terminals	59	3SU1401-1BB50-1AA2	15.42	41J
LED Module with integrated LED, white, 24 V AC / DC, screw terminals	59	3SU1401-1BB60-1AA2	15.42	41J

\*Contact blocks are stackable.

\*For more models and comprehensive technical information, please see the Industrial Controls catalogue: IC 10 2021. For the latest information, visit the Industry Mall: [www.siemens.com/industrymall/gb](http://www.siemens.com/industrymall/gb)

# Pushbutton enclosures - surface mount

## Holders for pushbuttons & signalling lamps - SIRIUS 3SU1



Description:	Fig.	Order number	L Price £	Prod. group
<b>Accessories for flush-mount pushbuttons/signalling lamps:</b>				
Holder for 3 modules, plastic (sold in multiple of 5)	60	3SU1500-0AA10-0AA0	1.89	41J
Holder for 3 modules, universal (sold in multiple of 5)	61	3SU1550-0AA10-0AA0	2.72	41J
Holder for 3 modules, metal (sold in multiple of 5)	62	3SU1510-0AA10-0AA0	4.13	41J
Holder for 3 modules, plastic	60	3SU1500-0AA10-0AA0-ZX01	2.36	41J
Holder for 3 modules, universal	61	3SU1550-0AA10-0AA0-ZX01	3.27	41J
Holder for 3 modules, metal	62	3SU1510-0AA10-0AA0-ZX01	4.95	41J

## Surface mount (emergency-stop) pushbutton enclosures - SIRIUS 3SU1

Loose pushbuttons/signalling lamps for fitting into the pushbutton enclosures can be found on page 21 under "Flush mount (emergency-stop) pushbuttons & signalling lamps".

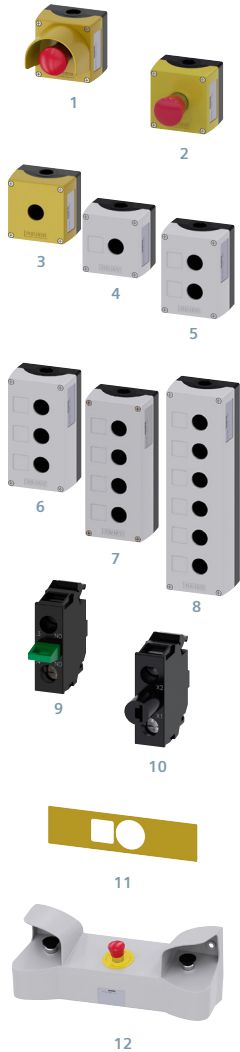

Description:	Fig.	Order number	L Price £	Prod. group
<b>Emergency-stop pushbutton enclosures complete, plastic enclosure, 2xM20 cable entry, with 22mm round actuators, IP69K:</b>				
Emergency-stop pushbutton enclosure, turn to unlatch, with protective collar, 2NC contacts	1	3SU1801-0NB00-2AC2	57.20	41J
<b>Emergency-stop pushbutton enclosures complete, metal enclosure, 2xM20 cable entry, with 22mm round actuators, IP69K:</b>				
Emergency-stop pushbutton enclosure, turn to unlatch, with protective collar, 2NC contacts	1	3SU1851-0NB00-2AC2	100.49	41J
Emergency-stop pushbutton enclosure, turn to unlatch, 2NC contacts	2	3SU1851-0NB00-2AA2	67.62	41J
<b>Pushbutton enclosures, empty, metal enclosure 2xM20 cable entry, for 22mm round actuators, IP69K:</b>				
Pushbutton enclosure, 1 position, yellow top part	3	3SU1851-0AA00-0AA2	31.28	41J
Pushbutton enclosure, 1 position, grey top part	4	3SU1851-0AA00-0AB1	27.18	41J
Pushbutton enclosure, 2 positions, grey top part	5	3SU1852-0AA00-0AB1	32.67	41J
Pushbutton enclosure, 3 positions, grey top part	6	3SU1853-0AA00-0AB1	43.23	41J
Pushbutton enclosure, 4 positions, grey top part	7	3SU1854-0AA00-0AB1	57.26	41J
Pushbutton enclosure, 6 positions, grey top part	8	3SU1856-0AA00-0AB1	74.58	41J
<b>Pushbutton enclosure accessories:</b>				
Contact block, bottom mount, 1NC, screw terminal (sold in multiple of 5)	9	3SU1400-2AA10-1CA0	4.79	41J
Contact block, bottom mount, 1NO, screw terminal (sold in multiple of 5)	9	3SU1400-2AA10-1BA0	4.79	41J
Contact block, bottom mount, 1NC, screw terminal	9	3SU1400-2AA10-1CA0-ZX01	5.75	41J
Contact block, bottom mount, 1NO, screw terminal	9	3SU1400-2AA10-1BA0-ZX01	5.75	41J
LED module, yellow, bottom mount, 24 V AC / DC, screw terminal (sold in multiple of 5)	10	3SU1401-2BB30-1AA0	6.51	41J
LED module, red, bottom mount, 24 V AC / DC, screw terminal (sold in multiple of 5)	10	3SU1401-2BB20-1AA0	6.51	41J
LED module, green, bottom mount, 24 V AC / DC, screw terminal (sold in multiple of 5)	10	3SU1401-2BB40-1AA0	6.51	41J
LED module, blue, bottom mount, 24 V AC / DC, screw terminal (sold in multiple of 5)	10	3SU1401-2BB50-1AA0	6.51	41J
LED module, white, bottom mount, 24 V AC / DC, screw terminal (sold in multiple of 5)	10	3SU1401-2BB60-1AA0	6.51	41J
LED module, yellow, bottom mount, 24 V AC / DC, screw terminal	10	3SU1401-2BB30-1AA0-ZX01	8.03	41J
LED module, red, bottom mount, 24 V AC / DC, screw terminal	10	3SU1401-2BB20-1AA0-ZX01	8.03	41J
LED module, green, bottom mount, 24 V AC / DC, screw terminal	10	3SU1401-2BB40-1AA0-ZX01	8.03	41J
LED module, blue, bottom mount, 24 V AC / DC, screw terminal	10	3SU1401-2BB50-1AA0-ZX01	8.03	41J
LED module, white, bottom mount, 24 V AC / DC, screw terminal	10	3SU1401-2BB60-1AA0-ZX01	8.03	41J
LED module, yellow, bottom mount, 110 V AC, screw terminal	10	3SU1401-2BC30-1AA0	12.26	41J
LED module, red, bottom mount, 110 V AC, screw terminal	10	3SU1401-2BC20-1AA0	12.26	41J
LED module, green, bottom mount, 110 V AC, screw terminal	10	3SU1401-2BC40-1AA0	12.26	41J
LED module, blue, bottom mount, 110 V AC, screw terminal	10	3SU1401-2BC50-1AA0	12.26	41J
LED module, white, bottom mount, 110 V AC, screw terminal	10	3SU1401-2BC60-1AA0	12.26	41J
LED module, yellow, bottom mount, 230 V AC, screw terminal	10	3SU1401-2BF30-1AA0	12.26	41J
LED module, red, bottom mount, 230 V AC, screw terminal	10	3SU1401-2BF20-1AA0	12.26	41J
LED module, green, bottom mount, 230 V AC, screw terminal	10	3SU1401-2BF40-1AA0	12.26	41J
LED module, blue, bottom mount, 230 V AC, screw terminal	10	3SU1401-2BF50-1AA0	12.26	41J
LED module, white, bottom mount, 230 V AC, screw terminal	10	3SU1401-2BF60-1AA0	12.26	41J
Yellow backing plate for emergency stop, (sticker), with recess for labelling plate	11	3SU1900-0BF31-0AA0	4.62	41J
Two hand operation console for command devices, 3 command points metal	12	3SU1853-3NB00-1AA1	434.82	41J
<b>LED modules for bottom mount: ATEX Zone 1-2: intrinsic safety:</b>				
LED module, yellow, bottom mount, 24 V AC / DC, screw terminal	10	3SU1401-2BB30-1AA2	16.18	41J
LED module, red, bottom mount, 24 V AC / DC, screw terminal	10	3SU1401-2BB20-1AA2	16.18	41J
LED module, green, bottom mount, 24 V AC / DC, screw terminal	10	3SU1401-2BB40-1AA2	16.18	41J
LED module, blue, bottom mount, 24 V AC / DC, screw terminal	10	3SU1401-2BB50-1AA2	16.18	41J
LED module, white, bottom mount, 24 V AC / DC, screw terminal	10	3SU1401-2BB60-1AA2	16.18	41J

The SIRIUS Act Configurator Tool allows you to create your own Pushbutton enclosures: [www.siemens.com/sirius-act/configurator](http://www.siemens.com/sirius-act/configurator)  
Pushbuttons and signalling lamps, round 16mm and square 26mm: see catalogue: IC 10 2021 catalogue

\*For more models and comprehensive technical information, please see the Industrial Controls catalogue: IC 10 2021. For the latest information, visit the Industry Mall: [www.siemens.com/industrymall/gb](http://www.siemens.com/industrymall/gb)

# Pushbuttons with Profinet

## Profinet gateway - SIRIUS 3SU1

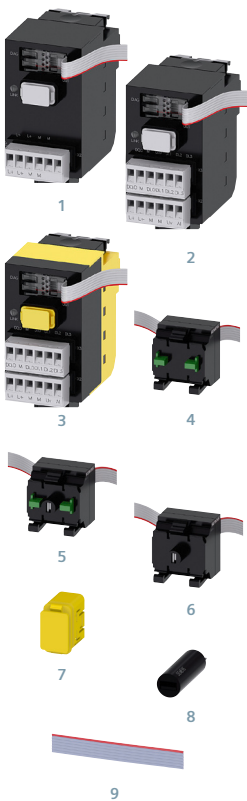

Description:	Fig.	Order number	L Price £	Prod. group
<b>Profinet Interface Modules</b>				
Standard IM, 24 V DC, 1–20 TMs connectable, screw terminals	1	3SU1400-1LK10-1AA1	210.46	41J
Standard IM, 24 V DC, 1–20 TMs connectable, 4 DI, 1 DQ, 1 AI, screw terminals	2	3SU1400-1LK10-1BA1	285.66	41J
Fail-safe IM F, 24 V DC, 1–20 TMs connectable, 4 DI, 1 DQ, 1 AI, screw terminals	3	3SU1400-1LL10-1BA1	328.64	41J
<b>Profinet terminal modules</b>				
“Commands” TM with 2 spring contacts	4	3SU1400-1MA10-1BA1	31.66	41J
“Commands and LED” TM with 2 spring contacts and integrated red LED	5	3SU1401-1MC20-1CA1	33.18	41J
“Commands and LED” TM with 2 spring contacts and integrated yellow LED	5	3SU1401-1MC30-1CA1	33.18	41J
“Commands and LED” TM with 2 spring contacts and integrated green LED	5	3SU1401-1MC40-1CA1	33.18	41J
“Commands and LED” TM with 2 spring contacts and integrated blue LED	5	3SU1401-1MC50-1CA1	33.18	41J
“Commands and LED” TM with 2 spring contacts and integrated white LED	5	3SU1401-1MC60-1CA1	33.18	41J
“Commands and LED” TM with 2 spring contacts and integrated amber LED	5	3SU1401-1MC00-1CA1	33.18	41J
“LED” TM with integrated red LED	6	3SU1401-1ME20-1DA1	30.72	41J
“LED” TM with integrated yellow LED	6	3SU1401-1ME30-1DA1	30.72	41J
“LED” TM with integrated green LED	6	3SU1401-1ME40-1DA1	30.72	41J
“LED” TM with integrated blue LED	6	3SU1401-1ME50-1DA1	30.72	41J
“LED” TM with integrated white LED	6	3SU1401-1ME60-1DA1	30.72	41J
“LED” TM with integrated amber LED	6	3SU1401-1ME00-1DA1	30.72	41J
<b>Accessories</b>				
Memory module for storage of configuration data, optional for IM, included for IM F	7	3RK3931-0AA00	23.52	42C
LED module, red, only illuminated for IM/IM F and SIRIUS ACT	8	3SU1401-3BA20-5AA0	14.92	41J
LED module, yellow, only illuminated for IM/IM F and SIRIUS ACT	8	3SU1401-3BA30-5AA0	14.92	41J
LED module, green, only illuminated for IM/IM F and SIRIUS ACT	8	3SU1401-3BA40-5AA0	14.92	41J
LED module, blue, only illuminated for IM/IM F and SIRIUS ACT	8	3SU1401-3BA50-5AA0	14.92	41J
LED module, white, only illuminated for IM/IM F and SIRIUS ACT	8	3SU1401-3BA60-5AA0	14.92	41J
LED module, amber, only illuminated for IM/IM F and SIRIUS ACT	8	3SU1401-3BA00-5AA0	14.92	41J
Flat ribbon cable, 7-core, cable length 5 m	9	3SU1900-0KQ80-0AA0	8.03	41J
Flat ribbon cable, 7-core, cable length 10 m	9	3SU1900-0KP80-0AA0	16.05	41J

### Communication via Profinet Advantages

- Reduced wiring time - fewer sources of error during installation and commissioning
- Modular and plug-in design of all components
- No addressing of individual push buttons and command points required – only one IP address for up to 21 devices
- Diagnostics and Parameterization via the TIA-Portal
- Safety Integrated – making it possible to integrate safety technology; e.g. emergency stop with safety-related Interface Module via PROFIsafe communication
- Easy replacement of memory modules without programming knowledge

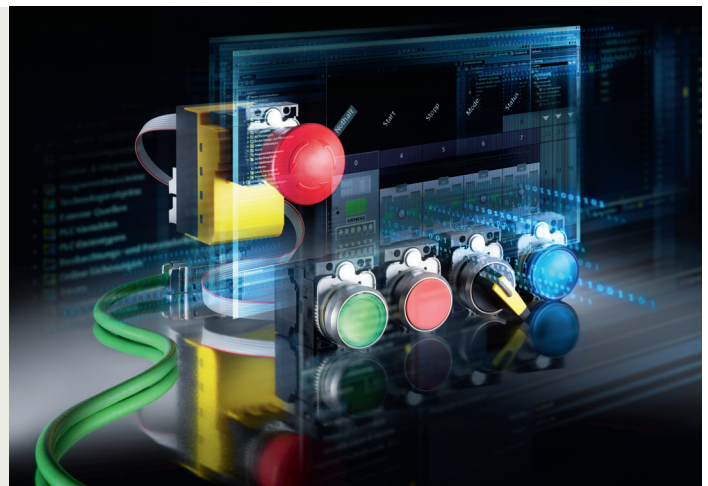

\*You can find all information at: [www.siemens.com/sirius-act-profinet](http://www.siemens.com/sirius-act-profinet) or visit the Industry Mall: [www.siemens.com/industrymallgb](http://www.siemens.com/industrymallgb). Technical specifications: [www.siemens.com/sios](http://www.siemens.com/sios).

## Profinet gateway - SIRIUS 3SU1

Communication is one of the strong points of SIRIUS ACT: Besides the standard wiring, you can also connect the push buttons and signaling devices directly to the controller in the field or cabinet via PROFINET, AS-Interface and IO-Link. In this way, you can reduce wiring time and effort, minimize error sources and have more flexibility when you need to make modifications. Engineering in the Totally Integrated Automation Portal (TIA Portal) provides additional diagnostics and parameterization options. SIRIUS ACT push buttons and indicator lights – convincing in design, performance, ruggedness and handling. Enabling you to get things going.

### Top performance thanks to strong communication

SIRIUS ACT with PROFINET connects push buttons and signaling devices directly with the controller and HMI devices via PROFINET – including safety functions, with engineering and commissioning being simplified no end by the TIA Portal. Additional benefits include uniform data management, shorter downtimes thanks to faster fault diagnostics and option handling, which can be used to flexibly design plants and systems and even modify them during operation.

Detailed installation information available at: [siemens.com/sirius-act-profinet-manual](https://www.siemens.com/sirius-act-profinet-manual)

### SIRIUS ACT PROFINET

All devices that are not safety-related can be integrated easily with the interface module (IM).

1. CPU
2. Standard Interfacemodul
3. Terminalmodul

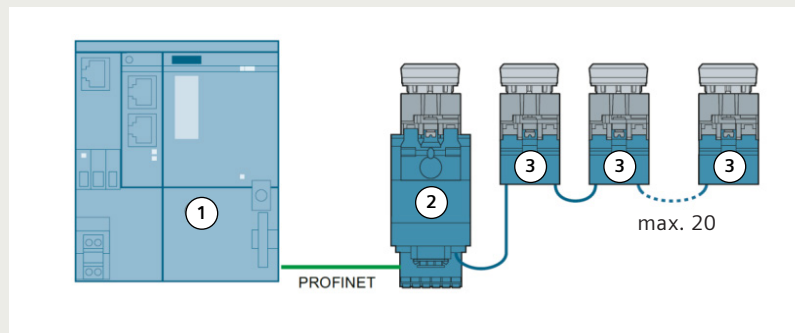

### SIRIUS ACT PROFINET/PROFIsafe

If there is a safety-related SIRIUS ACT device (e.g. EMERGENCY STOP up to SIL 3) in the application, it can be integrated easily via the fail-safe interface module (IM F).  
If safety-related, then connection to IM F.

1. CPU
2. Fail-safe Interfacemodul
3. Terminalmodul

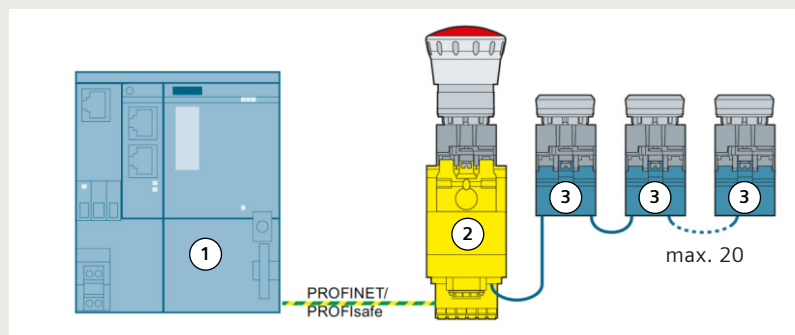

### System Overview - Flexible for all types of applications

Components:	1 Interfacemodul + max. 20 Terminalmoduls
Max. Cable length between Moduls:	1 Meter
Total cable length (IM – TM):	10 Meters
Power Supply:	24 V DC
E-Stop:	if needed, only on the first position on the Fail-safe version

# Application examples & reference materials

## Sensor wiring

### Parameter definitions depending on the sensor wiring

Slide switch		Description	Typical circuit	
AUTO	MONITORED		Basic unit 3SK1	Standard relay
	✓	EMERGENCY STOP, single-channel, with monitored start	1 and 2	
✓		EMERGENCY STOP, single-channel, with autostart	3 and 4	
	✓	Two-channel, with cross-circuit detection, with monitored start	5	
✓		Two-channel, with cross-circuit detection, with autostart	6	
✓		Sensors with solid-state outputs, without crosscircuit detection, with autostart	7	

DIP switch				Description	Typical circuit	
1	2	3	4		Basic units 3SK1	Standard / Advanced
right	right	right	-	1 x two-channel, with cross-circuit detection, with monitored start	8	
left	right	right	-	1 x two-channel, with cross-circuit detection with autostart	9	
right	left	right	-	Electronic sensor, without cross-circuit detection, with monitored start	10	
left	left	right	-	Electronic sensor, without cross-circuit detection, with autostart	11	
right	left	left	-	2 x single-channel, without cross-circuit detection, with monitored start	12	
left	left	left	-	2x single-channel, without cross-circuit detection, with autostart	13	

- not relevant

DIP switch				Description	Typical circuit	
1	2	3	4		Basic units 3SK1	Advanced
right	right	right	-	1NC/1NO sensor, with cross-circuit detection, with monitored start	14	
left	right	right	-	1NC/1NO sensor, with cross-circuit detection, with autostart	15	
left	right	right	-	Two-hand operation, with cross-circuit detection, with autostart	16	

- not relevant

### Typical circuits for basic unit 3SK1111 Standard relay

The black fields show the positions of the switches. Here, "Autostart" in each case.

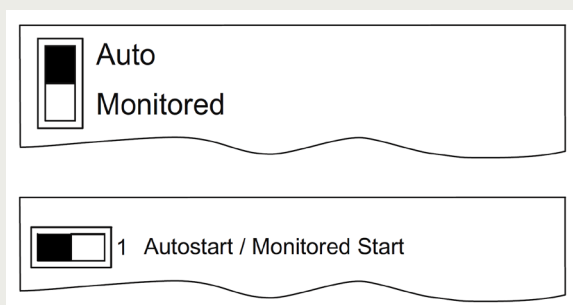



Typical circuit 1: Single-channel, with monitored start

- Monitored start
- 3SK1111 Standard relay
- Sensor: 1 NC contact

Slide switch	
Auto	Monitored
—	ON bottom
Up to PL in accordance with ISO 13849-1	c
Up to Safety Integrity Level (SILCL) to IEC 62061	1

\* For 3SK1111-.AB30 basic unit only

Typical circuit 2: Single-channel, with monitored start

- Monitored start
- 3SK1111 Standard relay
- Sensor: 1 NC contact

Slide switch	
Auto	Monitored
—	ON bottom
Up to PL in accordance with ISO 13849-1	c
Up to Safety Integrity Level (SILCL) to IEC 62061	1

# Typical circuits

Typical circuit 3: single-channel, with autostart

\* For 3SK1111-.AB30 basic unit only

<ul style="list-style-type: none"> <li>Autostart</li> <li>3SK1111 Standard relay</li> <li>Sensor: 1 NC contact</li> </ul>	
Slide switch	
Auto	Monitored
ON top	—
Up to PL in accordance with ISO 13849-1	c
Up to Safety Integrity Level (SILCL) to IEC 62061	1

Typical circuit 4: single-channel, with autostart

<ul style="list-style-type: none"> <li>Autostart</li> <li>3SK1111 Standard relay</li> <li>Sensor: 1 NC contact</li> </ul>	
Slide switch	
Auto	Monitored
ON top	—
Up to PL in accordance with ISO 13849-1	c
Up to Safety Integrity Level (SILCL) to IEC 62061	1

Typical circuit 5: EMERGENCY STOP two-channel, with cross-circuit detection, with monitored start

<ul style="list-style-type: none"> <li>• Monitored start</li> <li>• With cross-circuit detection</li> <li>• Sensor: 2 NC contacts</li> <li>• 3SK1111 Standard relay</li> </ul>	
Slide switch	
Auto	Monitored
—	ON bottom
Up to PL in accordance with ISO 13849-1	e
Up to Safety Integrity Level (SILCL) to IEC 62061	3

\* For 3SK1111-.AB30 basic unit only

Typical circuit 6: Two-channel, with cross-circuit detection, with autostart

<ul style="list-style-type: none"> <li>• Autostart</li> <li>• With cross-circuit detection</li> <li>• Sensor: 2 NC contacts</li> <li>• 3SK1111 Standard relay</li> </ul>	
Slide switch	
Auto	Monitored
ON top	—
Up to PL in accordance with ISO 13849-1	e
Up to Safety Integrity Level (SILCL) to IEC 62061	3

\* For 3SK1111-.AB30 basic unit only

# Typical circuits

Typical circuit 7: Sensors with solid-state outputs, without cross-circuit detection, with autostart

<ul style="list-style-type: none"> <li>Autostart</li> <li>Without cross-circuit detection</li> <li>Sensor: 2-channel non-floating</li> <li>3SK1111 Standard relay</li> </ul>	
Slide switch	
Auto	Monitored
ON top	—
Up to PL in accordance with ISO 13849-1	e
Up to Safety Integrity Level (SILCL) to IEC 62061	3

Typical circuits for 3SK1 Standard solid-state basic units or 3SK1 Advanced basic units

Typical circuit 8: EMERGENCY STOP two-channel, with cross-circuit detection, with monitored start

<ul style="list-style-type: none"> <li>Monitored start</li> <li>With cross-circuit detection</li> <li>1 x two-channel</li> <li>Sensor: 2 NC contacts</li> <li>3SK1112 Standard solid-state and 3SK112 / 3SK122 Advanced</li> </ul>			
DIP switch			
1	2	3	4
ON right	ON right	ON right	—
Up to PL in accordance with ISO 13849-1			e
Up to Safety Integrity Level (SILCL) to IEC 62061			3

Typical circuit 9: Two-channel, with cross-circuit detection, with autostart

- Autostart
- With cross-circuit detection
- 1 x two-channel
- Sensor: 2 NC contacts
- 3SK1112 Standard solid-state and 3SK112 / 3SK122 Advanced

DIP switch			
1	2	3	4
OFF left	ON right	ON right	—
Up to PL in accordance with ISO 13849-1			e
Up to Safety Integrity Level (SILCL) to IEC 62061			3

Typical circuit 10: Electronic sensor, 2-channel, without cross-circuit detection, with monitored start

- Monitored start
- Without cross-circuit detection
- 1 x two-channel
- Sensor: 2-channel non-floating
- 3SK1112 Standard solid-state and 3SK112 Advanced

DIP switch			
1	2	3	4
ON right	OFF left	ON right	—
Up to PL in accordance with ISO 13849-1			e
Up to Safety Integrity Level (SILCL) to IEC 62061			3



# Typical circuits

Typical circuit 11: Electronic sensor, two-channel, without cross-circuit detection, with autostart

- Autostart
- Without cross-circuit detection
- 1 x two-channel
- Sensor: 2-channel non-floating
- 3SK1112 Standard solid-state and 3SK1112 Advanced

DIP switch			
1	2	3	4
OFF left	OFF left	ON right	—
Up to PL in accordance with ISO 13849-1			e
Up to Safety Integrity Level (SILCL) to IEC 62061			3

Note: Single-channel connection - If only one single-channel sensor is used, the other sensor circuit must be jumper

Typical circuit 12: 2 x single-channel, without cross-circuit detection, with monitored start

- Monitored start
- Without cross-circuit detection
- 2 x single-channel
- Sensor: two single-channel NC sensors
- 3SK1112 Standard solid-state and 3SK1112 Advanced

DIP switch			
1	2	3	4
ON right	OFF left	OFF left	—
Up to PL in accordance with ISO 13849-1			c
Up to Safety Integrity Level (SILCL) to IEC 62061			1

Typical circuit 13: 2x single-channel, without cross-circuit detection, with autostart

- Autostart
- Without cross-circuit detection
- 2 x single-channel
- Sensor: two single-channel NC contacts
- 3SK112 Standard solid-state and 3SK112 Advanced

DIP switch			
1	2	3	4
OFF left	OFF left	OFF left	—
Up to PL in accordance with ISO 13849-1			c
Up to Safety Integrity Level (SILCL) to IEC 62061			1

Typical circuits for 3SK1 Advanced basic units only

Typical circuit 14: 1NC/1NO sensor, with cross-circuit detection, with monitored start

- Monitored start
- With cross-circuit detection
- 1 x two-channel
- Jumper T1/PAR for NC/NO evaluation
- Sensor: NC/NO sensor
- 3SK112 Advanced

DIP switch			
1	2	3	4
ON right	ON right	ON right	—
Up to PL in accordance with ISO 13849-1			e
Up to Safety Integrity Level (SILCL) to IEC 61508			3

# Typical circuits

15 Typical circuit 15: 1NC/1NO sensor, with cross-circuit detection, with autostart

- Autostart
- With cross-circuit detection
- 1 x two-channel
- Jumper T1/PAR for NC/NO evaluation
- Sensor: NC/NO sensor
- 3SK112 Advanced

DIP switch			
1	2	3	4
OFF left	ON right	ON right	—
PL in accordance with ISO 13849-1			e
Safety Integrity Level (SILCL) to IEC 61508			3

16 Typical circuit 16: Two-hand operation, with cross-circuit detection, with autostart

- Autostart
- With cross-circuit detection
- 2 x single-channel
- Jumper T1/PAR for NC/NO evaluation
- Sensor: Two-hand NO/NO sensor
- 3SK112 Advanced

DIP switch			
1	2	3	4
OFF left	ON right	OFF left	—
PL in accordance with ISO 13849-1			e
Safety Integrity Level (SILCL) to IEC 61508			3

# Safety is a SIRIUS business: More than just evaluation

The products of the SIRIUS Safety portfolio are part of Safety Integrated. The resulting advantage for users is enormous, because everything fits together here.

## Products

ET 200SP motor starter:  
**Switching motors – safety integrated**

The SIMATIC ET 200SP decentralized I/O system stands for innovative and highly flexible switch-gear control. With the Safety variant of the ET 200SP motor starter up to 5.5 kW, safety is always integrated. Whether controlling or switching, starting or monitoring, you can rely on ET 200SP. Thanks to its high-performance and compact design, you save even more space in the control cabinet and benefit from versatile functionality in the control of your system.

Find out more



3SE position and safety switches  
**Detecting hazards – absolutely reliably**

SIRIUS sensing devices precisely detect motion sequences around machines and systems in almost any application. Whether for position detection, motion limitation of certain machine parts, or in safety circuits: Our sensing devices have command over the large variety of information in the field, even under the harshest conditions. For seamless monitoring, we also offer a comprehensive range of non-contact sensors.

Find out more



SIRIUS ACT with PROFINET  
**Connecting an emergency stop to the control system – more efficient than ever before**

When it comes to communication, SIRIUS ACT performs exceptionally: In addition to the standard wiring, you can also connect the command and signaling devices (e.g., the emergency stop control device) directly to the control system – in the field or control cabinet, via PROFINET or PROFIsafe. This reduces your wiring effort, thus minimizing sources of error. In addition, you gain more flexibility when it comes to changes.

Find out more



3TK2810 speed and standstill monitors  
**Monitoring motors**

SIRIUS 3TK2810 carries out continuous standstill and speed monitoring in machines and systems. Using simple parameterization and constant diagnostics, troubleshooting can be carried out quickly at any time – often before any associated system standstill has occurred.

Find out more



## Services & Support

Safety Evaluation Tool  
**Checking safety engineering – online**

The Safety Evaluation Tool for standards IEC 62061 and ISO 13849-1 takes you directly to your goal. This TÜV-approved online tool helps you to quickly and reliably evaluate the safety functions of your machine.

Find out more



Training  
**Continuing education – from trainers with first-hand knowledge**

Siemens offers you a comprehensive range of training courses – from basic knowledge to expert know-how in functional safety.

Find out more



Safety application manual  
S.I.A.M.  
**Know-how for building applications**

Using simple wiring examples, S.I.A.M. provides you with insight into the fundamental safety requirements in the production industry.

Find out more



# Functional Safety

Safety Lifecycle Services for the Manufacturing Industry\*

## Our support

At Siemens we offer you an effective means right from the start of preventing faults inherent in processes and of keeping an efficient, verified record of functional & operational safety. Through inspections, documentation, consulting and defining remedial measures, we assist you in meeting the current safety requirements most effectively.

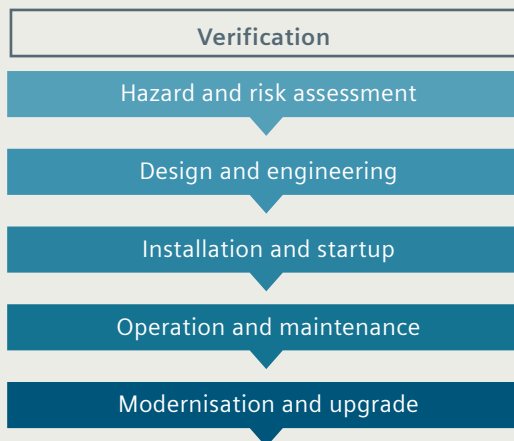

## Support from Design to Upgrade

At Siemens we know the topic of functional safety involves much more than just installing SIL certified hardware and software components. It requires expert knowledge that is up-to-date with the latest technologies, standards and guidelines:

- Before creating a machine, the machine manufacturer carries out a risk analysis while observing all of the relevant standards. This shows what risks the machine poses and how they must be countered
- The risk analysis reveals which components are needed for making the hazardous zones safe. The safety must be verified so that the machine receives its CE marking
- The operator must observe the occupational health & safety guidelines – as well as the documentation for following the machinery directive (supply of machinery safety regulations) that the machine manufacturer must produce
- If maintenance is required, it must be performed quickly in order to keep downtimes and standstills as short as possible. If a fault does occur, it must be eliminated as soon as possible or with only the shortest possible interruptions
- In order to bring existing plants up to the state of the art of safety engineering, expansion or modernisation measures are necessary

## Our Range of Services

- Management and assessment of functional safety and audits
- Planning and design of the SLC (safety plan)
- Hazard and risk assessment (EN ISO 12100)
- SIL /PL assessments
- Safety Requirements Specification (SRS)
- Support in planning and design of controls
- Assessment of safety logic programming against best practice
- Verification (e.g. SIL verification, H/W & S/W audit)

## Benefits

- Standardised processes for faster and safer project implementation and commissioning
- Comprehensive package of services from risk identification and verification to plant start-up and modernisation.
- Uniform verification and validation documentation
- Independent competent team
- Detailed safety application examples

\*For more information contact us at [safetyintegrated.uk.gb@siemens.com](mailto:safetyintegrated.uk.gb@siemens.com)

Safer Plants are more Profitable Plants\*

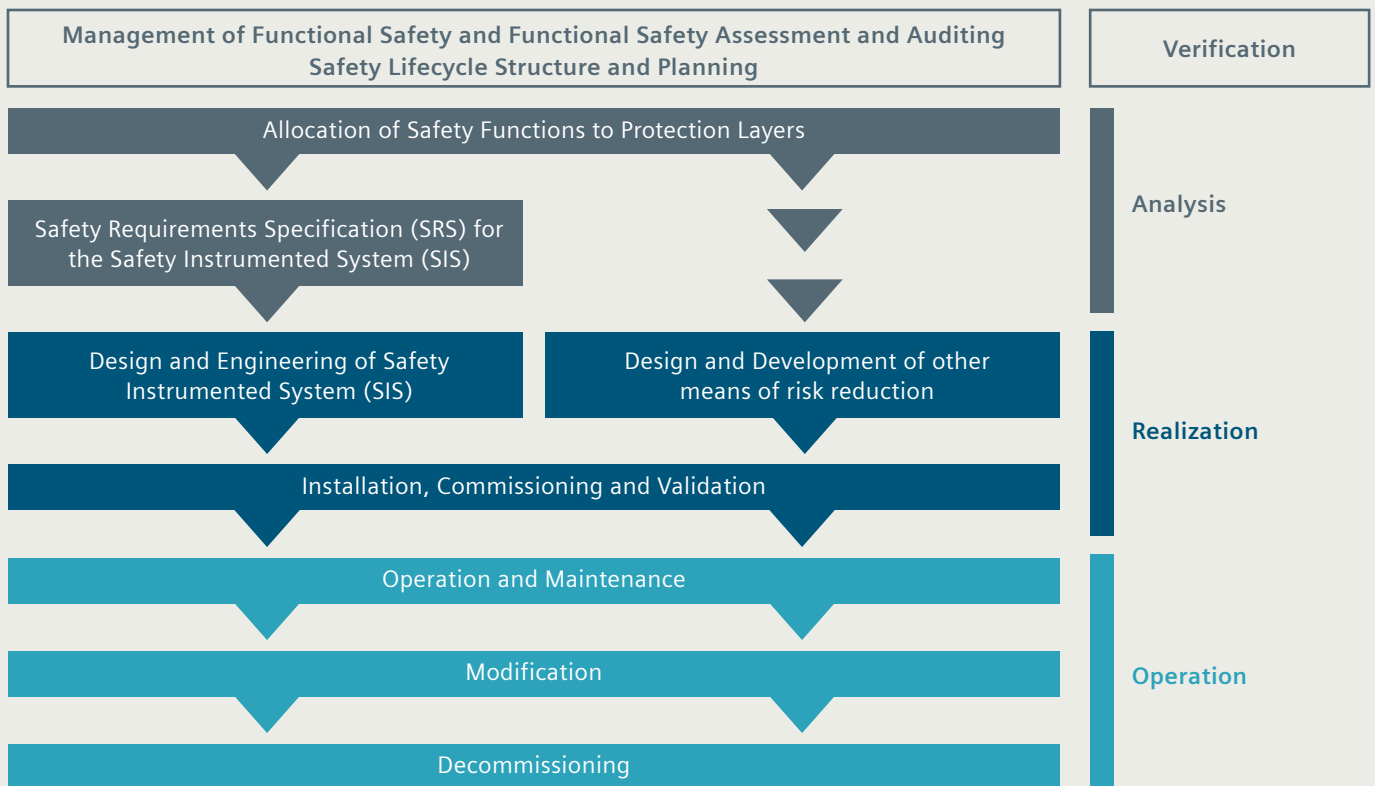

At Siemens, we recognise that Functional safety is about more than just installing SIL-certified hardware and software components. It requires expert knowledge that is up-to-date with the latest technologies, standards and guidelines.

Plant operators who use Safety Instrumented Systems (SIS) to help reduce risk – including chemical plants, refineries and combustion facilities – must implement a system for the management of functional safety, to ensure that they have reduced risk to an acceptable level.

We understand the importance of effective Functional Safety Management (FSM). By ensuring that all Safety Lifecycle phases are properly planned, undertaken and verified we can be certain that the desired safety integrity level (SIL) targets are met. We can provide a range of services to help you implement a functional safety management system or to identify and address gaps in your existing systems. We can also provide additional technical expertise to help identify hazards, analyse risk and assess SIL requirements.

## Our Range of Services

- Management and assessment of functional safety and audits
- Planning and design of the Safety Lifecycle (safety planning)
- Hazard and safety assessment facilitation (HAZID, HAZOP)
- Allocation of safety functions to protection layers
- SIL Assessments (Risk Graph, LOPA)
- Safety Requirement Specifications (SRS)

## Benefits

- Standardised processes for faster and safer project implementation and commissioning
- Uniform verification and validation documentation
- Interdisciplinary team of experts with process and automation know-how leading to reduced development time and costs.
- Tailor-made safety concepts giving accelerated plant acceptance

Errors which are not identified in the early stages of a project are often very complex and expensive to correct later on. We can help you avoid systematic errors in all project phases with our standardised engineering guidelines and verification templates.

\*For more information contact us at [safetyintegrated.uk.gb@siemens.com](mailto:safetyintegrated.uk.gb@siemens.com)



# Failsafe products

## AS-interface - ASIsafe machine safety\*



### AS-interface: Simple, safe and uniform

- Industrial communication with the AS interface field bus IO system
- Waterproof system solutions (IP65/67)
- Easy assembly
- Failsafe technology integrating seamlessly up to PL e/ SIL 3 / Cat.4

Designs and comprehensive technical information about AS interface and ASIsafe can be found:

- In the Industrial Communication catalogue: IKPI 2015, section 6
- In the Safety Integrated catalogue: SI 10 2014
- On the internet: [www.siemens.nl/AS-interface](http://www.siemens.nl/AS-interface)

## Failsafe motor management system\*

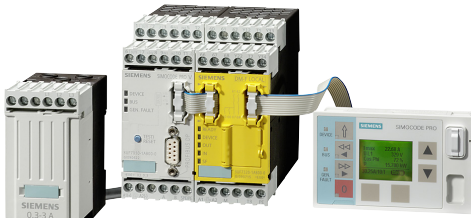

### SIMOCODE-pro V 3UF7: Complete motor management system with integrated failsafe technology

- Motor control
- Thermal overload protection
- Integration of failsafe technology for safe motor disconnection up to PL e / SIL 3 / Cat.4

Designs and comprehensive technical information about SIMOCODE can be found:

- In the Industrial Control catalogue: IC 10 2021

## SIMATIC failsafe controllers\*



### SIMATIC automation system with integrated failsafe technology:

- Standard and failsafe automation in one PLC up to PL e/ SIL 3
- Failsafe HMI panels
- Failsafe communication, even via WLAN
- Use of open-standard field buses PROFIBUS and PROFINET

Designs and comprehensive technical information can be found:

- In the Safety Integrated catalogue: SI 10 2014

## SINAMICS failsafe drives\*



### SINAMICS drive technology with integrated failsafe functionality

- Failsafe functionality fully integrated in drive up to PL d/ SIL 2
- Sensorless/encoderless measuring principle
- Single or multi-axis control
- Use of open-standard field buses PROFIBUS and PROFINET

Designs and comprehensive technical information can be found:

- In the Safety Integrated catalogue: SI 10 2014

\*For the latest information, visit the Industry Mall: [www.siemens.com/industrymall/gb](http://www.siemens.com/industrymall/gb)

# Safety tool, functional examples & B10 values

## Safety Evaluation Tool: Safe machine concepts without detours

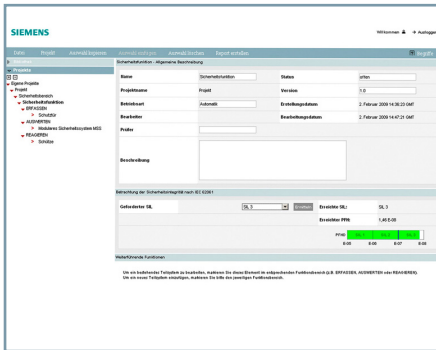

## Safety Evaluation Tool: Online SIL (EN 62061) and PL (EN ISO 13849) calculation for safety functions

The free Safety Evaluation Tool (SET) for the IEC 62061 and ISO 13849-1 standards gets you directly to your goal. This online tool supports the fast and reliable assessment of your machine's safety functions. As a result, you are provided with a standard-compliant report that can be integrated in the machine documentation as a proof of safety. Simply download the TIA selection tool using the link below, in the tool simply choose to add new device and select safety evaluation.

For more information, or to get going immediately with the Safety Evaluation

## Functional connection examples for machine safety applications (Functional Examples)

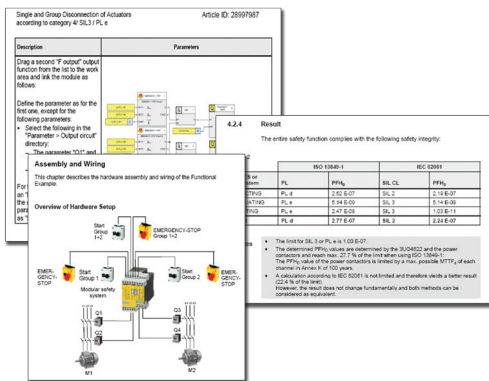

## Siemens makes designing easy with fully worked-out examples of machine safety applications

The Functional Examples comprise of:

- Description of the safety function
- Hardware structure and software program
- Connection diagrams
- Fully worked-out and motivated SIL and PL calculations of the safety function.

For further functional connection examples (downloadable) please visit our machine safety website: [www.siemens.com/safety](http://www.siemens.com/safety) and look under 'Functional Examples'.

## B10 values of SIRIUS components

Comprehensive information about machine safety standards can be found in the brochure: "Functional safety of machines and production plants - Simple implementation of the European Machine Directive". For more information about standards, you can also visit our special site for machine safety: [www.siemens.com/safety](http://www.siemens.com/safety)

### SIRIUS – standard B10 values of electromechanical components

Electromechanical components are subject to wear and tear. The risk of failure of electromechanical components can be calculated with the B10 value and the operating cycle. The B10 value is expressed in the number of switching cycles. This is the number of switching cycles during which 10% of the specimens failed during a durability test.

In accordance with ISO 13849-2 (annex D), ISO/FDIS13849-1:2005 (annex C) and EN62061 (annex D, failure rates of electrical/electromechanical components) the B10 values must be defined for electromechanical components.

Siemens SIRIUS product group Electromechanical components)	Normal B10 values (switching cycles)	Percentage dangerous failure	
Emergency stop switches (with mechanically forced break contacts)	Turn to unlatch	100,000	20%
	Pull to unlatch	30,000	20%
Cable-operated switches for emergency stop function (with mechanically forced break contacts)		1,000,000	20%
Standard position switches (with mechanically forced break contacts)		10,000,000	20%
Position switches with separate actuator/key switch (with mechanically forced break contacts)		1,000,000	20%
Position switches with electromagnetic locking (with mechanically forced break contacts)		1,000,000	20%
Hinge switches (with mechanically forced break contacts)		1,000,000	20%
Pushbutton switches (with mechanically forced break contacts)		10,000,000	20%
Contactors/motor starters (with mechanically linked or mirrored contacts)		1,000,000	20%

**Siemens plc**  
Smart Infrastructure  
Sir William Siemens House  
Princess Road  
Manchester  
M20 2UR

© Siemens plc 2022

The information provided in this brochure contains merely general descriptions or characteristics of performance which in actual case of use do not always apply as described or which may change as a result of further development of the products. An obligation to provide the respective characteristics shall only exist if expressly agreed in the terms of contract.

All product designations may be trademarks or product names of Siemens AG or supplier companies whose use by third parties for their own purposes could violate the rights of the owners.

ZST 0122