

Installation Instructions

	⚠ DANGER
	Hazardous Voltage. Will cause death or severe injury.
	Turn off and lock out all power supplying this device before removing cover(s) or device and while cover(s) are removed.
	Wire connector shield no. NDTs must be installed when wire connectors TA2K8750, TA3P8750, TA4P8500, TA2N8750, TA3N8750, OR TA4N8500 ARE USED. Replace all covers and shields before power supplying this device is turned on.

NOTE: Accessory installation should be complete before the circuit breaker is mounted and connected. (See installation instructions supplied with the Accessory before proceeding.)

C. Depress the red trip button (See Fig. 4) or turn the breaker off before installation.

D. To mount the device, perform the following steps:

1. For enclosures, panelboards and switch boards manufactured by Siemens Energy & Automation, Inc., follow instructions provided with the equipment.



SAFETY INSTRUCTIONS

NOTE: This instruction outlines the recommended installation procedure.

Introduction

The MD and ND Frame circuit breaker line includes SMD6, SHMD6, SCMD6(-A), SND6, SHND6 and SCND6(-A) circuit breaker types. These devices are rated for operating voltages up to 600 VAC, 50/60 Hz.

Installation

The MD and ND Frame circuit breaker devices are for use in individual enclosures, panelboards or other approved equipment.

The installation procedure consists of inspecting, attaching required accessories, mounting the device and connecting and torquing the line and load wire connectors.

Mounted hardware and unmounted wire connectors (where required) are available as separate catalog items.

Circuit Breaker Preparation

- A. Before installing or servicing the breaker, turn off and lock out all power to prevent incidental or accidental contact.
- B. Make sure that the device is suitable for the installation by comparing nameplate ratings with system requirements. Inspect the device for completeness and check for any damage before mounting.

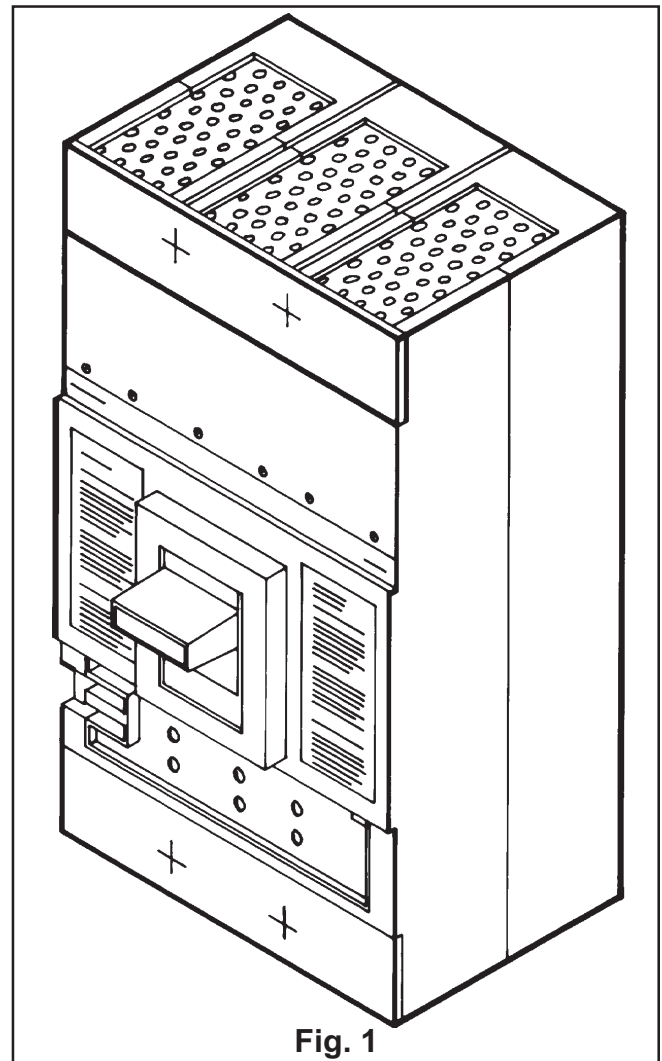
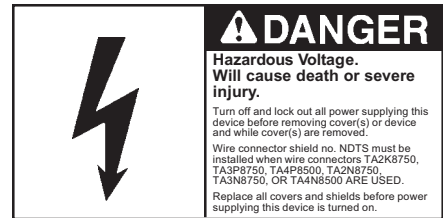

Fig. 1



Installation Instructions

2. For applications where mounting is on a flat surface of the equipment, drill and tap mounting bolt holes as shown in Fig. 2. For handle escutcheon cutout, refer to Fig. 3.
3. Ensure that any internal breaker accessory terminals can be properly connected with the circuit breaker in the mounted position.
4. Position the circuit breaker in the mounting location, install the mounting hardware and tighten securely.
5. Connect the line and load terminals and torque using the values shown on the circuit breaker nameplate.
6. Connect all accessory terminals, if present.
7. Check all mounting hardware for secureness. Check wire connectors for correct torque requirements.

Manual Operation

Manual operation of the device is controlled by the circuit breaker handle and the PUSH-TO-TRIP button. The device handle has three indicating positions, two of which are molded into the handle to indicate ON and OFF. The third position indicates a TRIP position and is between ON and OFF positions. (See Fig. 4)

- A. Device Reset
 After tripping, the device is reset by moving the device handle to the reset position and then moving the handle to the ON position.
- B. The PUSH-TO-TRIP Button
 The PUSH-TO-TRIP button checks the tripping function and is used to manually exercise the operating mechanism.

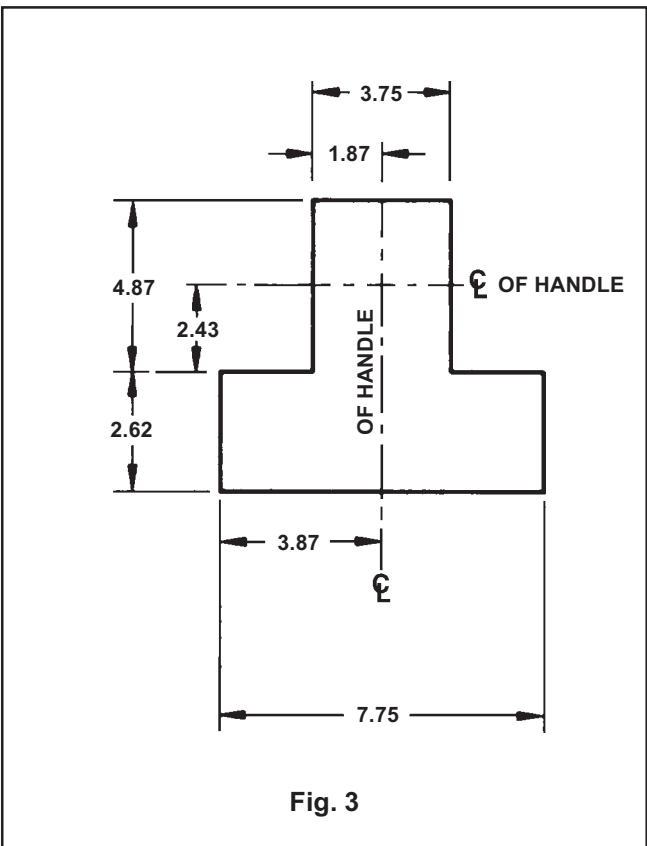
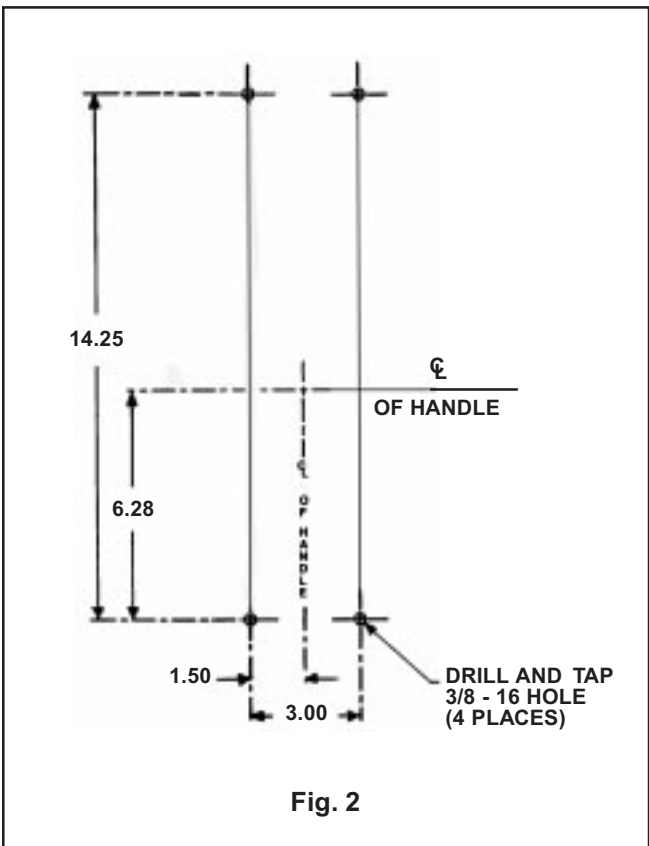

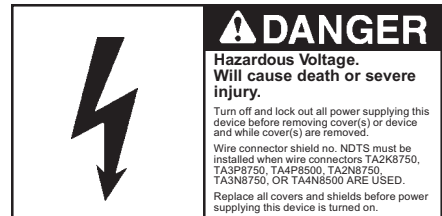

Installation Instructions

Inspection and Field Test

MD and ND Frame devices are designed to provide years of maintenance free service. Sensitrip III Solid State Molded Case circuit breakers may be tested for electronic functionality by the use of TS-31 test set available from local Siemens sales offices.

Maintenance

Experience has shown that properly applied molded case circuit breakers normally do not require main-

tenance. However, some industrial users may choose to establish an inspection and maintenance procedure to be carried out on a regular basis. For detailed information, consult applicable NEMA publications or your local Siemens sales office.

NOTE: Do not spray or allow any petroleum based chemicals, solvents or paints to contact the molded parts or nameplates.

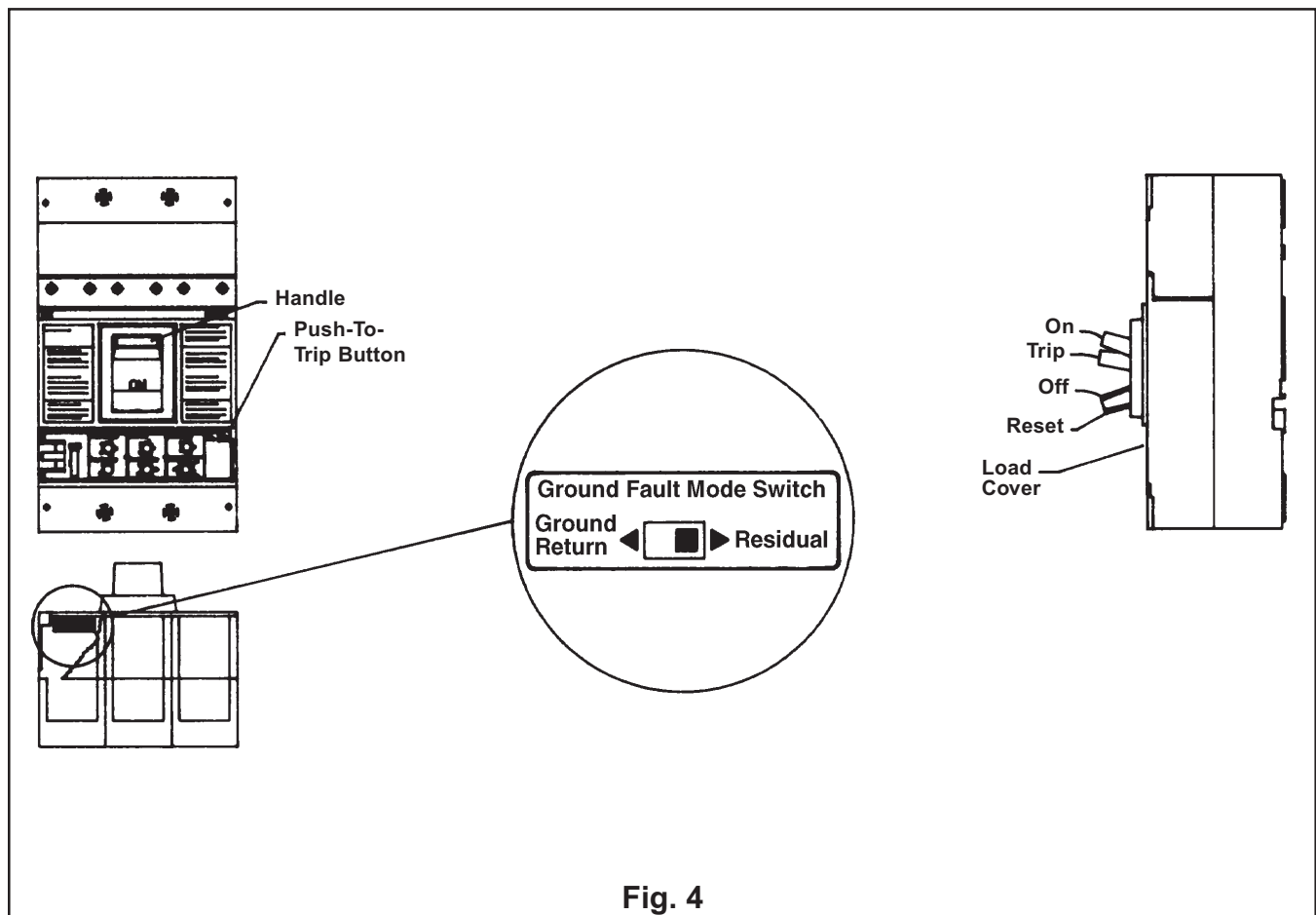

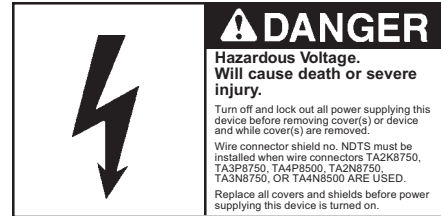

Installation Instructions

ELECTRONIC OPERATION

The setting dials on the face of the electronic trip unit are rotary switches that must be properly set to mechanical detent (click stop) positions. An improper switch setting will cause the trip unit to default (as a fail safe condition) to the lowest permissive setting and, consequently, may result in unintentional or nuisance tripping.

Continuous Current Switch $I_r = \%I_n$

Adjustments made to this switch can change the continuous amps rating of the breaker to 20, 30, 40, 50, 60, 70, 80, 90 or 100% of the maximum continuous amps rating (I_n) of the circuit breaker. The diagram below shows the settings possible on this switch.

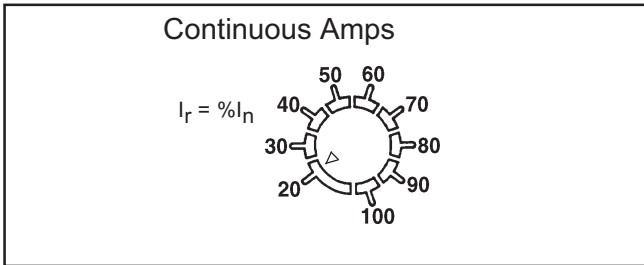

Long Time Delay @ $6xI_r$

The adjustable long time delay switch allows for selection of long time delays based on I^2t curves at six times the continuous amps setting (I_r). The diagram below illustrates the possible settings for this switch.

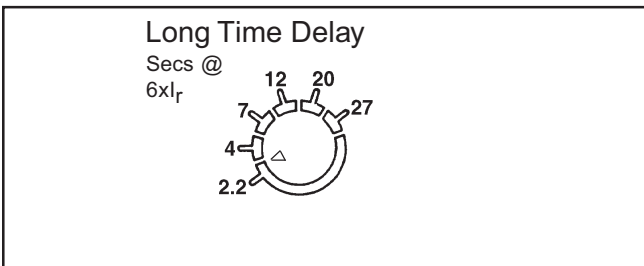

Short Time Pickup xI_r (optional)

Circuit breakers with the letters "NT" in the catalog number have adjustments to set the Short Time Pickup and the Short Time Delay.

The adjustable short time pickup switch allows for selection of short time pickup in a range from 1.5 to 10 times the setting of the Adjustable Continuous Amps Switch. The OFF position disables the function. The diagram below illustrates the possible settings for this switch.

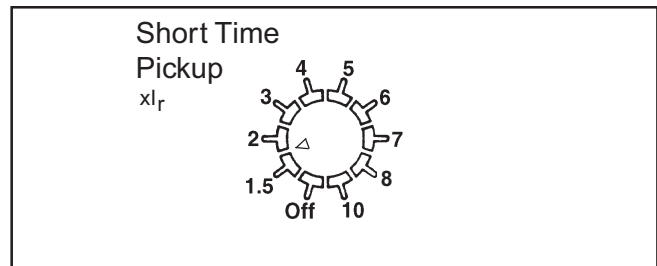

Short Time Delay (optional)

The adjustable short time delay switch allows for selection from two ranges of short time delays. The first range of settings enable the breaker to be set for fixed time delays of .05, .1, .2, .3, or .5 seconds. The second range of settings enable the breaker to be set for short time delays based on I^2t curves at six times the continuous amps setting. The diagram below illustrates the possible settings for this switch.

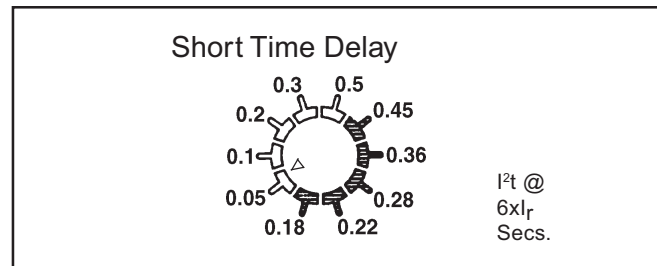

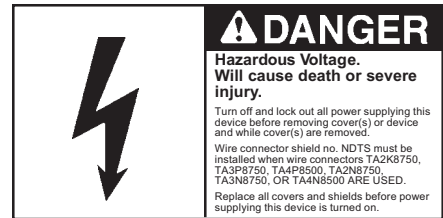

Installation Instructions

Instantaneous Trip Switch xI_r

The adjustable instantaneous trip switch allows selection of a tripping point from 2 to 40 times the ampere rating. The MAX setting sets the instantaneous pickup to the override level (see note below). The diagram below illustrates the possible settings for this switch.

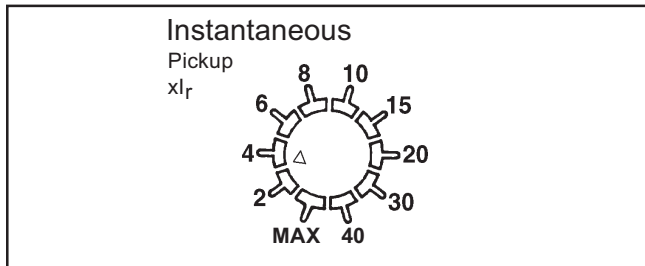

NOTE: Breaker contains an override at multiples of the maximum continuous current rating. These multiples are 12.5 times for 600A - 800A breakers. Ten (10) times for 1000A breakers and 8 times for 1200A breakers. Above these levels, the short time delay is no longer operational, and the breaker will trip instantaneously.

Adjustable Ground Fault (optional)

Pickup $I_g = \% I_n$
 Delay $I^2t @ .5 I_n$

Circuit breakers with the letter "G" included in the catalog number have integral equipment ground fault protection. These circuit breakers have an adjustment to set the Ground Fault Pickup current (I_g) as a percentage of the Maximum Continuous Current rating (I_n).

The pickup has a built in time delay. Three time delays are available of 0.1, 0.2 or 0.4 seconds. These are selected by using the appropriate area of the setting. Below 50% Maximum Continuous Current rating (I_n), the pickup delay has an I^2t slope.

The adjustable ground fault pickup and delay switch allows for the selection of ground fault pickup at various percentages of the maximum ampere rating ($\% I_n$), with an I^2t delay @ $.5x I_n$ of .1, .2, or .4 seconds. The diagram below illustrates the possible settings for this switch.

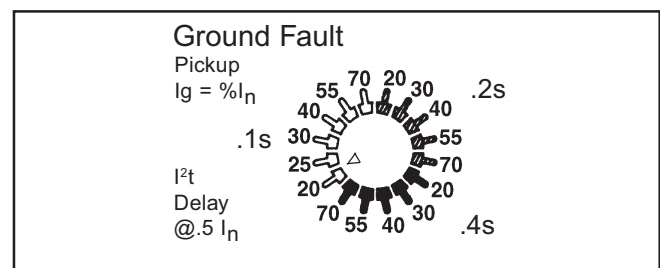

The ground fault option has two modes of operation. The mode is set by a switch on the bottom of the trip unit with the settings identified as RESIDUAL and GROUND RETURN. See Fig. 4 for switch location.

RESIDUAL MODE (OUTGOING CIRCUIT METHOD) — This is the standard position that the breaker is set to when shipped from the factory. With the switch in this position, the circuit breaker may be used on 3 phase 3 wire or, with the addition of an external neutral sensing transformer, on 3 phase 4 wire systems.

GROUND RETURN SETTING (GROUND RETURN METHOD) — This setting may only be used for service disconnects or separately derived systems. With the switch in this position, the circuit breaker may be used on 3 phase 3 wire and 3 phase 4 wire systems. An external sensing transformer, which is installed on the main bonding jumper, is required for this method. See Neutral Sensing Transformer section for more information.

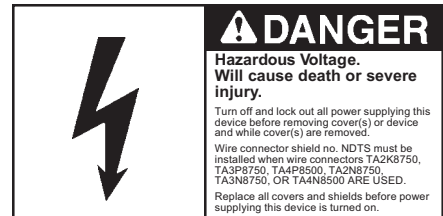

Installation Instructions

Neutral Sensing Transformer.

An external transformer is required for circuit breakers equipped with ground fault protection when operating in the RESIDUAL mode on 3 phase 4 wire systems and when operating in the GROUND RETURN mode on any system. The sensors listed below must be used for these applications. The sensor catalog number must be matched to the circuit breaker Maximum Continuous Current rating (I_n) as shown in the table. Please note that sensors used with other breaker types cannot be used with the SMD/SND circuit breakers. Installation instructions are included with the sensors.

Transformer Catalog No.	Circuit Breaker Rating	Transformer Color
N06SMDA	600 Amps	GREEN
N07SMDA	700 Amps	GREEN
N08SMDA	800 Amps	GREEN
N10SNDA	1000 Amps	GREEN
N12SNDA	1200 Amps	GREEN

Electronic Testing

Senstrip III solid state molded case circuit breakers may be tested for electronic functionality by the use of a TS-31 test set available from local Siemens sales offices.

NOTE: Time current characteristic curves and information on factory installed accessories can be obtained from local Siemens sales offices.

This product is covered by the following patent: 4,631,525.