

WinCC RT Professional V16 Architectures

The SCADA system inside TIA Portal – Efficiency and transparency for your plant

WinCC RT Professional V16 architectures

Legend

SIEMENS
Ingenuity for life

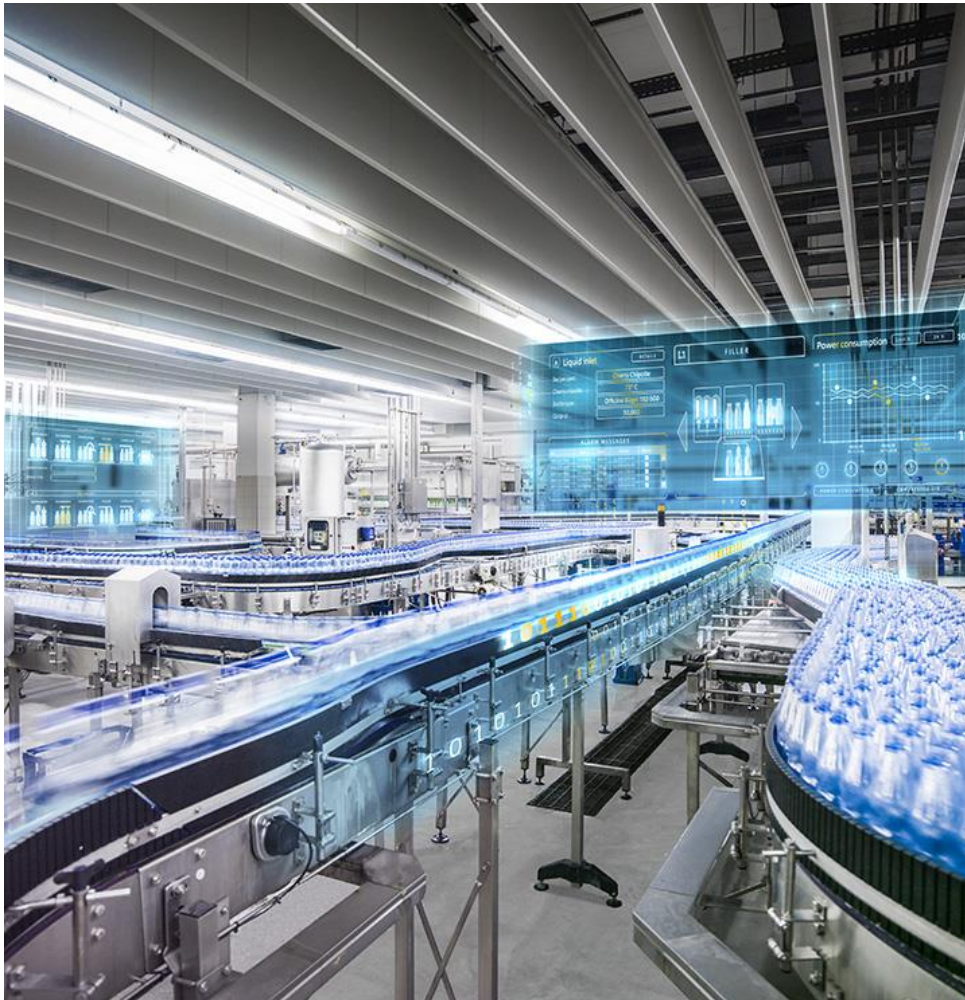

- WinCC Runtime Professional V16
Base Packages = Base Package
- SIMATIC Information Server 2014 SP3 upd4 = IS2014
- SIMATIC Process Historian 2014 SP3 upd4 = PH2014

WinCC RT Professional V16

Basic functionality

Basic functionality	Description
WinCC / OPC-Server	<ul style="list-style-type: none">• The WinCC OPC servers provide customer-specific OPC clients with data from the WinCC data warehouse, e.g. process values or messages.• The WinCC OPC UA server is installed as Windows service and started automatically. The WinCC OPC UA server supports only the communication profile "UA-TCP UA-SC UA Binary". The used port number is adjustable.• WinCC OPC HDA Server The WinCC OPC HDA Server enables an OPC HDA Client to access the archived process values in the WinCC archive system.
Runtime API	<ul style="list-style-type: none">• Runtime API describes the open programming interface of WinCC.• Via the API functions, you use the internal functions of WinCC in your own applications and access HMI tag data or data in the archives <p><u>Application</u></p> <ul style="list-style-type: none">• API functions are used in the following places:• Within WinCC: In user-defined C -functions and local C-scripts.• Outside of WinCC: In Windows applications created in the C/C++ programming language. To use Runtime API in the C# or VB.Net programming languages, you must program a corresponding implementation.

WinCC RT Professional V16

Runtime options

Runtime Options	Description	
WinCC Server / WinCC Client	Server/client systems	Server Lizenz: 6AV2107-0EB00-0BB0 Client-Lizenz: 6AV2107-0DB06-0AH0
WinCC Recipes	Organization of data records for associated machines / production data	6AV2107-0JB00-0BB0
SIMATIC WinCC Redundancy	WinCC Redundancy provides a considerable increase in the availability of WinCC and the system as a whole by operating two servers at the same time linked together.	6AV2107-0FB00-0BB0
WinCC Logging (1500/5000 Tags)	Archiving of process data (including 500 archive tags)	6AV2107-0GB00-0BB0
WinCC WebNavigator	Control and monitoring via the web (MS Internet Explorer)	See WebNavigator slides
WebUX	Platform and browser-independent operator control and monitoring via the web (HTML5)	See WebUX slides
WinCC DataMonitor	Monitoring and analyzing of current and historical process data via the web (MS IE) For new systems, the information server is recommended	
SIMATIC Information Server 2014 SP3 upd4	Web-based analysis and historical process data reports (browser dependent)	
SIMATIC Process Historian 2014 SP3 upd4	Plant-wide archive for messages and process data	
Industrial Data Bridge¹⁾	Configurable connections to databases and IT systems	
SIMATIC ProDiag	SIMATIC ProDiag allows selective and fast machine and plant diagnostics for SIMATIC S7-1500 and SIMATIC HMI:	6AV2107-0UB00-0BB0

WinCC RT Professional V16 Engineering Options



Engineering Options	Description	
SIMATIC EnergySuite (incl. 10 Energy Objects)	Transparency of energy consumption <ul style="list-style-type: none"> • SIMATIC Energy Suite Engineering • SIMATIC Energy Suite S7-1500, 5-100 Energy Objects 	6AV2108-0AA06-0AA5
SIMATIC Visualization Architect	SIMATIC Visualization Architect (SiVArc) enables simple, fast, and flexible automated creation of HMI contents based on the STEP 7 user program.	6AV2107-0PX06-0AA5
MultiUser	TIA Portal Multiuser Engineering allows several users to work on the same project simultaneously.	6ES7823-1AA06-0YA5
TIA Portal Teamcenter Gateway	The TIA Portal Teamcenter Gateway permits storage and management of TIA Portal projects and global libraries in Teamcenter.	6ES7823-1EA06-0YA5
TIA Portal Cloud Connector	The TIA Portal Cloud Connector enables access to local PC interfaces and connected SIMATIC hardware in the TIA Portal Engineering even though the engineering itself takes place via remote desktop in a private cloud.	6ES7823-1CA00-0YA0
SIMATIC ODK 1500S	The SIMATIC ODK 1500S allows the development of function libraries with the high-level languages C/C++ for ODK-capable SIMATIC S7-1500 PLCs.	6AV2108-0AA06-0AA5
SIMATIC Target 1500S TM for Simulink®	The SIMATIC Target 1500S TM for Simulink® is an add-on for Simulink from MathWorks. It allows the integration of Simulink models directly into the program cycle of an ODK-capable S7-1500 PLC.	6AV2107-0PX06-0AA5

SIMATIC WinCC Professional

WinCC Premium Add-ons for Process Management



Efficient data management	Data consistency over the entire production process
PM-CONTROL	Flexible parameter management and job control
PM-QUALITY	Batch-based archiving and reporting
Diagnostic management	Higher availability of machines and production plants
PM-MAINT	Intelligent maintenance management system
PM-ANALYZE	Efficient identification of weak points in the process + reporting
Open-mindedness	Consolidation of automation and IT world
PM-OPEN-EXPORT	Automatic export of process data
PM-OPEN-IMPORT	Automatic import of messages and archive values
PM-LOGON	Automatic registration, e.g.: via RFID

[siemens.com/process-management](https://www.siemens.com/process-management)

\\ww004.siemens.net\bu01\$\NbgM\PROJ\PROMOTOREN_VM\VM_WARE_WORLD_WITHOUT_UCL\Inst_SW\2019_01_Install_PM_AddOn

Analysis + Reporting with PM-ANALYZE



Archiving, Display and analysis of alarms from several different systems in chronological order

- SIMATIC WinCCV7
- PCS7
- WinCC Comfort / RT Professional
- WinCC Advanced
- WinCC flexible
- Event log of the operating system

- Database and archiving
- Manual input values
- Reporting with Microsoft Excel
- Automatic report generation
- Add-in for Microsoft Excel 2007, 2010, 2013, 2016
 - Access to all process value and summarization archives
 - Access to calculated values and key figures
 - Access to messages and operating actions

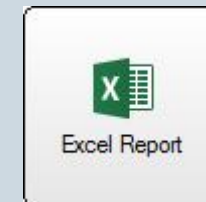

WinCC RT Professional V16

Explanation of symbols



WinCC Single-User System



WinCC Server

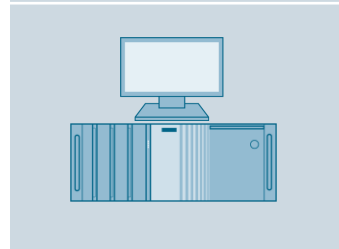

WinCC Standard Client



PC without WinCC

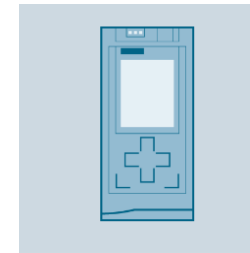

S7 System Components

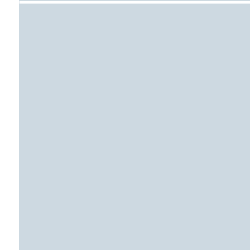

External Database
e.g.: SQL, Oracle, Access

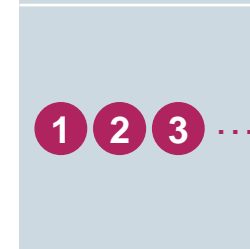

Software to be installed on the computer

WinCC RT Professional V16

System requirements for supported Operating Systems

- Windows 10 64bit Pro
 - Version 1809 (OS Build 17763)
 - Version 1903 (OS Build 18362)
- Windows 10 64bit Enterprise
 - Version 1809 (OS Build 17763)
 - Version 1903
- Windows 10 64bit IoT Enterprise LTSB
 - 2015 LTSP (OS Build 10240) (Test for IPC)
 - 2016 LTSP (OS Build 14393) (Test for IPC)
 - 2019 LTSP (OS Build 17763) (Test for IPC)
- Windows Server 2012 R2 64bit StdE
- Windows Server 2016 64Bit Standard
- Windows Server 2019 64Bit Standard

Office

- Excel 2016
 - Build 16.0.6769 (32 or 64 Bit)
 - Access to Online Office 365

+ Operating Systems



¹⁾ The Windows operating system is only released together with a SIMATIC IPC.

WinCC RT Professional V16 Browser

Microsoft Browser:

- Google Chrome*
- Microsoft Edge
- Mozilla Firefox, Mozilla Firefox ESR



Android Browser:

- Google Chrome*
- Firefox
- Edge



iOS & Mac Browser:

- Safari*
- Google Chrome
- Firefox
- Edge



* Browser with the main focus for this operating system

WinCC RT Professional V16

Supported virtualization software



WinCC Engineering and Runtime

- WinCC Professional V16 & WinCC Runtime Professional V16 are released for the following virtualization platforms

Virtualization platforms	Engineering	Runtime Advanced/ Professional
VMware vSphere Hypervisor (ESXi) ab, 6.5 or higher	✓	✓
VMware Workstation 12.5.5 / 15.0.2	✓	✗
VMware Player 12.5.5/ 15.0.2	✓	✗
Microsoft Windows Hyper-V Server 2016 or 2019	✓	✓

All of the released operating systems can be used as host operating systems in a virtualization platform.

WinCC RT Professional V16

Compatibility and general information (continued)

Side-by-side installation with all SIMATIC products

Parallel installation von WinCC Runtime Professional V16 and other SIMATIC HMI Products

The parallel installation of WinCC V16 with versions of WinCC flexible before WinCC flexible 2008 SP5 is not permitted.

The parallel installation of WinCC V16 with WinCC V7 is not permitted for:

- WinCC V16 Professional
- WinCC V16 Runtime Professional

Parallel Use

If the software or license key after the installation is named with the affix "Combo", the use of the following products/versions is permitted:

- With license "STEP 7 Professional Combo": older versions of STEP 7 (STEP 7 Professional 2006 – STEP 7 Professional V16)
- With license "WinCC V16 Comfort Combo": WinCC flexible 2008 Standard
- With license "WinCC V16 Advanced Combo": WinCC flexible 2008 Advanced

WinCC RT Professional V16

Compatibility and general information (continued)

Remote-Software → [Link](#)

The following options are available for remote access to WinCC stations:

- NC (Real VNC) Enterprise Edition V5.0.1.
- RDP (Remote Desktop Protocol)

The RealVNC software must be used for remote access to the other computers of a distributed WinCC system (e.g. WinCC Server).

The Remote Desktop Protocol (RDP) may only be used for remote maintenance of WinCC clients.

Furthermore, no server services (e.g. WebNavigator server, DataMonitor server, OPC server) may be active on these computers. The reason for this is the handling of the remote desktop sessions by the Microsoft operating system.

WinCC running in service mode

The service mode allows you to run WinCC Runtime Professional as a service.

WinCC Runtime Professional can also be active as a service if no interactive user is logged on to the computer.

WinCC RT Professional V16

Compatibility and general information (continued)

Remote Software: Using RealVNC → [Link](#)

The following scenarios were tested:

- WinCC as a single-user system
- WinCC as a distributed system
- WinCC in redundant operation
- WinCC/WebUX Server

You can also use communication via OPC in the released scenarios.

Start Remote Desktop

Access to WinCC systems with a Remote Desktop Client is only possible via a console session.

Access via the Remote Desktop Protocol may only take place via console transfer with the same user or initial logon.

SIMATIC WinCC RT Professional Upgrade for Power Tags at WinCC in TIA Portal (to V16)



... WinCC RT Professional V11... → V16		RT SUS (V16)
WinCC RT Professional RT Client		6AV2107-0DB00-0AL0
WinCC RT Professional 128	6AV2105-3BB06-0AE0	6AV2105-0XA00-0AL0
WinCC RT Professional 512	6AV2105-3DD06-0AE0	
WinCC RT Professional 2k	6AV2105-3FF06-0AE0	
WinCC RT Professional 4k	6AV2105-3HH06-0AE0	
WinCC RT Professional 8k	6AV2105-3KK06-0AE0	
WinCC RT Professional 64k-250k	6AV2105-3MM06-0AE0	

The information in SIOS is available: <https://support.industry.siemens.com/cs/ww/en/view/109751896>

SIMATIC WinCC Professional Powertags

Server

The number of WinCC Runtime Professional PowerTags for the server is selectable.

Power Packs extend the number of available tags.

The total price remains constant.

Client

The Client is being deployed for

- WinCC RT Professional Client

Or

- WinCC RT Professional 128

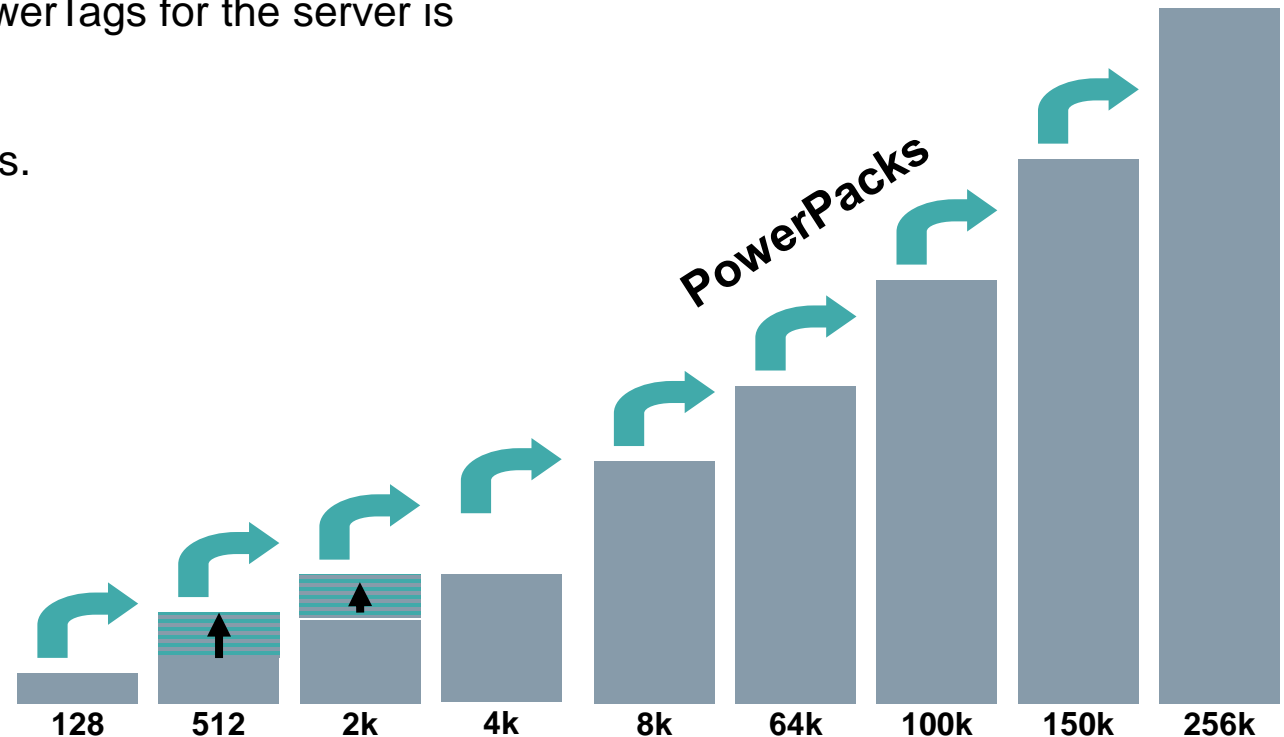

SIMATIC WinCC Professional Engineering Upgrade WinCC in TIA Portal (V13.SPx to V16)



... WinCC Professional V11 to V16	<u>Online Software Delivery</u>	SUS
<ul style="list-style-type: none"> • WinCC Professional V16 512 • WinCC Professional V16 4096 • WinCC Professional V16 max. • WinCC Prof.V16 512 Powertags SUS DL • WinCC Prof.V16 4096 Powertags SUS DL • WinCC Prof.V16 max. Powertags SUS DL 	6AV2103-3DA06-0AE5 6AV2103-3HA06-0AE5 6AV2103-3XA06-0AE5	6AV2103-3DA06-0AK5 6AV2103-3HA06-0AK5 6AV2103-3XA06-0AK5
		6AV21030DA000AY0 6AV21030HA000AY0 6AV21030XA000AY0

SIMATIC WinCC Professional Migration from WinCC V7 RC/RT

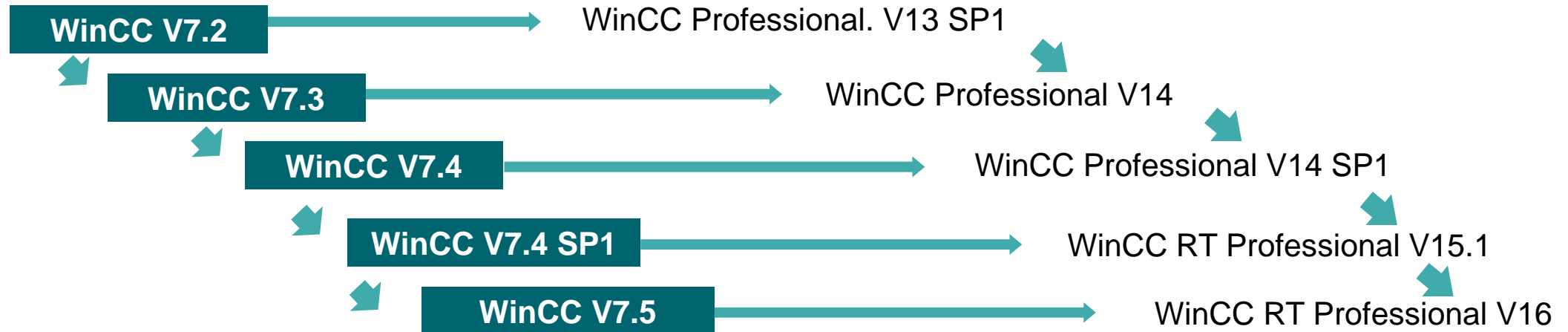

WinCC RC/RT V7.0...V7.5 → WinCC V16			OSD
V7 RT Client	→ WinCC RT Professional Client	6AV2107-4DB06-0AE0	6AV2107-4DB06-0AK0
V7 RC/RT 128	→ RT Prof. 128	6AV2105-4BB06-0AE0	6AV2105-4BB06-0AK0
V7 RC/RT 512	→ RT Prof. 512	6AV2105-4DD06-0AE0	6AV2105-4DD06-0AK0
V7 RC/RT 2k	→ RT Prof. 2k	6AV2105-4FF06-0AE0	6AV2105-4FF06-0AK0
V7 RC/RT 8k	→ RT Prof. 8k	6AV2105-4KK06-0AE0	6AV2105-4KK06-0AK0
V7 RC/RT 64k	→ RT Prof. >= 64k	6AV2105-4MM06-0AE0	6AV2105-4MM06-0AK0

When upgrading from V7 RC/RT, ONLY the RT Professional license will be delivered with immediate effect. The WinCC Professional Engineering software must be ordered separately if required.

Engineering: WinCC RT Professional V16

The following security programs were tested:

SIEMENS
Ingenuity for life

- Trend Micro "Office Scan" 12.0
- Symantec Endpoint Protection V14.0
- McAfee Endpoint Security (ENS) 10.5
- Kaspersky Endpoint Security 11.1
- Windows Defender (version contained in the operating system)
- Qihoo 360 "Safe Guard 11.5" + "Virus Scanner"



Symantec™



Runtime

- WinCC differentiates between RT licenses (Runtime) and ES licenses (Configuration) as well as the number of tags.
- RT licenses permit the operation of WinCC in runtime for an unlimited period of time. With this license you can use up to 262 144 external tags and up to 500 archive tags (WinCC Logging) in Runtime. Engineering is not possible.
- New :... the license for sporadic use:50h of actual use – where the usage can be interrupted as often as required

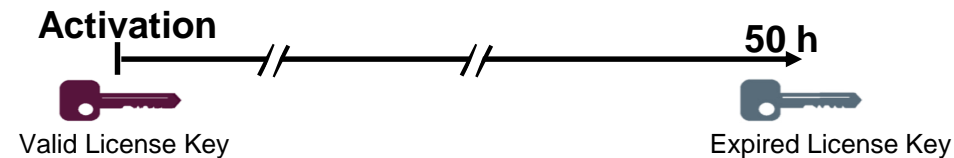

Engineering

A license key is required for:

- WinCC Engineering System, e.g. WinCC Professional
- Options for WinCC Engineering System

Web options

- The license type of the web options (WEBNAVIGATOR, DATAMONITOR and WebUX) becomes consistently countable.

SIMATIC WinCC Professional V16

Order data Logging

... Runtime Professional V16 Logging*)		<u>Online Software Delivery</u>
<ul style="list-style-type: none"> • 1500 Logging Tags • 5000 Logging Tags 	<p>6AV2107-0GB00-0BB0</p> <p>6AV2107-0GD00-0BB0</p>	<p>6AV2107-0GB00-0BH0</p> <p>6AV2107-0GD00-0BH0</p>
<ul style="list-style-type: none"> • 1500 -> 5000 Logging Tag 	Not applicable due to conversion to additive licenses!	

- **WinCC Professional** contains 500 Archive Tags in the base system
- **WinCC Logging Tags** are expandable by: 1500 and 5000.
- Archive licenses can be combined/ pooled (countable licenses).
- WinCC Professional supports **up to 80k Archive Tags**

+5000 Archive Tags
+1500 Archive Tags
500 Archive Tags

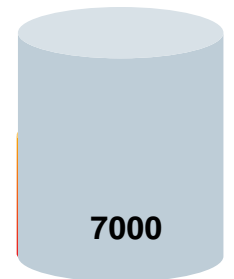

***) Number of tags are additive, i.e. total archive tags = sum of individual licenses**

WinCC RT Professional V16 basic station

Article numbers



SIMATIC WinCC Professional xx PowerTags V16 Engineering

Description	Order number EU		Order number ASIA
	DVD	Online Software Download	DVD
512 PowerTags	6AV2103-0DA06-0AA5	6AV2103-0DA06-0AH5	-
4096 PowerTags	6AV2103-0HA06-0AA5	6AV2103-0HA06-0AH5	-
Max PowerTags	6AV2103-0XA06-0AA5	6AV2103-0XA06-0AH5	-
NEW: SIMATIC 50h Engineering with STEP 7 Professional V14 SP1 Combo , SIMATIC 50h Engineering with STEP 7 Professional Combo, WinCC Professional (incl. WinCC flexible 2008) and STEP 7 Safety Advanced (incl. Distributed Safety)		6ES7823-1GE06-0YA5	-

SIMATIC WinCC Runtime Professional ... PowerTags V16 Basis Package (RT incl. 500 Archive Variables) (RT incl. 500 Archive Variables and one WebUX Monitor Client)

128 PowerTags	6AV2105-0BA06-0AA0	6AV2105-0BA06-0AH0	6AV2105-0BA16-0AA0
512 PowerTags	6AV2105-0DA06-0AA0	6AV2105-0DA06-0AH0	6AV2105-0DA16-0AA0
2048 PowerTags	6AV2105-0FA06-0AA0	6AV2105-0FA06-0AH0	6AV2105-0FA16-0AA0
4096 PowerTags	6AV2105-0HA06-0AA0	6AV2105-0HA06-0AH0	6AV2105-0HA16-0AA0
8192 PowerTags	6AV2105-0KA06-0AA0	6AV2105-0KA06-0AH0	6AV2105-0KA16-0AA0
65536 PowerTags	AV2105-0MA06-0AA0	6AV2105-0MA06-0AH0	6AV2105-0MA16-0AA0
102400 PowerTags	6AV2105-0PA06-0AA0	6AV2105-0PA06-0AH0	6AV2105-0PA16-0AA0
153600 PowerTags	6AV2105-0RA06-0AA0	6AV2105-0RA06-0AH0	6AV2105-0RA16-0AA0
262144 PowerTags	6AV2105-0TA06-0AA0	6AV2105-0TA06-0AH0	6AV2105-0TA16-0AA0
WinCC Client for RT Prof V15	6AV2107-0DB06-0AA0	6AV2107-0DB06-0AH0	6AV2107-0DB16-0AA0

Please note the price advantage for Online Software Delivery!

SIMATIC WinCC Professional Order Data Engineering / Trial



Link to compatibility list: [Compatibility List](#)

... Trial Software		<u>Online Software Delivery</u>
<ul style="list-style-type: none">Engineering Trial Software V16 WinCC Basic / Comfort / Advanced	6AV2102-0AA06-0AA7	
<ul style="list-style-type: none">SIMATIC WinCC Professional V16, Trial License	6AV2103-0AA06-0AA7	Download in Customer Support Portal

Integrated licensing concept

NEW as of WinCC V7.4 / RT Professional V14

Web solutions with WebNavigator and WebUX

In the future, these SCADA options will have **standardized MLFBs as of V7.4 or V14** and therefore there will no longer be any in-house MLFBs for **WinCC RT Professional V15**

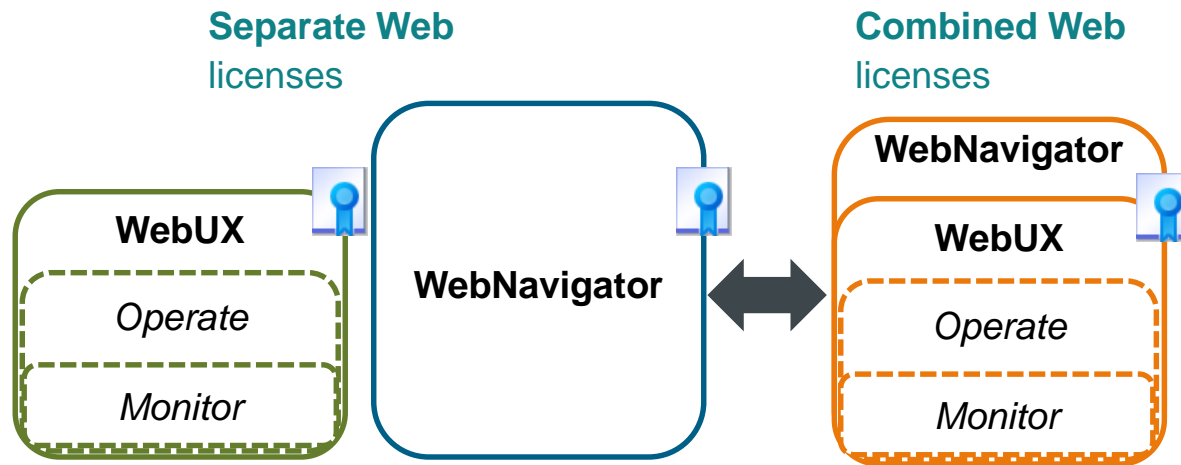

IIS on Windows 10 supports a maximum of **ten connections** or instances. WebUX requires more than one connection for a client. Therefore, a maximum of **three WebUX** clients can connect to the WebUX server. If the limit is exceeded, you can no longer operate the instances already connected

Scalable web access

Switching between two license models:

- Separate or combined Web-licenses
WebUX Monitor Client (read only)
WebUX Operate Client (read-write)
Web Navigator Client (read-write)

Web Licenses are additive:

- all WebClients = sum of the individual licenses (**countable**)
• (1, 3, 10, 30, 100 clients)
- Reserving licenses for users
- No update costs, because version-independent licenses (existing licenses remain valid after upgrade)

1x WinCC WebUX Monitor Client FREE!

Integrated licenses

NEW as of WinCC V7.4 SP1 / WinCC RT Professional V14



WinCC WebNavigator (countable)

Description	Order number: DVD EU	Order number Online Software Download EU	Order number: DVD ASIA
WinCC WebNavigator - 1 Client	6AV6362-1AB00-0BB0	6AV6362-1AB00-0AH0	6AV6362-1AB00-0BB0
WinCC WebNavigator - 3 Clients	6AV6362-1AD00-0BB0	6AV6362-1AD00-0AH0	6AV6362-1AD00-0BB0
WinCC WebNavigator - 10 Clients	6AV6362-1AF00-0BB0	6AV6362-1AF00-0AH0	6AV6362-1AF00-0BB0
WinCC WebNavigator - 30 Clients	6AV6362-1AJ00-0BB0	6AV6362-1AJ00-0AH0	6AV6362-1AJ00-0BB0
WinCC WebNavigator - 100 Clients	6AV6362-1AM00-0BB0	6AV6362-1AM00-0AH0	6AV6362-1AM00-0BB0
WinCC WebNavigator Diagnostic Client	6AV6362-1BA00-0BB0	6AV6362-1BA00-0AH0	6AV6362-1BA00-0BB0

WinCC DataMonitor (countable)

Description	Order number: DVD EU	Order number : Online Software Download EU	Order number: DVD ASIA
WinCC DataMonitor - 1 Client	6AV6362-3AB00-0BB0	6AV6362-3AB00-0AH0	6AV6362-3AB00-0BB0
WinCC DataMonitor - 3 Clients	6AV6362-3AD00-0BB0	6AV6362-3AD00-0AH0	6AV6362-3AD00-0BB0
WinCC DataMonitor - 10 Clients	6AV6362-3AF00-0BB0	6AV6362-3AF00-0AH0	6AV6362-3AF00-0BB0
WinCC DataMonitor - 30 Clients	6AV6362-3AJ00-0BB0	6AV6362-3AJ00-0AH0	6AV6362-3AJ00-0BB0

Integrated licenses

NEW from WinCC V7.4 / WinCC RT Professional V14



WinCC WebUX (Monitor countable)

Description	Order number: DVD EU	Order number Online Software Download EU	Order number: DVD ASIA
WinCC WebUX Monitor 1 Client	6AV6362-2AB00-0BB0	6AV6362-2AB00-0AH0	6AV6362-2AB00-0BB0
WinCC WebUX Monitor 3 Clients	6AV6362-2AD00-0BB0	6AV6362-2AD00-0AH0	6AV6362-2AD00-0BB0
WinCC WebUX Monitor 10 Clients	6AV6362-2AF00-0BB0	6AV6362-2AF00-0AH0	6AV6362-2AF00-0BB0
WinCC WebUX Monitor 30 Clients	6AV6362-2AJ00-0BB0	6AV6362-2AJ00-0AH0	6AV6362-2AJ00-0BB0
WinCC WebUX Monitor 100 Clients	6AV6362-2AM00-0BB0	6AV6362-2AM00-0AH0	6AV6362-2AM00-0BB0

WinCC WebUX (Operate countable)

Description	Order number: DVD EU	Order number Online Software Download EU	Order number: DVD ASIA
WinCC WebUX Operate 1 Client	6AV6362-2BB00-0BB0	6AV6362-2BB00-0AH0	6AV6362-2BB00-0BB0
WinCC WebUX Operate 3 Clients	6AV6362-2BD00-0BB0	6AV6362-2BD00-0AH0	6AV6362-2BD00-0BB0
WinCC WebUX Operate 10 Clients	6AV6362-2BF00-0BB0	6AV6362-2BF00-0AH0	6AV6362-2BF00-0BB0
WinCC WebUX Operate 30 Clients	6AV6362-2BJ00-0BB0	6AV6362-2BJ00-0AH0	6AV6362-2BJ00-0BB0
WinCC WebUX Operate 100 Clients	6AV6362-2BM00-0BB0	6AV6362-2BM00-0AH0	6AV6362-2BM00-0BB0

WinCC RT Professional V16 ?

In which case WinCC RT Advanced / WinCC V7 ?

WinCC RT Advanced

- Single user system with max 16 384 PowerTags
- No clients
- Support of bit messages and analog messages as well as the event-controlled alarm procedure Alarm-S / D for SIMATIC S7
- Recipes:
Creation of data sets for machine data or production data
- WinCC Logging
For archiving variables and messages

WinCC V7

- 18 servers
- 64 clients or
- 50 multi-clients
- 150 web clients
- 2 Server (redundant)
- Possibility to connect to SAP Hana/SAP R3 via PM Add ons
- KPI evaluation (see V7 Performance Monitor)
- Connection of telecontrol stations (WinCC V7 TeleControl)
- Generierung from Tags, Messages, pictures, Trend with VBA
-

WinCC RT Professional V16

In which case WinCC RT Professional V16?

Project TIA Portal for SPS / SCADA

- Perfect integration into the TIA Portal => customer has been using and is familiar with the TIA Portal for a long time
- WinCC integrated
- System diagnosis, time stamping at source
- Process diagnosis
- SIMATIC Energy Suite
- Generierung from pictures with SiVArc
- Intelligentes Lastmanagement

System Architecture

good SCADA solution for small to medium solutions

1 server (optional redundant) maximum 32 clients

WinCC RT Professional V16

Communication with the process

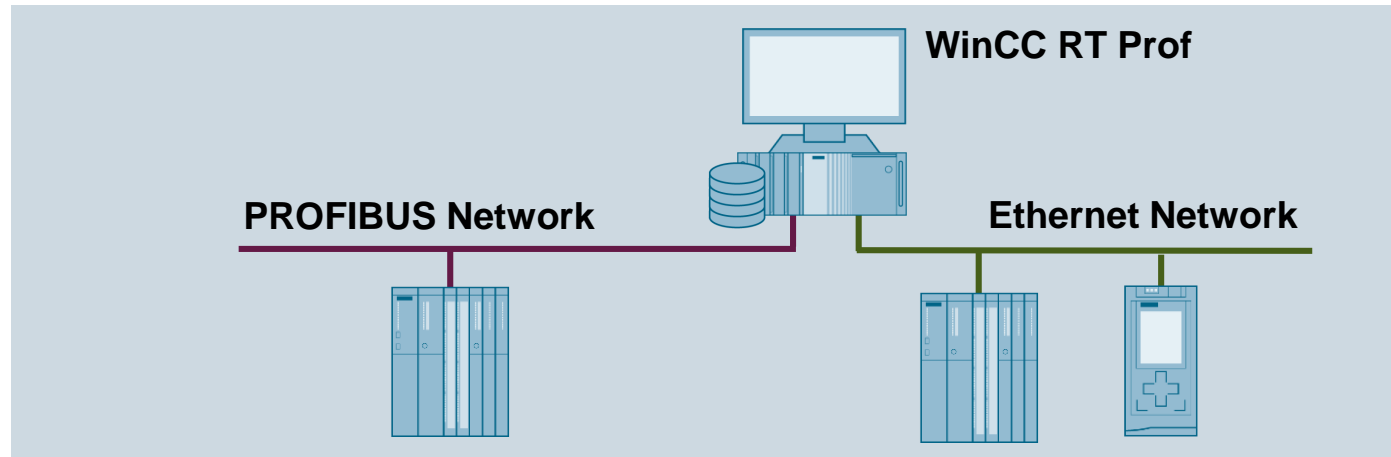

Ethernet Card of the PC:

- SOFTNET-IE S7
max. **64** connections (6GK1704-1CW16-0AA0)
- SOFTNET-IE S7 Extended
max. **128 connections** (6GK1704-1BW16-0AA0)

With CP

- CP 1623 PCIe: (6GK1162-3AA00)

CP 5621 PCIe Softnet Module

- S7 MPI/PROFIBUS protocols included in WinCCCP 5613 A2 PCI
- ### Hardnet Module
- S7 MPI/PROFIBUS protocols
 - A license is required

WinCC RT Professional V16 supports max 128 S7 connections of which:

- max. **128 x S7-1200 / S7-1500** Connections
- max. **64 x S7-300/400** Connections

Ethernet Card of the PC

- Protocols 1200/1500, S7 TCP/IP, Ind. Eth
- Licenses for
- SOFTNET-IE S7 Lean max. 8 connections (included in the WinCC package)
- With > 8 connections => license required for Softnet-IE S7

CP 1623 PCIe Hardnet Assembly (license for Hardnet-IE S7 (S7 1613) required)

- *It is recommended that you use separate network cards for reducing the load on the PC-CPU*
 - max. **128 x S7-1500/1200** Connections
 - max. **64 x S7-1500/1200** Connections
 - max. **64 x S7-300/400** Connections
- Example:
- LAN Card 1: 64 x 1200/1500
+ LAN Card 2: 64 x 300/400

Single-user system

Operator control and monitoring with a single PC

Single-user system Engineering Station+ WinCC RT Prof

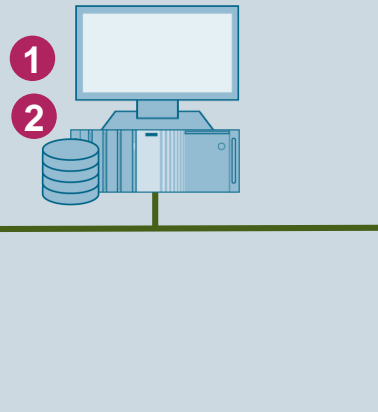

Additional information

- Quantity Structure:
 - Process tags: up to 262 144 (depending on license selected)
 - Archive tags: max. 80 000 (depending on WinCC Logging option)
- (Note: WinCC Pro 500 archive tags are included in the basic version.)

1 Basis Paket = SIMATIC WinCC Runtime Professional PowerTags V16

WinCC RT Prof n

e. g.:

- 512 PowerTags
- 2048 PowerTags
- 4096 PowerTags
- 8192 PowerTags
- 65 536 PowerTags
- 102 400 PowerTags
- 153 600 PowerTags
- 262 144 PowerTags

SIMATIC Net V16

2 SIMATIC WinCC Engineering System Base Package V16

- 512 PowerTags
- 4096 PowerTags
- Max. PowerTags

Redundant single-user systems - 2 operator control and monitoring stations with a high degree of availability

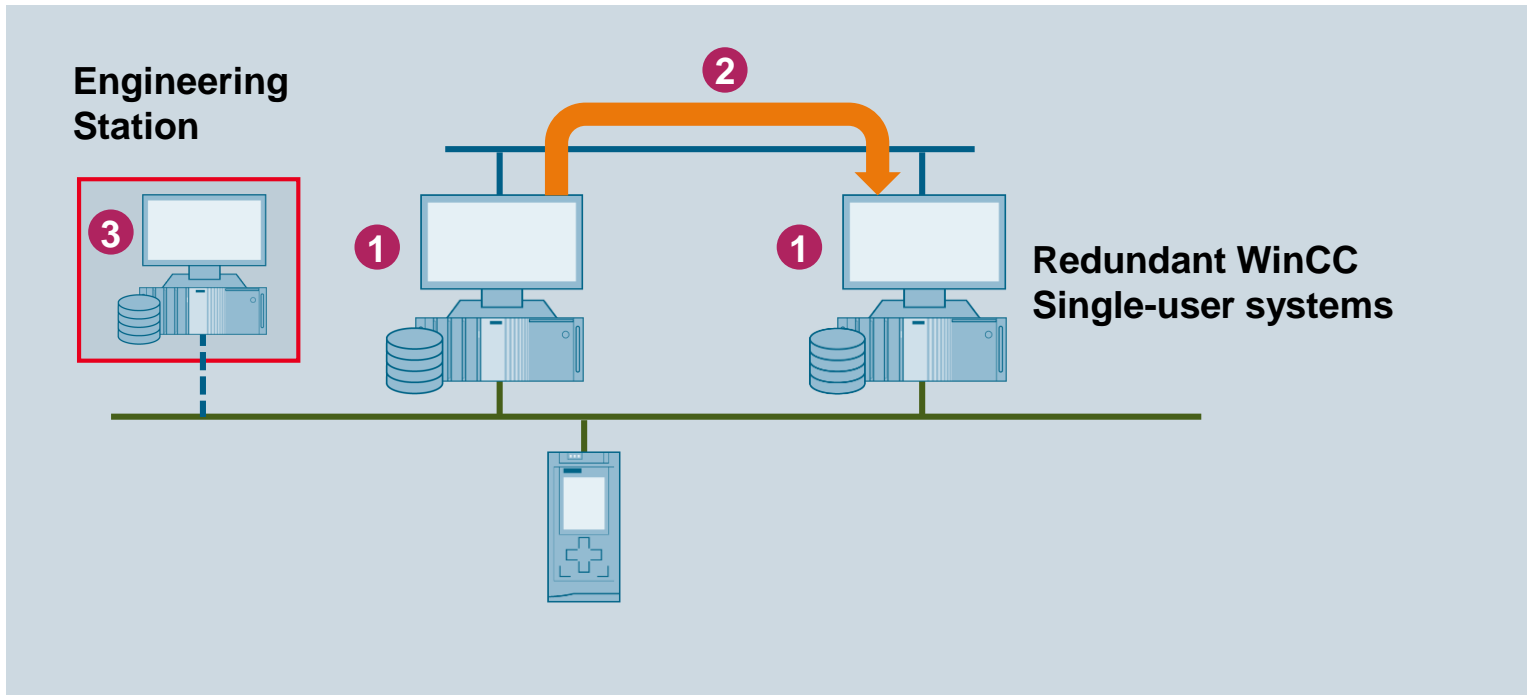

1 Base Package

WinCC RT Prof n
SIMATIC Net V16

2 WinCC Redundancy

MLFB: 6AV2107-0FB00-0BB0

3 WinCC Engineering

- 512 PowerTags
- 4096 PowerTags
- max PowerTags

Additional information

- The two stations run in parallel (both are connected to the process). In the event of a fault
- in one of the two WinCC stations, the other takes over the archiving of messages, and the process/user data (recipe). Automatic synchronization of all archives
- after restoration of the normal operating state.

Redundant Single-User Systems Engineering station

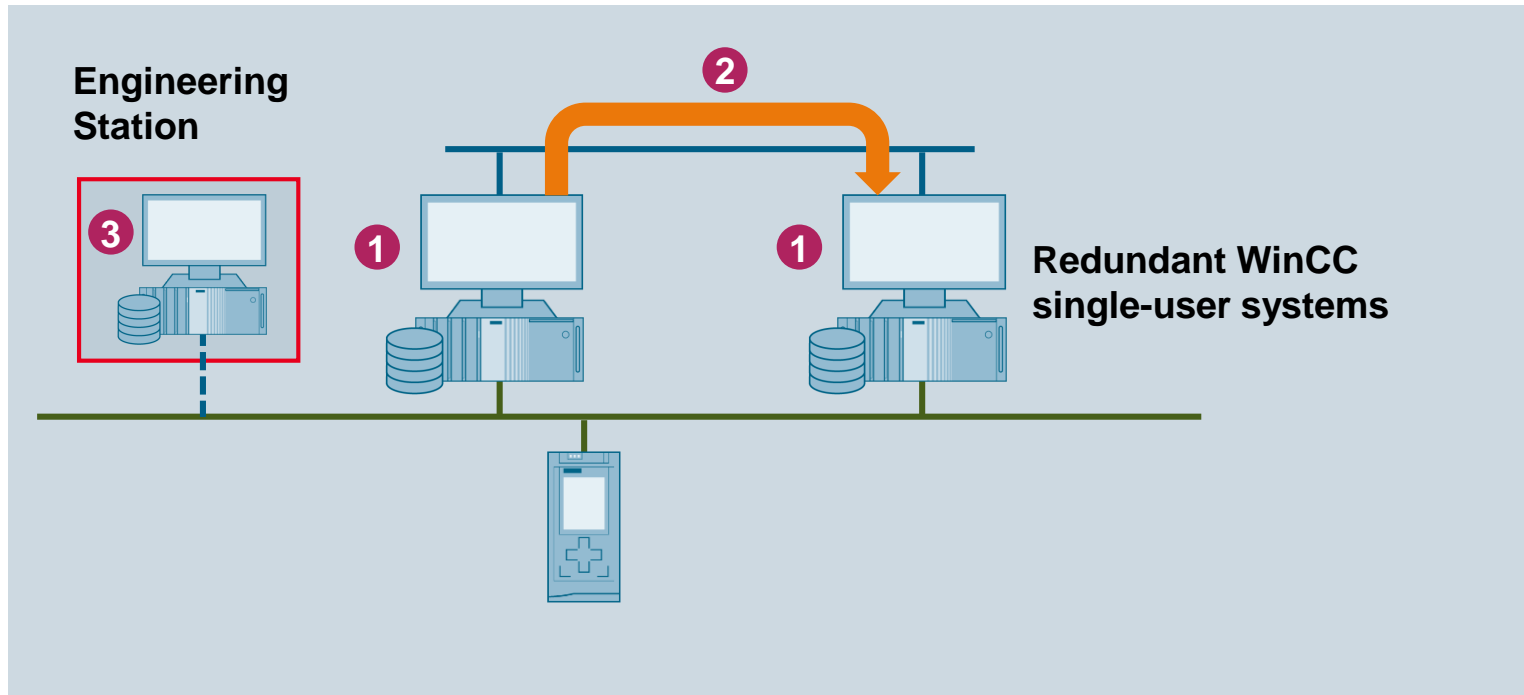

1 Base Package

WinCC RT Prof n
SIMATIC Net V16

2 WinCC Redundancy

MLFB: 6AV2107-0FB00-0BB0

3 WinCC Engineering

- 512 PowerTags
- 4096 PowerTags
- max PowerTags

IMPORTANT

Changes can be made in the two WinCC servers via the engineering station.

The requirement for this is that the engineering station must be configured, for example, with:

- WinCC Prof V16 or
- WinCC Prof V16 + STEP 7 Basic V16 (S7-1200) or STEP 7 Prof V16 (S7-1500)

WinCC Recipes

Recipe management

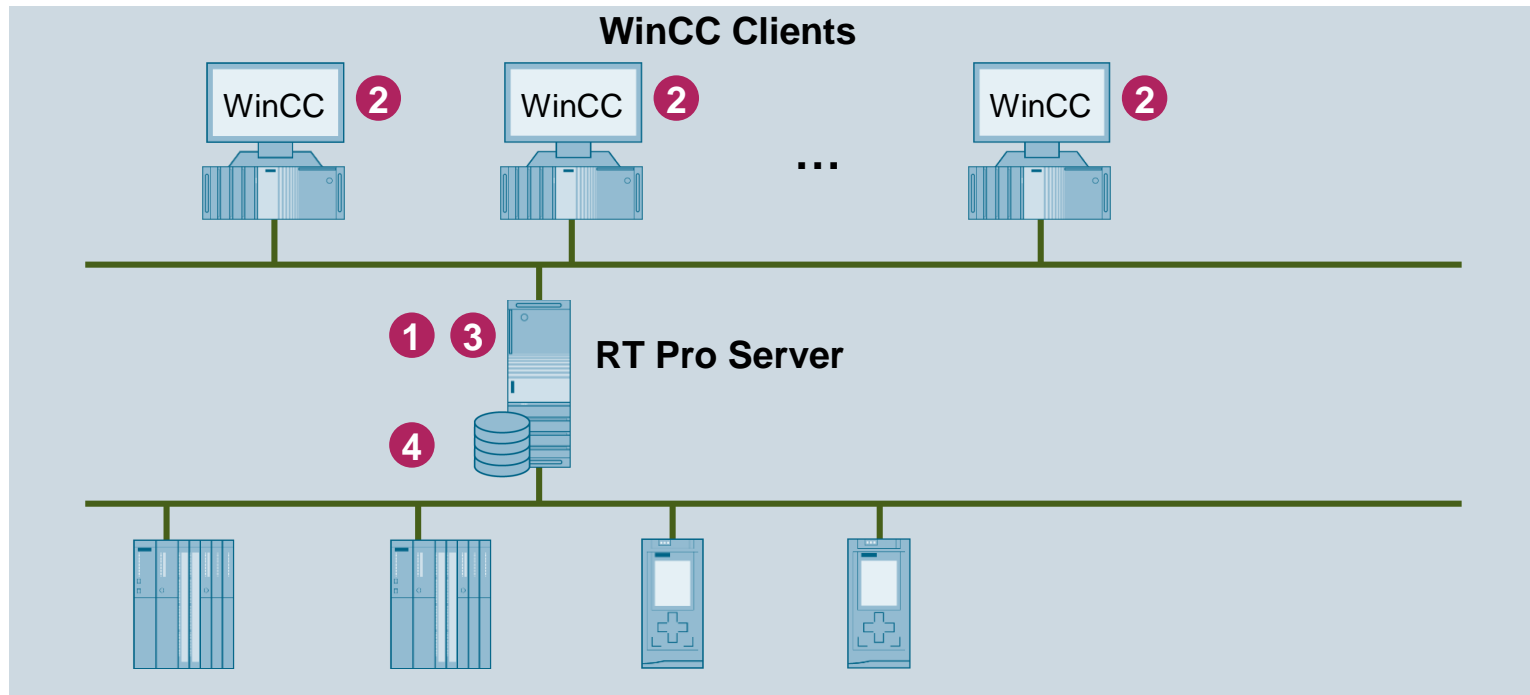

1 Base Package

WinCC RT Prof
SIMATIC Net V16

2 WinCC Client

MLFB: [6AV2107-0DB06-0AA0](#)

3 WinCC Server

MLFB: [6AV2107-0EB00-0BB0](#)

4 WinCC Recipes

MLFB: [6AV2107-0JB00-0BH0](#)

With WinCC Recipes, the user can manage his archives in tabular form,
E. g.: Recipe management – managing the batch parameters, ...
The recipe license is located on the server.

WinCC Logging Archive tags

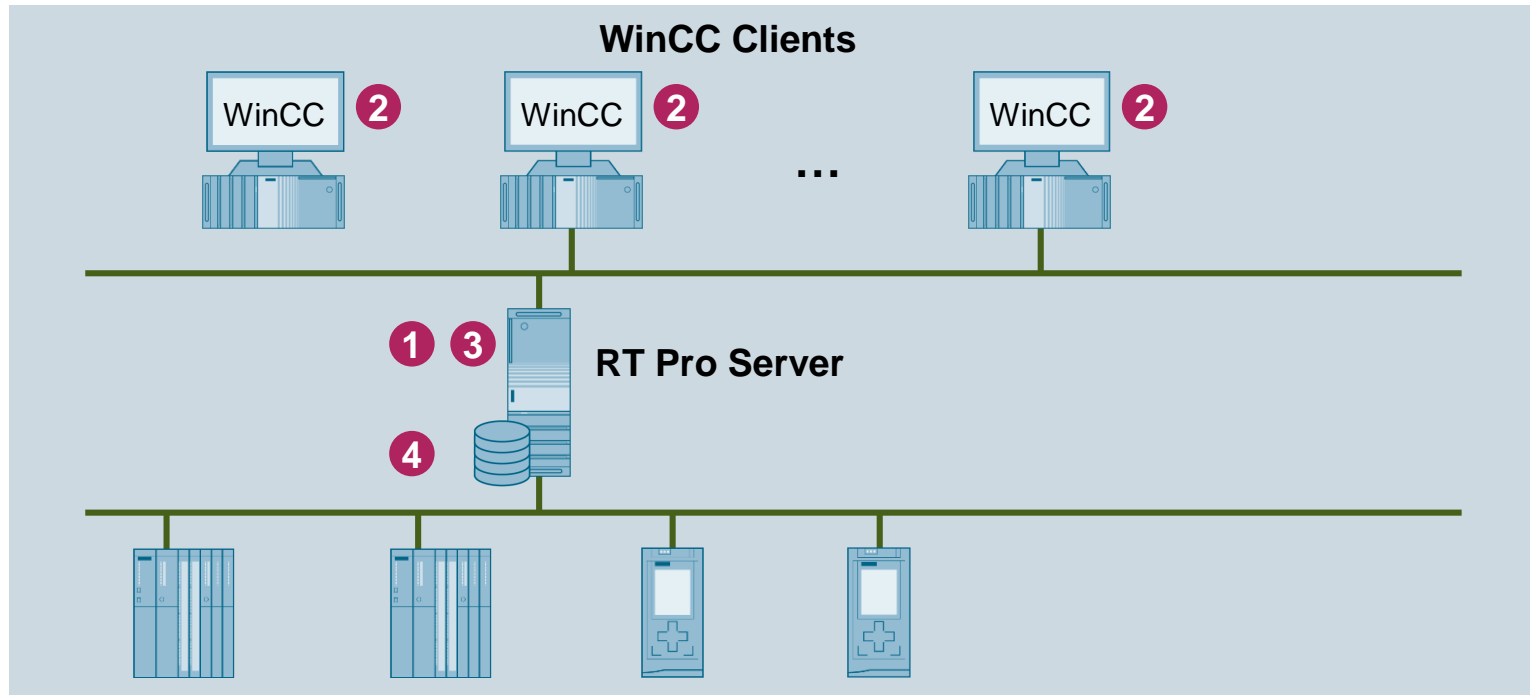

The number of the archive tags can be increased with WinCC Logging. (countable licenses)

- The license for 500 archive tags is included in the basic package.
- The logging license is located on the server.
- With a license for 1500 archive tags and the basic license for 500 archive tags, you then have 2000 archive tags at your disposal

1 Base Package

**WinCC RT Prof
SIMATIC Net V16**

2 WinCC Client

MLFB: **6AV2107-0DB06-0AA0**

3 WinCC Server

MLFB: **6AV2107-0EB00-0BB0**

4 WinCC Logging

e. g.: 1500 archive tags

MLFB: **6AV2107-0GB00-0BB0**

e. g.: 5000 archive tags

MLFB: **6AV2107-0GD00-0BB0**

Multi-user systems – central server with operating and monitoring stations: Only standard client

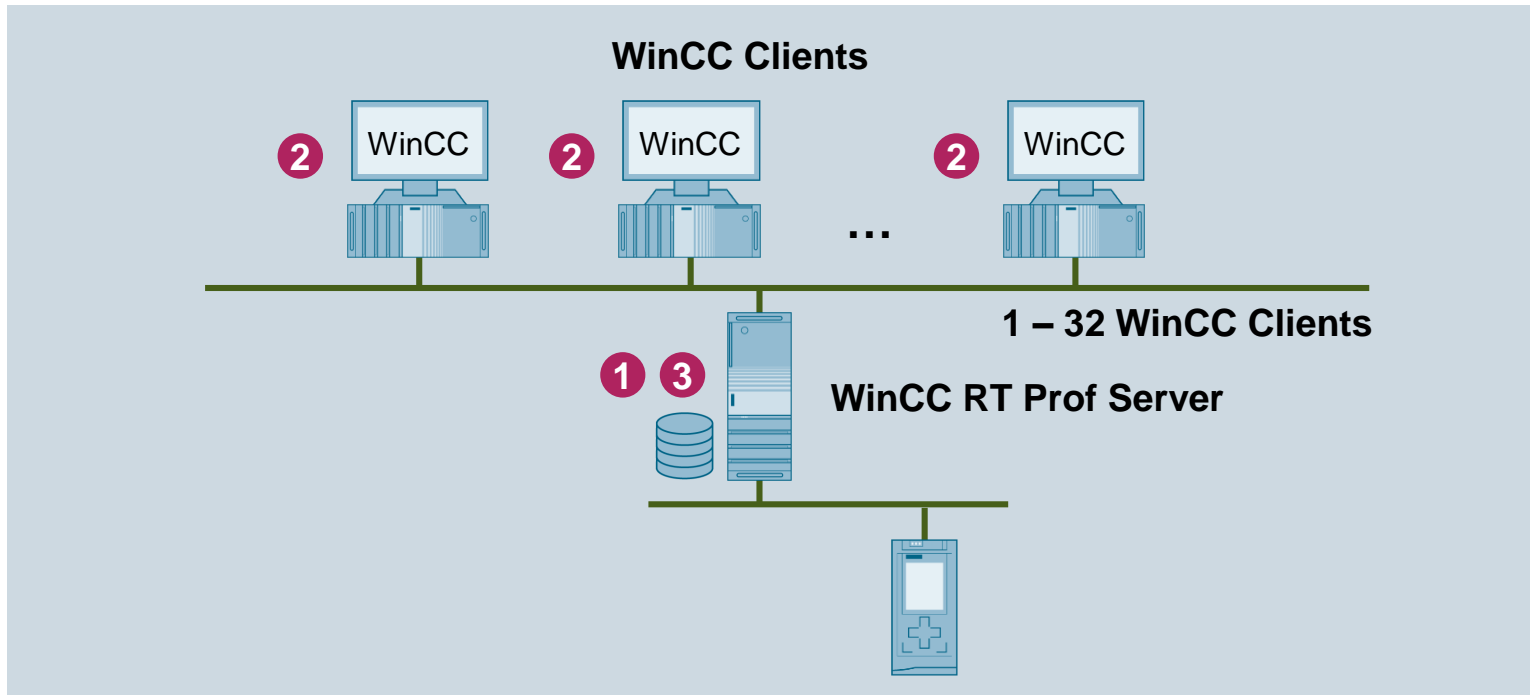

1 Base Package

WinCC RT Prof n
SIMATIC Net V16

2 WinCC Client

MLFB: 6AV2107-0DB06-0AA0

3 WinCC Server

MLFB: 6AV2107-0EB00-0BB0

Please note

A standard client does not have a WinCC project. It is connected to a specific server from which it receives data and views.

Multi-user systems with standard clients – Engineering Scenario 1 – Development on the server

Case 1: The engineering license is located on the server. Changes to the project are made directly on the server.

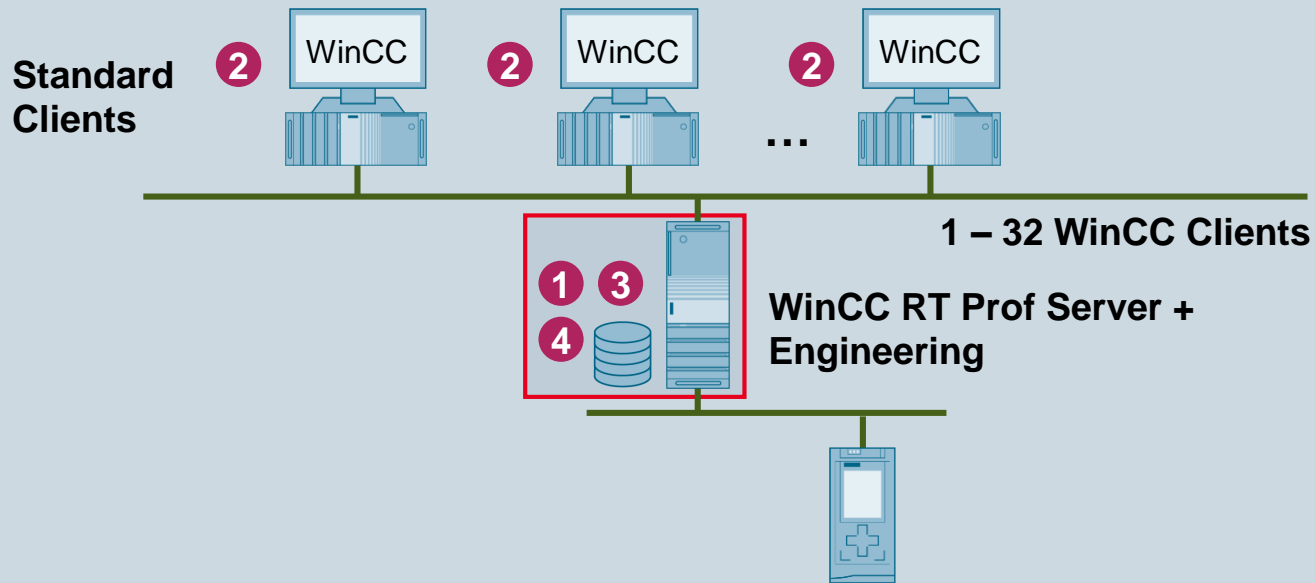

To be observed – Differences compared to the preceding scenario:
An engineering license is also required on the server.
TIA is possible (i.e. STEP 7 can be installed on the server.)

In the event of changes, it may be necessary to shut down the server.

1 Base Package

WinCC RT Prof n
SIMATIC Net V16

2 WinCC Client

MLFB: 6AV2107-0DB06-0AA0

3 WinCC Server

MLFB: 6AV2107-0EB00-0BB0

4 WinCC Engineering

- 512 PowerTags
- 4096 PowerTags
- max PowerTags

Multi-user systems with standard clients – Engineering Scenario 2 – Engineering station

Case 2: Changes are made on an in-house engineering station
(e.g.: work station of a system integrator who is not constantly connected)

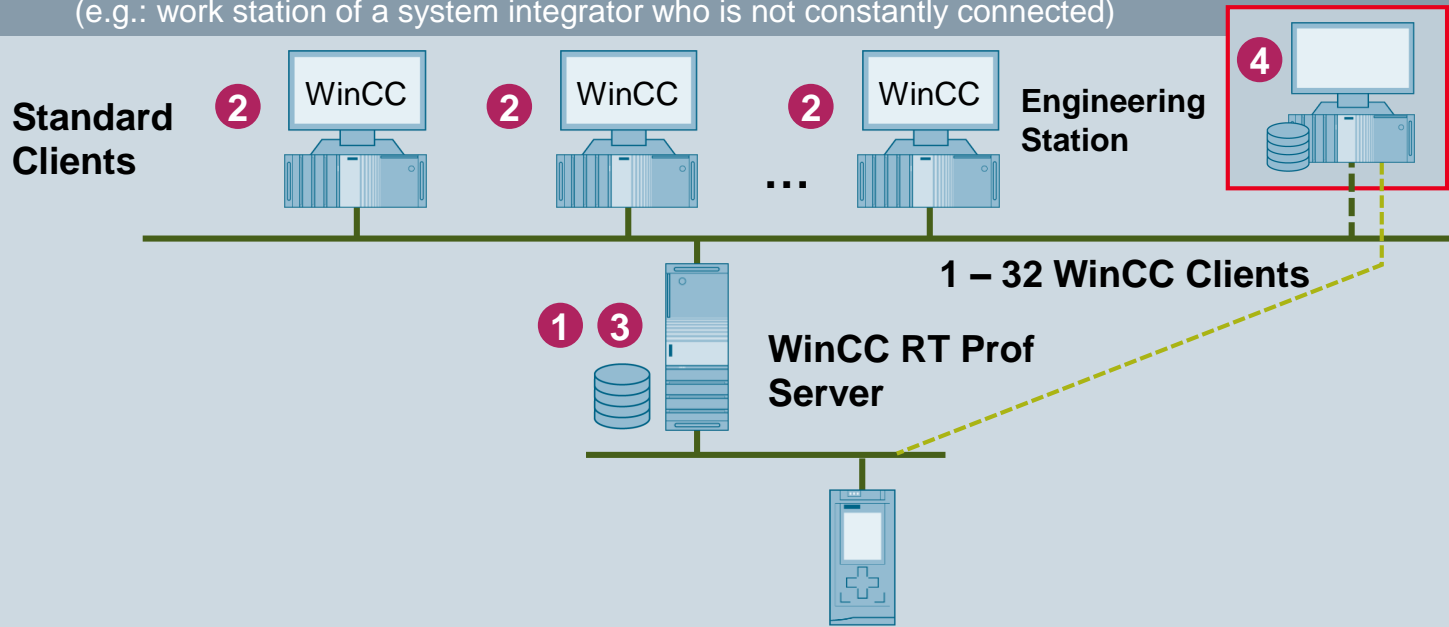

1 Base Package

WinCC RT Prof n
SIMATIC Net V16

2 WinCC Client

MLFB: **6AV2107-0DB06-0AA0**

3 WinCC Server

MLFB: **6AV2107-0EB00-0BB0**

4 WinCC Engineering

- **512 PowerTags**
- **4096 PowerTags**
- **max PowerTags**

IMPORTANT

Changes can be made on the WinCC server via the engineering station.
The requirement for this is that the engineering station must be configured.

Multi-user systems with standard clients – Engineering Scenario 3 – Engineering station on a client

Case 3: Changes are made on an engineering station that is running on a client
(e.g.: work station of a maintenance employee)

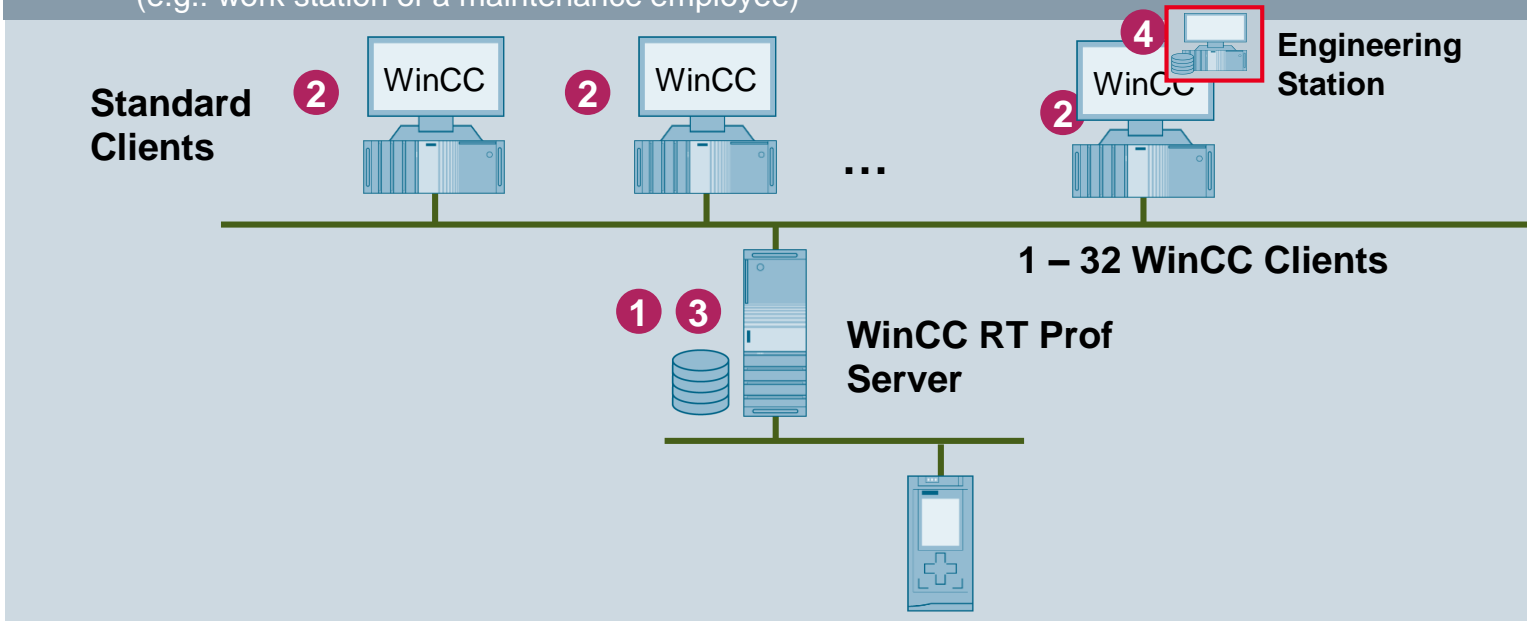

1 Base Package

WinCC RT Prof n
SIMATIC Net V16

2 WinCC Client

MLFB: 6AV2107-0DB06-0AA0

3 WinCC Server

MLFB: 6AV2107-0EB00-0BB0

4 WinCC Engineering

WinCC Prof (512 / 4096 / max)

IMPORTANT

Changes can be made on the WinCC server via the engineering station.
The requirement for this is that the engineering station must be configured.

Analysis + Reporting with PM-ANALYZE Installation Variants

*Installation on a separate server requires a Microsoft SQL Server 2008, 2014,2016 (32/64).

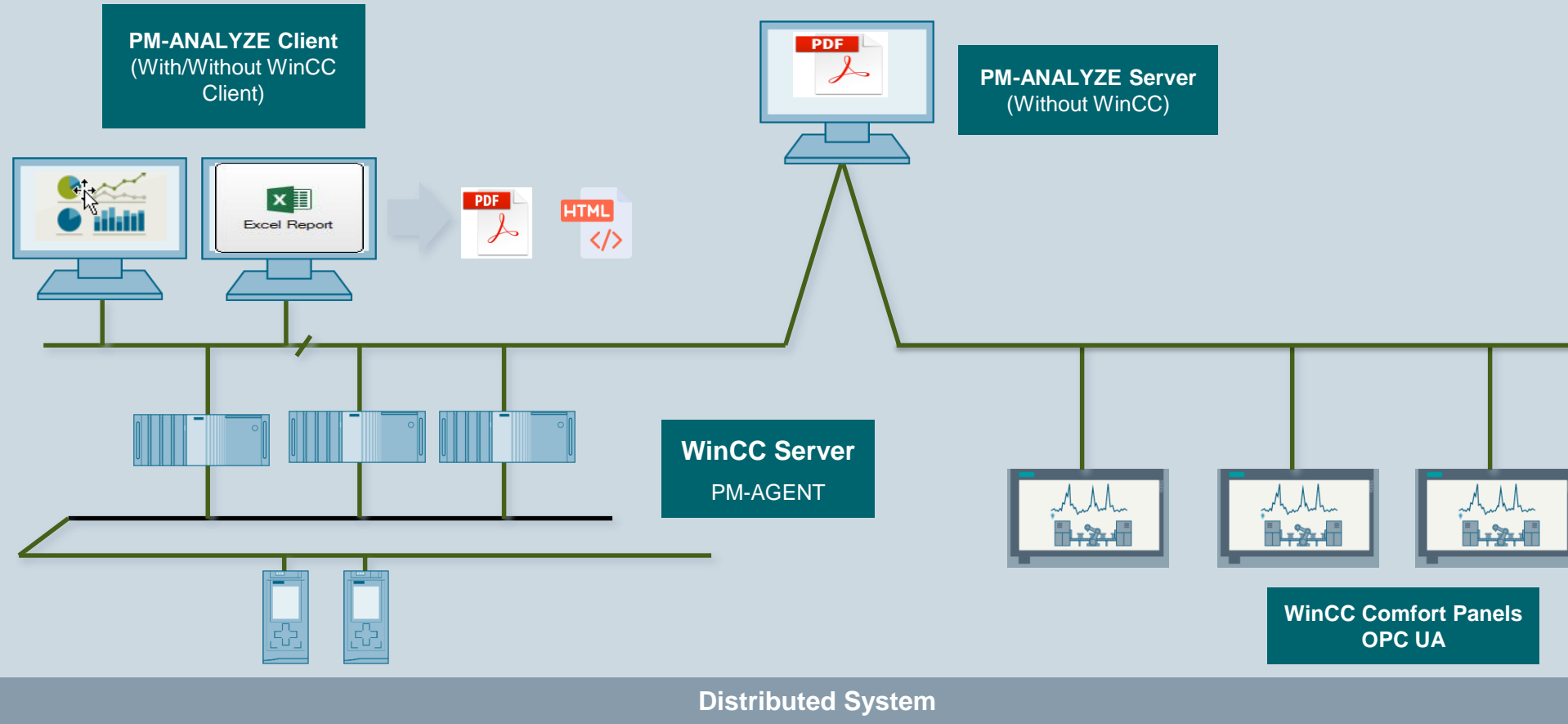

SIMATIC Information Server – Reporting System in the web

PC with reporting with dashboards on HTML5-capable browser or via Office (Microsoft Excel, Word, PowerPoint)

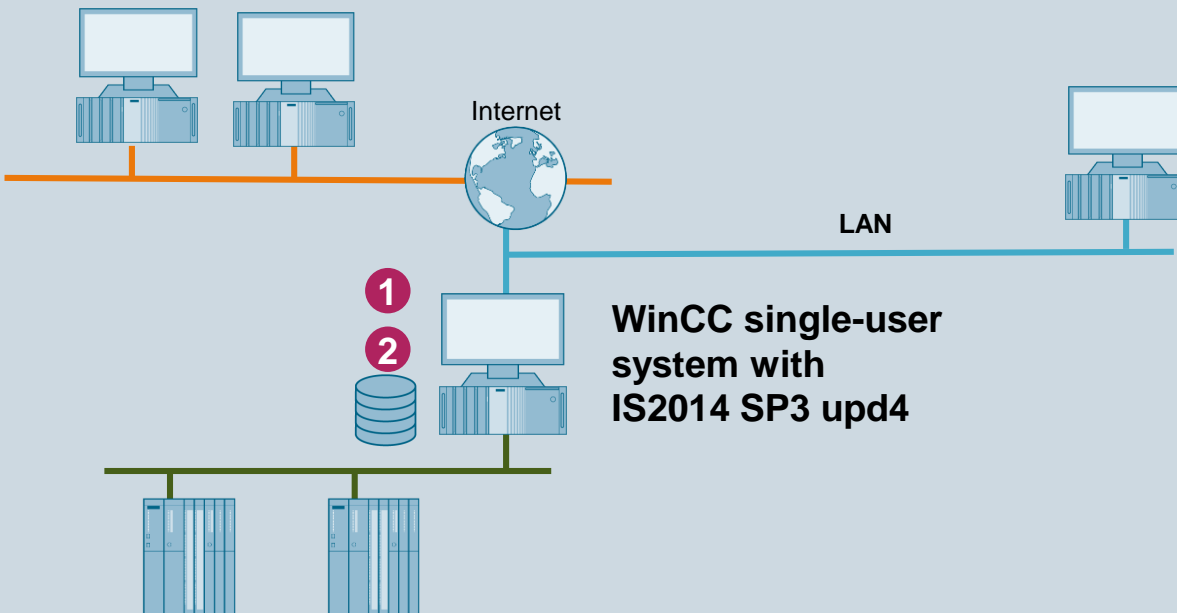

Additional Information

Standard and user-specific reports (via Report Builder of MS SQL Reporting Services)
Transparent access to WinCC-Archive in Excel and Word (2007, 2010, 2013 and 2016).

1 Base Package

WinCC RT Prof n
SIMATIC Net V16

2 WinCC IS 2014 SP3 upd4 Base Package

MLFB: **6AV6361-2AA01-4AA0**

The base package contains:

- 1 x data source access
(connection with a WinCC database)
- 3 x client access
(three simultaneous client accesses)

Note:

Information Server 2014 SP3 upd4
is compatible with

- WinCC RT Prof V13 SP1 or higher
- WinCC 7.0 SP3 or higher
- WinCC OA 3.14 or higher
- SIMATIC Process Historian 2014 SP2

SIMATIC Information Server – Reporting system in the web

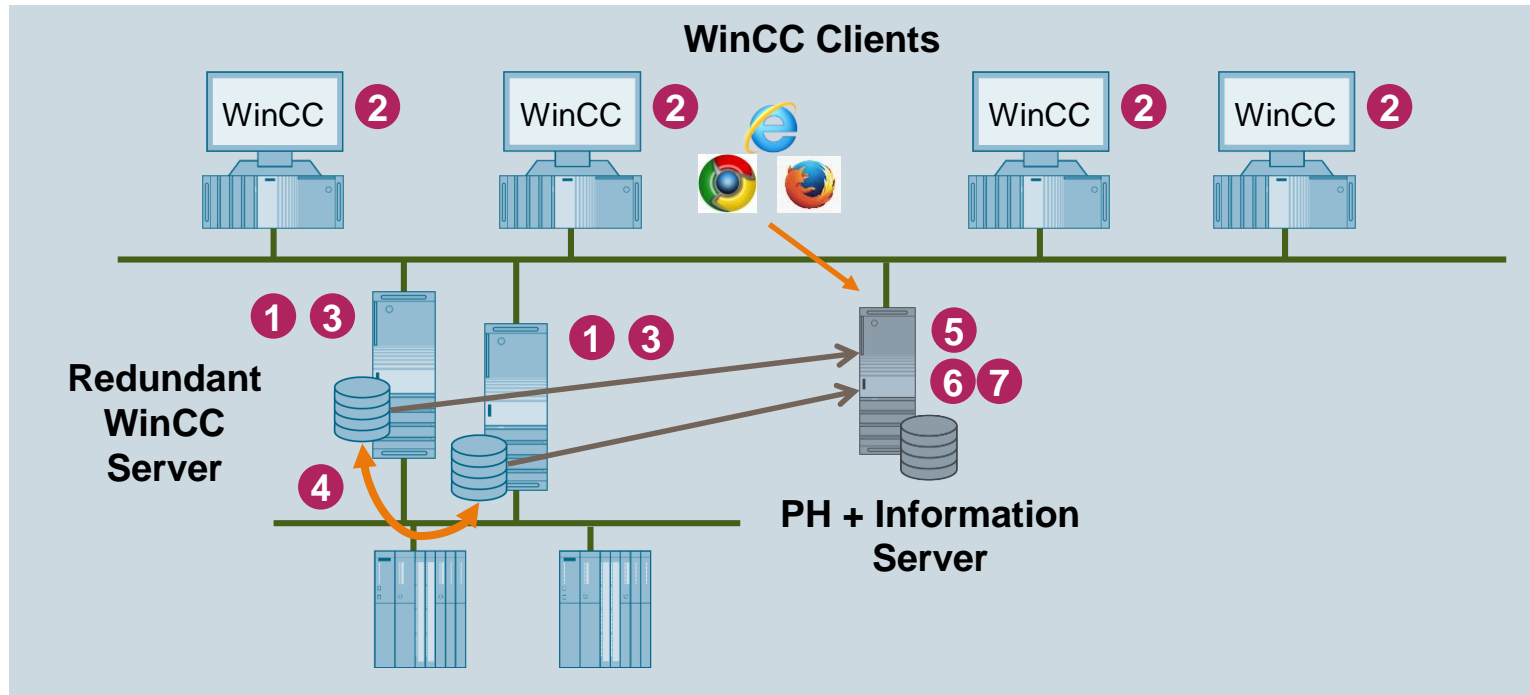

Additional Information

PH and Information Server can be installed on the same computer.
If IS is connected to PH, no "IS DataSource Access" license is needed.

1 Base Package

WinCC RT Prof n
SIMATIC Net V16

2 WinCC Client

MLFB: 6AV2107-0DB06-0AA0

3 WinCC Server

MLFB: 6AV2107-0EB00-0BB0

4 WinCC Redundancy

MLFB: 6AV2107-0FB00-0BB0

5 Process Historian 2014 SP3 upd4

MLFB: 6AV6361-1AA01-4AA0

6 WinCC IS 2014SP3 Base Package

MLFB: 6AV6361-2AA01-4AA0

7 WinCC IS Client Access (1)

MLFB: 6AV6361-2BD00-0AD0

Single-User Web Server

Remote web client on the Internet/intranet

With Internet Explorer or WinCC ViewerRT

1 – 100 Web Clients

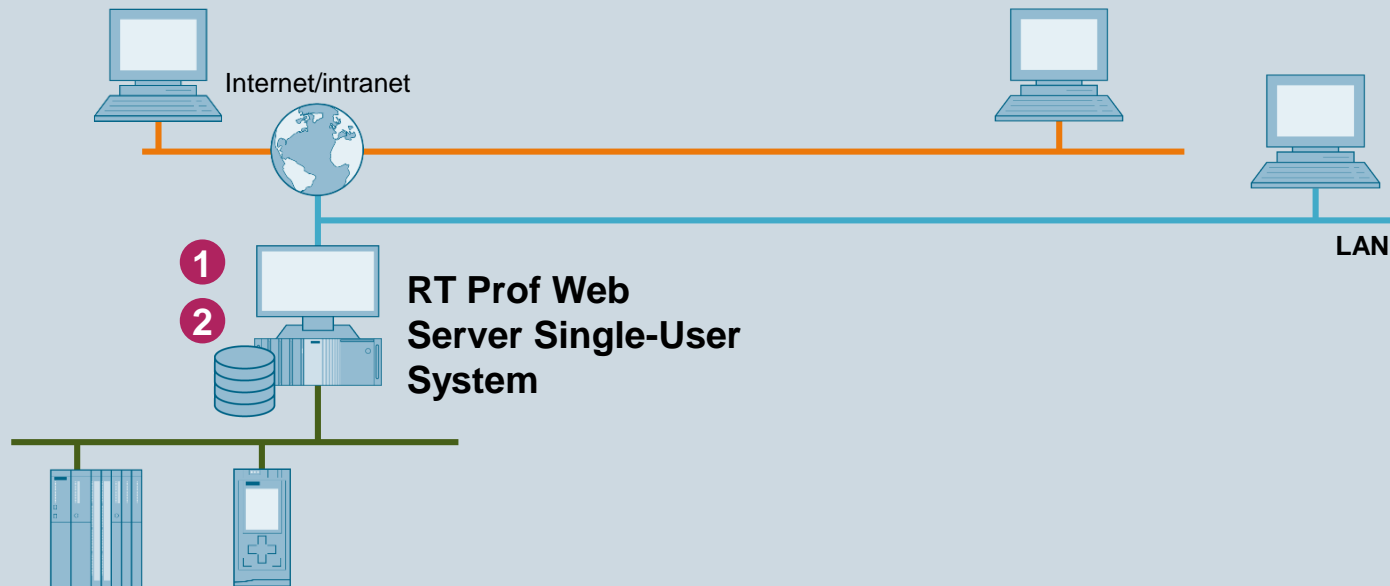

1 Base Package

WinCC RT Prof n
SIMATIC Net V16

2 WinCC WebNavigator

z. B.: for three clients
MLFB: 6AV6362-1AD00-0BB0

Additional Information

WinCC/WebNavigator allows operator control and monitoring from a remote operator station via a local intranet or the Internet.

In each case, a web license for n clients allows a simultaneous connection with the WinCC web server for these n clients

Single-user web server with HTML5 web clients: WebUX allows remote web client on the internet/intranet via tablets/smartphones

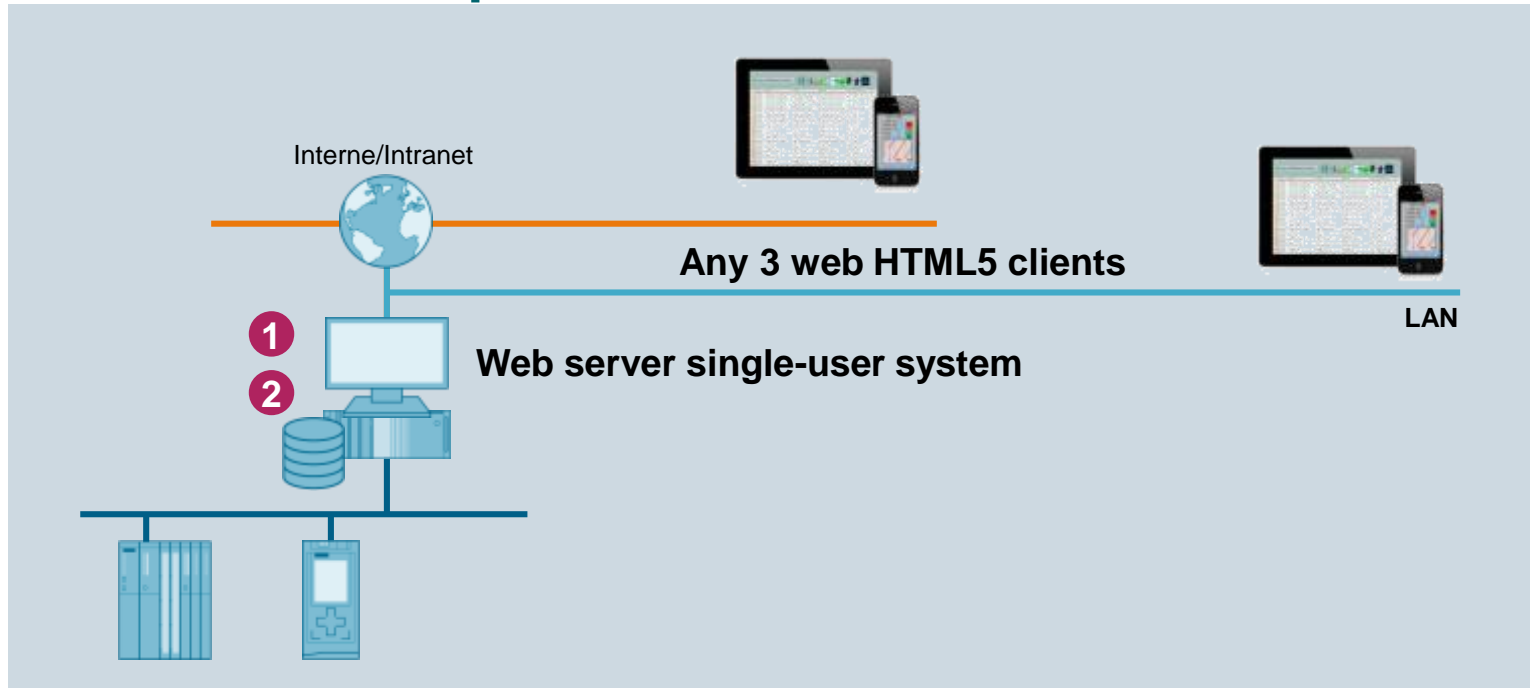

1 Base Package

WinCC RT Prof n
SIMATIC Net V16

2 WinCC WebUX

e.g.: for 3 clients

MLFB: **6AV6362-2BD00-0BB0**

Additional information

In this case, three clients HTML5 can access to the WebUX server without any installation from the client side.

WebUX is based on a secure connection and needs a certificate.

Note: The security certificate must be renewed after one year.

Because of some limitations in comparison to WebNavigator, please verify that WebUX is suitable for the required operations.

Remote diagnostics of WinCC systems in connection with WebNavigator / WebUX - Combined licenses for WebNavigator / WebUX and Diagnostic Client

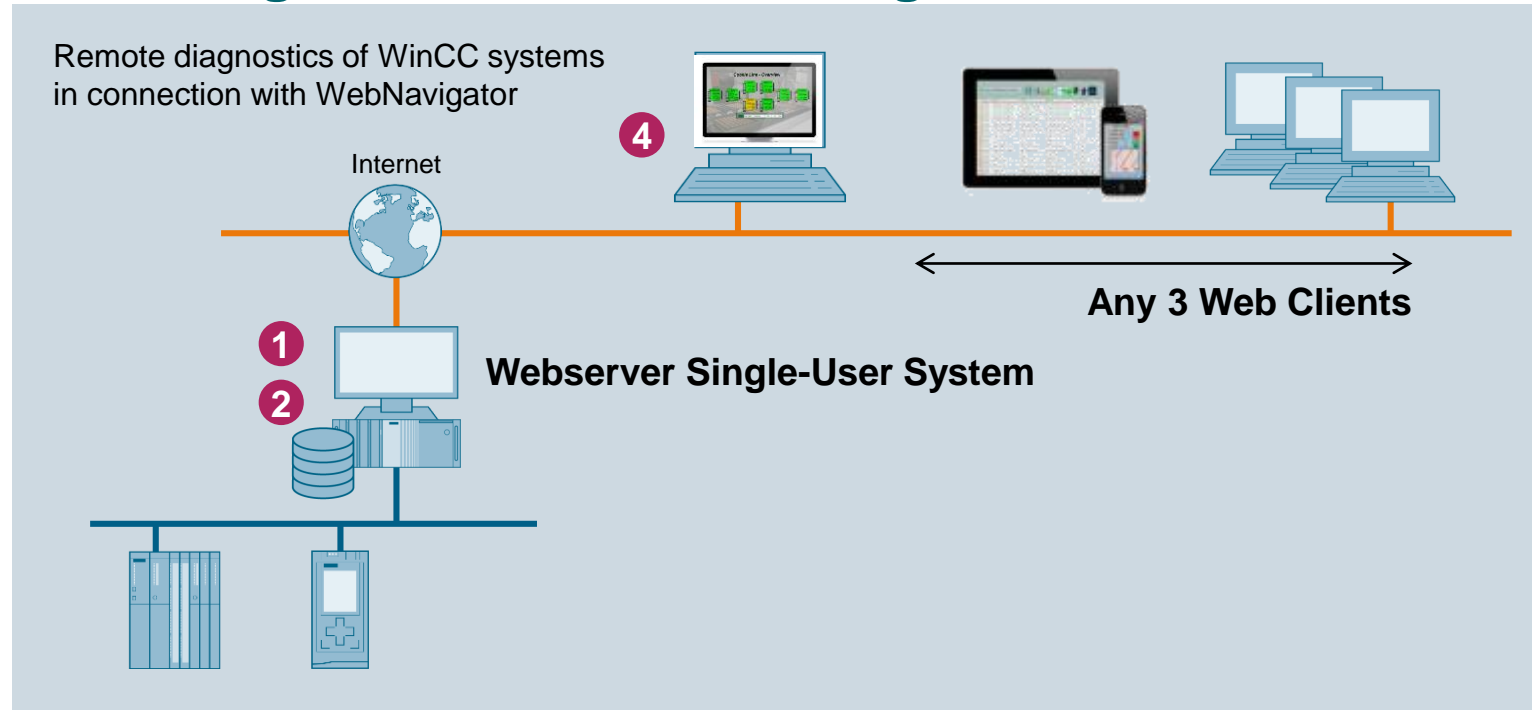

Additional Information

The WebNavigator license can allow the access even from WebUX HTML5 clients combined to WebNavigator desktop clients.
In this case, a WebNavigator license for three clients allows connection from any three WebNavigator/WebUX clients, depending on the configuration.

1 Base Package

WinCC RT Prof n
SIMATIC Net V16

2 WinCC WebNavigator

e. g.: for three Clients
MLFB: **6AV6362-1AD00-0BB0**

3 WinCC WebUX

e. g.: WebUX Operate 3 Clients
MLFB: **6AV6362-2BD00-0BB0**

4 WinCC WebDiagnostics Client

MLFB: **6AV6362-1BA00-0BB0**

Web server single-user system – Special case with only one web connection (WebNavigator Diagnostics)

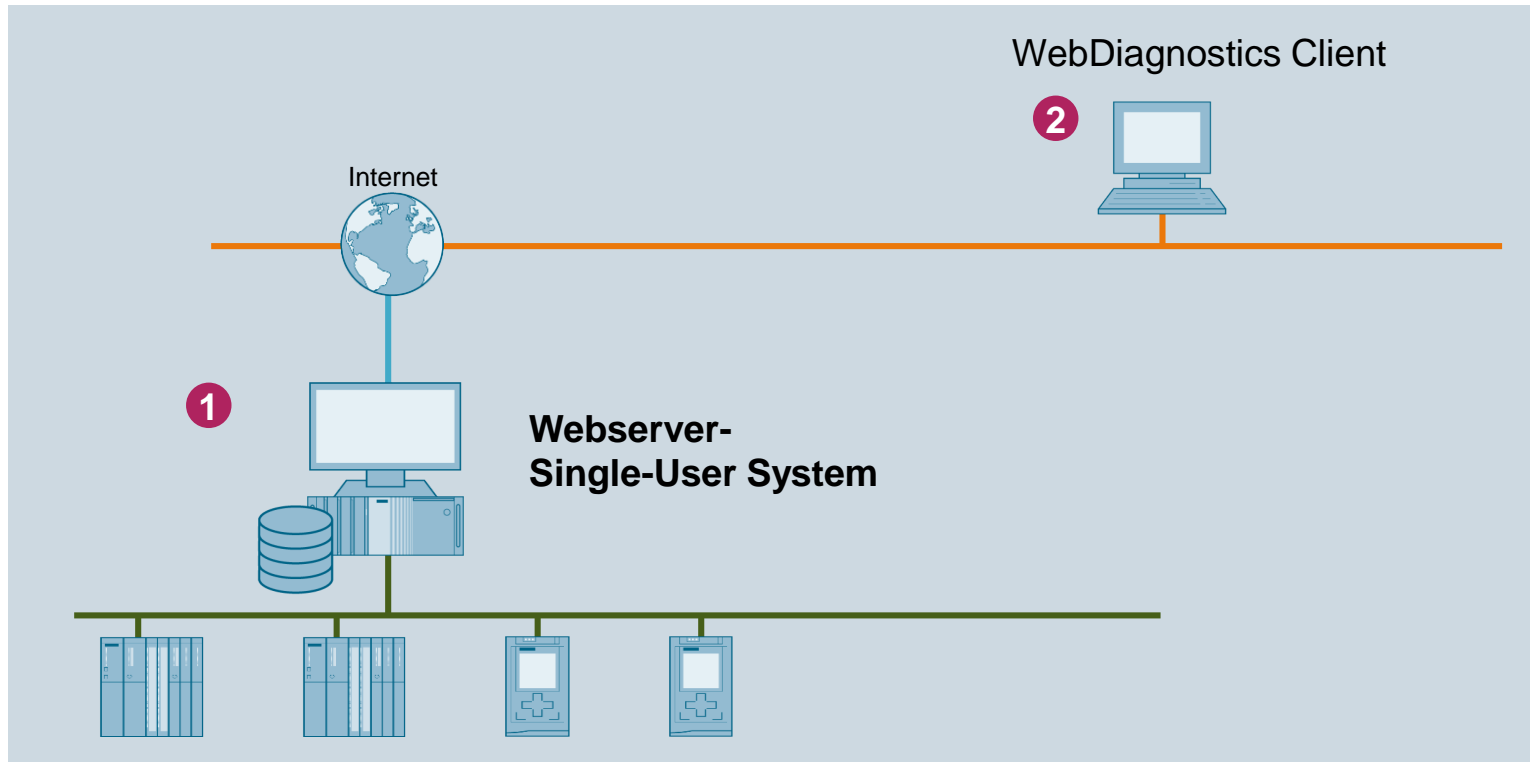

1 Base Package

WinCC RT Prof n
SIMATIC Net V16

2 WinCC WebDiagnostics Client

MLFB: 6AV6362-1BA00-0BB0

Additional Information

In contrast to the preceding case, the license is installed on a web client. Thus, no license is necessary on the server(s) for this client. Several diagnostic clients can be connected to a diagnostics server

Web-Solution 1: Web Solution based on (RDP-Clients) on Industrial Thin Client V3

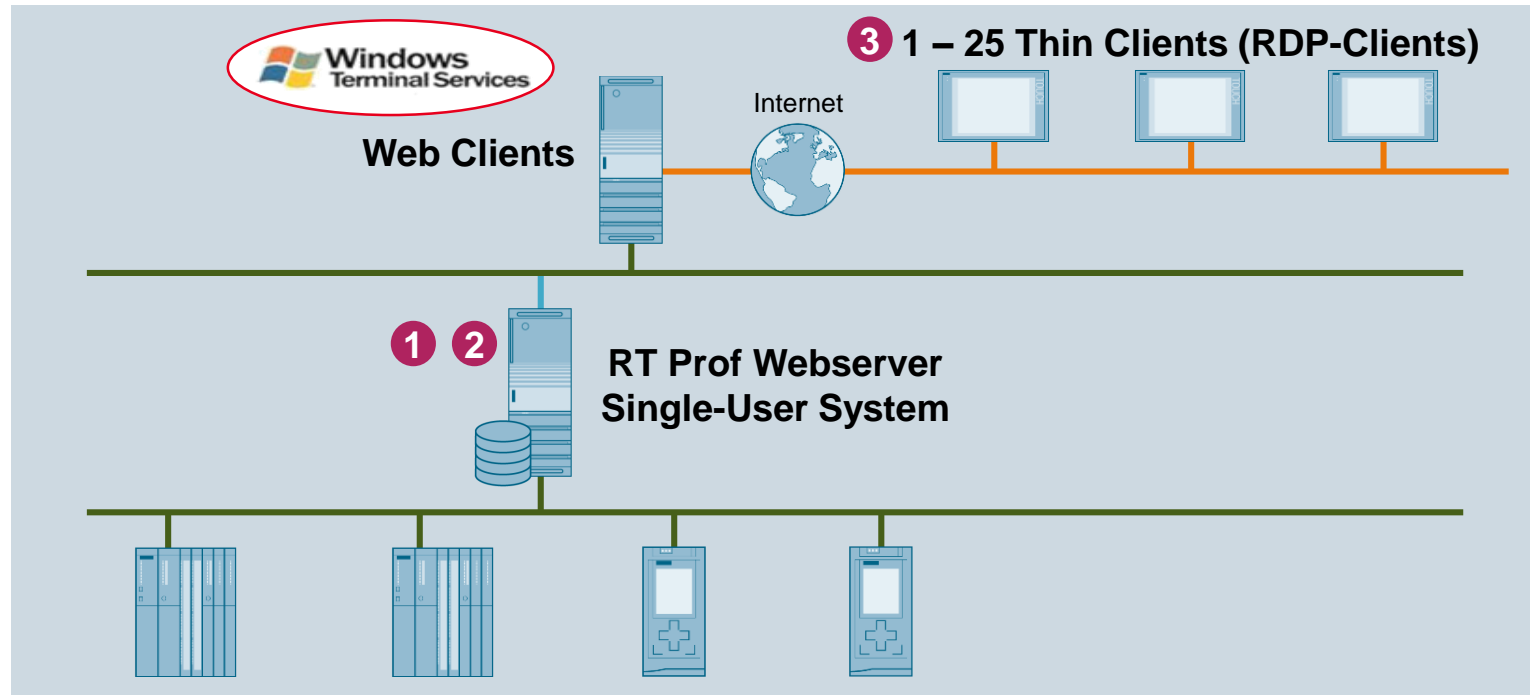

1 Base Package

WinCC RT Prof n
SIMATIC Net V16

2 WinCC WebNavigator

e. g.: for 10 Clients
MLFB: **6AV6362-1AF00-0BB0**

3 Thin Client V3 / Thin Client V3 PRO

6AV6646-1BA15-0AA0	SIMATIC ITC1500 V3
6AV6646-1BA15-0NA0	SIMATIC ITC1500 V3
6AV6646-1BA18-0AA0	SIMATIC ITC1900 V3
6AV6646-1BA18-0NA0	SIMATIC ITC1900 V3
6AV6646-1BA22-1AA0	SIMATIC ITC2200 V3
6AV6646-1BA22-1NA0	SIMATIC ITC2200 V3

With the services of the Windows Terminal Server, the functionalities of the WebNavigator can be used for thin clients (limited resources and operating system not supported by WinCC) Example: SIMATIC Thin Client
The ITC V3 supports the protocols RDP, VNC and Sm@rtserver

<https://support.industry.siemens.com/cs/ww/en/view/109758315>

Web Solution 2: Operator control and monitoring of WinCC systems with HTML 5 browser (Tablet / PC / WebPanel)

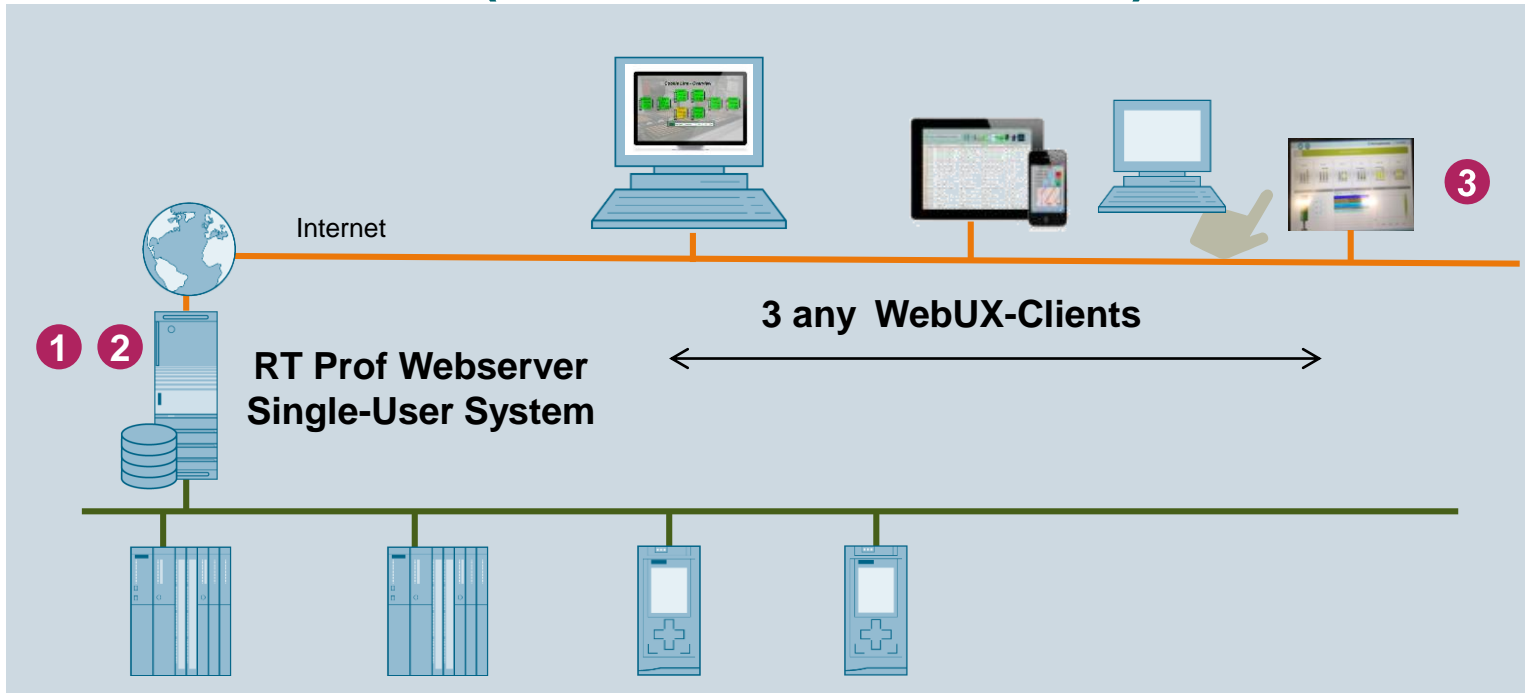

1 Base Package

WinCC RT Prof n
SIMATIC Net V16

2 WinCC WebUX

e. g.: for 10 Clients
MLFB: **6AV6362-1AF00-0BB0**

3 WebPanel

Attention:

Standard ThinClient V3 uses a Mozilla Firefox browser that is not optimal for WebUX

Please order the new WebPanel based on Thin Client V3 with the new Google Chrome browser

Additional Information

WebPanel (Linux based software)

Integrated current **Chromium Browser v66 (perfect for WebUX)**

The IWP software supports different hardware architect (Basic Panels / ITC /IPC

Virtualization for WinCC clients and/or server

Example: Virtual WinCC clients on Hypervisor

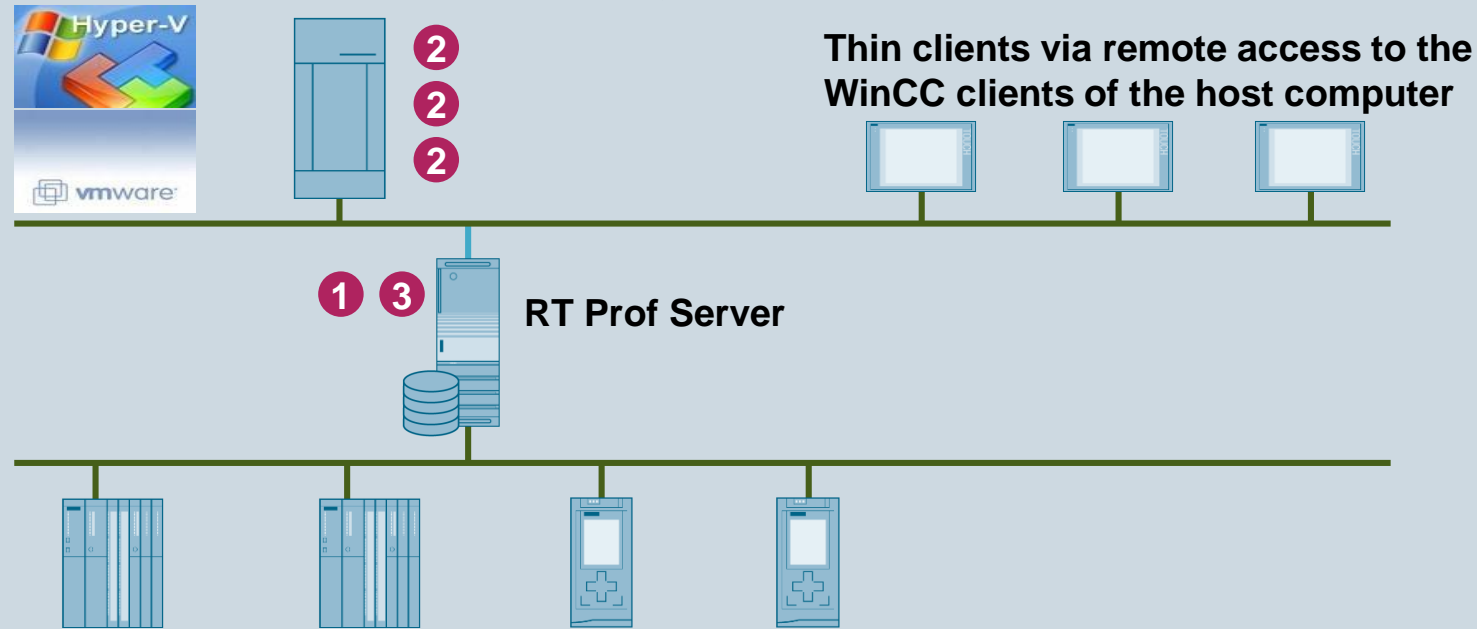

WinCC clients run with the Hypervisor system.

WinCC servers can also be operated using the Hypervisor system.

The maximum number of clients that the virtualization server can host depends on the physical resources of the host computer

- RAM, SSD
- CPU, Number of Core

1 Base Package

WinCC RT Prof n
SIMATIC Net V16

2 WinCC Client

MLFB: 6AV2107-0DB06-0AA0

3 WinCC Server

MLFB: 6AV2107-0EB00-0BB0

Functional differences between WinCC RT Professional V16 and WinCC 7.5 SP1



Functions	WinCC RT Professional V16	WinCC V7.5 SP1
PowerTags	ES: 512, 4k, max. RT: 128, 512, 2k, 4k, 8k, 64k, 100K, 150K, 265k	RC: 128, 512, 2k, 8k, 64k, 100K, 150K, 256k RT: 128, 512, 2k, 8k, 64k, 100K, 150K, 265k
Screens / screen objects	No limit / no limit	No limit / no limit
Alarms	150,000	150,000
	256 alarm classes, 32 types in groups, 17 alarm priorities	256 alarm classes 17 alarm priorities (0 to 16)
Server/client	1 server / 32 clients	18 servers / 64 clients 50 multi-clients
Logging *) 500/ 512 archive tags incl.	Archive tags add. 1,500, 5,000 max. 80,000 (server)	Archive tags add. 1,500, 5,000, 10k, 30k, 80k max. 80,000 (server)
Recipes **)	Recipes: 500 / Elements per recipe: 10 000	Recipes: No limit / Elements per recipe: 100,000
WebNavigator WebUX	1, 3, 10, 30, 100 clients	1, 3, 10, 30, 100 clients (in WinCC V7.3 max.150 clients)
PLC Connections	Up to 128 connections, -max. 128 x S7-1200 / S7-1500 Connections -max. 64 x S7-300 / 400 Connections	128 x S7-1500/ 32 x S7-1200 / 64 x S7-300/400

Functional differences between WinCC RT Professional V16 and WinCC 7.5 SP1

Communication	WinCC Professional V16	WinCC V7.5 SP1
MPI/PROFIBUS	Yes	Yes
OPC UA	OPC UA Server : DA, HA, A&C (Alarm & Condition)	UA Server: DA, HA, A&C (Alarm & Condition)
	OPC UA Client: DA	UA Client: DA, A&C
SIMOTION	OPC UA	Yes
SINUMERIK	NO	Add-on
Allen Bradley	Ethernet/IP	Ethernet/IP
Modicon	Modbus (TCP)	Modbus (TCP)
Mitsubishi	MC TCP/IP	i-QR PLCs
IEC Client	NO	IEC 61850 (Add-on)
DNP3	NO	Option Telecontrol
MQTT	NO	WinCC Cloud Connect

SIMATIC WinCC Professional

Hardware and software from a single source - Order Packages



Package Runtime Licenses		Available SIMATIC IPC
WinCC RT Professional Client	6AV2117-2DB06-0AA0	<p>All SIMATIC IPC</p> <p>Box, Panel, Rack PCs</p>
WinCC RT Professional 128 PT	6AV2115-2BA06-0AA0	
WinCC RT Professional 512 PT	6AV2115-2DA06-0AA0	
WinCC RT Professional 2048 PT	6AV2115-2FA06-0AA0	
WinCC RT Professional 4096 PT	6AV2115-2HA06-0AA0	
WinCC RT Professional 8192 PT	6AV2115-2KA06-0AA0	
WinCC RT Professional 65536 PT	6AV2115-2MA06-0AA0	
		IPC227D and IPC277D







Up to 30% price advantage
(vs. regular WinCC list price)

Available packages for SIMATIC IPC
[SIOS - IPC Packages](#)

Only if ordered simultaneously with the SIMATIC IPC.
Please always observe the operating system requirements of the WinCC system.





Promoter selection help – Software packages for SIMATIC IPCs

[Additional information](#)

	WinCC flexible RT	WinCC RT Advanced	WinCC RT Professional	WinCC V7.x
2x7D/E 	✓	✓	client ✓	client ✓
4x7D 	✓	✓	✓	✓
6x7 / 8x7 C/E 	✓	✓	✓	✓
647 / 847 C/D 	✓	✓	✓	✓
547E/G 	✓	✓	✓	✓
347E 	✓	✓	✓	✓

Promoter selection help – Software packages for SIMATIC IPCs

[Additional information](#)

	WinCC flexible RT	WinCC RT Advanced	WinCC RT Professional	WinCC V7.x	
2x7E 	✓	✓	✗	✓	
377E 	✓	✓	client ✓	client ✓	
ITP1000 	✓	✓	✓	✓	
647 / 847C/D/E 			✓	✓	
127E 			✓	?	(Worked, but not system tested)

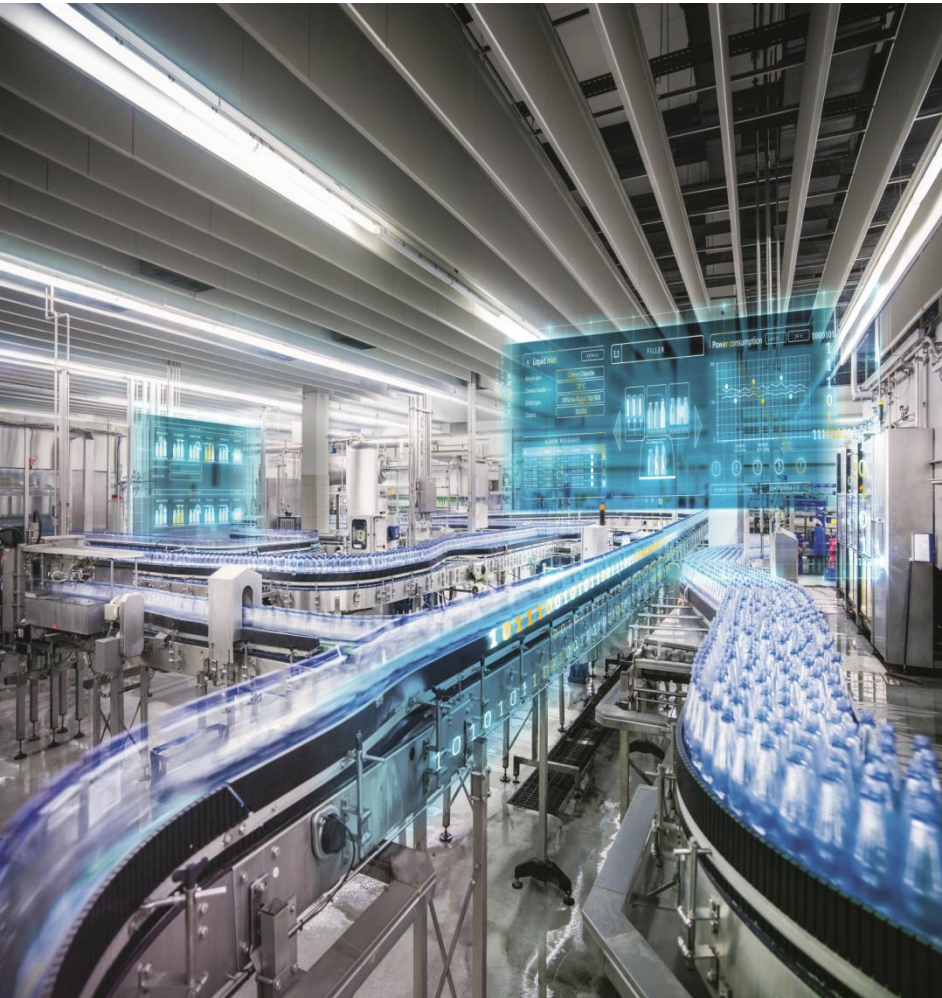

Subject to changes and errors. The information given in this document only contains general descriptions and/or performance features which may not always specifically reflect those described, or which may undergo modification in the course of further development of the products. The requested performance features are binding only when they are expressly agreed upon in the concluded contract.

All product designations, product names, etc. may contain trademarks or other rights of Siemens AG, its affiliated companies or third parties.

Their unauthorized use may infringe the rights of the respective owner.