

Operation Manual

V.34 - Modems

LOGEM® 928
LOGEM® LGM 28.8D1
LOGEM® LGH 28.8D1

© Copyright 1997 ke Kommunikations-Elektronik GmbH & Co.

Technical Status 07/97

Changes may be made without further notice.

Editor:

ke Kommunikations-Elektronik GmbH & Co.

Kabelkamp 20

30179 Hannover/Germany

Phone: ++49 (511) 67 47 - 0

Fax: ++49 (511) 67 47 - 376

Internet: <http://www.ke-online.de>

T-Online: *ke #

Ordering Number: 371 977 46

Attention:

The versions:

LOGEM® 928
(standalone version)

LOGEM® LGM 628.8D1
(rackmounted version)

LOGEM® LGH 28.8D1
(top rail version)

these versions are not specified with their product name at some parts in the manual due to practical reasons. Specific features of the different versions are described separately in the operation manual.



The product meets the rules of the conformity declaration at operational conditions that can be considered as normal use.

1	Modem Description	15
2	Switches Description	33
3	AT Commands	67
4	Register Allocation	105
5	V.25bis Commands	125
6	Dial Backup Features	135
7	Applications	145
8	Appendix	171

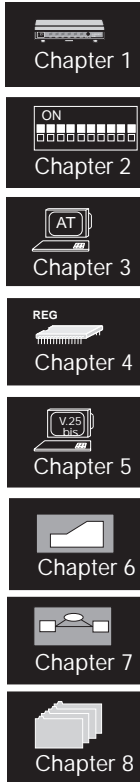

Contents

General	9
Safety Instructions	9
About The Manual	11
1 Modem Description	15
1.1 Transmission Procedures	16
1.2 AT Commands	17
1.3 Compatibility	17
1.4 V.25bis Commands	17
1.5 Automatic Dialing	17
1.6 Data Compression and Data Protection	17
1.7 Password Protection and Callback	18
1.8 Remote Configuration	18
1.9 2/4 Wire Leased Line Operation with Dial Backup	18
1.10 Fax Operation	18
1.11 License	18
1.12 Front Panel LOGEM ® 928	19
1.13 Backpanel LOGEM ® 928	20
1.14 Front Panel LOGEM ® LGM 28.8D1	21
1.15 Side View LOGEM ® LGM 28.8D1	22
1.16 Front Panel LOGEM ® LGH 28.8D1	23
1.17 Top Side LOGEM ® LGH 28.8D1	24
1.18 Connection Example	25
1.19 Installation and Commissioning (Standalone Versions)	26
1.20 Installation and Commissioning (Rackmounted Versions)	27
1.21 Installation and Commissioning (Top Rail Versions)	28
1.22 Loading of Basic Settings	29
1.23 Event Report System	29
2 Switches Description	33
2.1 Table Software/Compatible/Mixed Mode	36
2.1.1 Compatible Mode Switches	37
2.1.1 LGM 1200H1 Operation	38
2.1.2 LGM 2400D2 Operation	40
2.2.1 LOGEM ® 914/LGM 14.4D1 Synchronous/V.25bis	44
2.2.2 LOGEM ® 914/LGM 14.4D1 Asynchronous (software mode/AT and V.25bis)	46

2.2.3	LOGEM ® 928/LGM 28.8D1 Synchronous V.25bis	48
2.2.4	LOGEM ® 928/LGM 28.8D1 Asynchronous (Software mode/AT and V.25bis)	50
2.3	Software Mode Switches Description	52
2.3.1	Loading of Basic Settings 0, 1 or 8	52
2.3.2	Basic Setting 0	53
2.3.3	Basic Setting 1	53
2.3.4	Basic Setting 8 (User Setting 2)	54
2.4	Switches Table Basic Setting 0 (Software Mode)	55
2.4.1	Switches Table Basic Setting 1	56
2.4.2	Switches Table Basic Setting 8 (User Setting 2)	57
2.5	Transmit and Receive Levels (Standalone Versions)	58
2.6	Board of the LOGEM ® 928 (Standalone Version)	59
2.7	Transmit and Receive level (Rackmounted Version)	60
2.8	Board of the LGM 28.8D1	61
2.9	Transmit And Receive Level (Top Rail Version)	62
2.10	Board of the LGH 28.8D1	63
2.11	Country Setting for LGH 28.8D1	64
3	AT Commands	67
3.1	General	67
3.2	Command Description	68
3.3	Telephone and Dialing Features	69
3.3.1	Test Loops	77
3.3.2	Storing and Displaying of Telephone Numbers	78
3.4	Report Codes	79
3.5	Changing of Register Contents	83
3.6	Activation of Control and Report Lines	86
3.7	Data Protection Protocols	89
3.7	BREAK Handling	92
3.8	Handshake	93
3.9	Module Functions	95
3.10	Password Protection	96
3.11	Remote Configuration	100
3.12	Loudspeaker	101
4	Register Allocation	105
4.1	Modem Memory Locations	105
4.2	Register Description	107

5	V.25bis Commands	125
5.1	Reports	125
5.2	Dialing and Telephone Functions	127
5.3	Modem Configuration with V.25bis	131
5.3.1	DNL Command for LGM 1200H1 Operation	132
5.3.2	DNL Command for LGM 2400D2 Operation	132
6	Dial Backup Features	135
6.1	Function of the Dial Backup Board	135
6.2	Installation of the DBU Board (Standalone Version)	135
6.3	Installation of the DBU Board (Rackmounted Version)	138
6.4	Telephone Access Line Selection	139
6.5	Access Line Alternatives	141
7	Applications	145
7.1	Remote Configuration Features	145
7.2	Leased Line Operation (Standalone Version)	151
7.2.1	Leased Line Operation (Rackmounted Version)	152
7.2.2	2 Wire Leased Line	153
7.2.3	4 Wire Leased Line	156
7.2.4	Leased Line Operation with Dial Backup	157
7.2.5	Leased Line Operation with Manual Dial Backup	158
7.3	Leased Line Operation	163
7.4	Lightning and Overvoltage Protection	167
8	Appendix	171
	Appendix A	171
	Appendix B1 Connection to a TAE 6NF Socket	174
	Appendix B2 Telephone Access Jacks	175
	Appendix B3 Telephone Access Jacks	176
	Appendix B4 Telephone Access Jacks	177

Appendix B3	
Telephone Access Cable RJ12/TAE 6N	178
Appendix B4	
Telephone Access Cable FKS8/TAE 6N	179
Appendix C1	
Data Interface LGM 28.8D1	180
Appendix C2	
Interfaces LGM 28.8D1	181
Appendix C3	
V.24 Interface Allocations	182
Appendix C4	
Asynchronous Standard Connection Connection	183
Appendix C5	
Synchronous Standard Connection	184
Appendix C7	
Modem to Modem Cross Cable (asynchronous)	185
Appendix C6	
Allocation of the 25pole Sub D Jack	185
Appendix C8	
Modem Identification	186
Appendix D	
ASCII Table	187
Appendix E	
Glossary	188
Appendix F	
Technical Data	191
Appendix G	
Index	193



General

Safety Instructions



Please read the following safety instructions carefully. They are ment for your own safety and for faultless function of your devices:

- Electronical devices are sensitive for electrostatical charges. Deflect any electrostatical charges before touching the board with your hands or tools.
- Disable the power supply before removing the housing (standalone) or the casing of the rackmounted versions.
- Boards may be only extracted after any connections have been removed.
- Make sure that other units you are going to connect to your device meet all specifications.

About The Manual

This manual presents the features of the modems concerning all functions and meaning of the DIP switches as well as the operational elements and the command language.



1	Modem Description.....	15
1.1	Transmission Procedures	16
1.2	AT Commands	17
1.3	Compatibility	17
1.4	V.25bis Commands	17
1.5	Automatic Dialing	17
1.6	Data Compression and Data Protection	17
1.7	Password Protection and Callback	18
1.8	Remote Configuration	18
1.9	2/4 Wire Leased Line Operation with Dial Backup	18
1.10	Fax Operation	18
1.11	License	18
1.12	Front Panel LOGEM® 928	19
1.13	Backpanel LOGEM® 928	20
1.14	Front Panel LOGEM® LGM 28.8D1	21
1.15	Side View LOGEM® LGM 28.8D1	22
1.16	Front Panel LOGEM® LGH 28.8D1	23
1.17	Top Side LOGEM® LGH 28.8D1	24
1.18	Connection Example	25
1.19	Installation and Commissioning (Standalone Versions)	26
1.20	Installation and Commissioning (Rackmounted Versions)	27
1.21	Installation and Commissioning (Top Rail Versions)	28
1.22	Loading of Basic Settings	29
1.23	Event Report System	29





1 Modem Description

The *LOGEM*[®] 928 is a high speed standalone modem for duplex operation that supports all conventional modulation procedures. The *LOGEM*[®] LGM 28.8D1 has identical features and comes as a rackmounted version while the *LOGEM*[®] LGH 28.8D1 is the version for top rail installation.

The modems support the operation modes listed below:

- V.34
- V.32bis
- V.32
- V.22bis
- V.22
- V.23dx
- V.21
- V.17, V.29, V.27ter (only for fax operation)

Data transmission is possible with synchronous or asynchronous procedures. The modems are designed for operation on switched and leased lines as well. Software configuration is performed using AT, V.25bis or DNL commands, DIP switches are available for hardware configuration. As an option an additional board for 2/4 wire leased line operation with dial backup feature is available thus providing a second line interface. Data protection protocols acc. to V.42bis and MNP4 are implemented for the transmission procedures acc. to ITU-T V.34, V.32bis, V.32, V.22bis and V.21 thus allowing for almost errorless data transmission between to terminal equipments. Due to the implementation of data compression methods acc. to V.42bis and MNP5 data transmission rate may increase up to the factor 4 (max. 115200 bit/s).

Safety aspects are taken into consideration starting with the dial up. At activated password protection any caller is only put through to the terminal equipment (i.e. a host) after typing the correct password.

With an additional callback number a connection is terminated after the correct password has been transferred and the modem dials the callback number. A connection to a host is only switched when the connection has been established successfully during the callback procedure.

The modems even cooperate with terminal equipment that might not be able to transfer dial commands. The operation mode "direct call" allows for dialing of a predefined calling number just by switching the control line S1/DTR from OFF to ON.

As a further feature the modems are designed for remote configuration as direct or local modem configuration is not possible at some applications, i.e. a terminal is not available or the operation mode of different remote modems has to be altered. The modems from the *LOGEM*

product line even allow for reconfiguration during an existing connection. Three operation modes are available for different modem applications.

During software mode all modem configurations are performed using AT or V.25bis commands. AT commands should be preferred generally as V.25bis commands do not allow to set any registers. The command phase is always asynchronous during utilization of AT commands. After dial up data transmission is performed according to the selected synchronous or asynchronous modulation procedure.

Compatible mode is employed to emulate duplex operation mode for existing recent modems. Here the necessary modem is selected using the DIP switches. The first 14 switches of the modem correspond to the switches of the modem to be replaced. For this reason a terminal is not necessary for modem configuration.

During mixed mode the modem operates with the AT mode but some registers have to be selected with DIP switches as they are blocked for software access.

1.1 Transmission Procedures

The modems operate with the ITU-T recommendations listed below:

- V.34 (2400 bit/s, 4800 bit/s, 7200 bit/s, 9600 bit/s, 12000 bit/s, 14400 bit/s, 16800 bit/s, 19200 bit/s, 21600 bit/s, 24000 bit/s, 26800 bit/s, 28800 bit/s, duplex) synchronous and asynchronous
- V.32bis (14400 bit/s and 12000 bit/s, duplex) asynchronous and synchronous
- V.32 (4800 bit/s, 7200 bit/s und 9600 bit/s, duplex) asynchronous and synchronous
- V.22bis (2400 bit/s, duplex) synchronous and asynchronous
- V.22 (1200 bit/s, duplex) synchronous and asynchronous
- V.23 (75/1200 bit/s, 1200/75 bit/s, asymmetrical duplex) asynchronous
- V.21 (300 bit/s, duplex) asynchronous
- V.17, V.29, V.27ter (14400 bit/s, 12000 bit/s, 9600 bit/s, 4800 bit/s, 2400 bit/s, halfduplex) send and receive fax

1.2 AT Commands

The AT command set is an international standard developed by the US modem manufacturer Hayes. During command mode any modem commands or modem reports are transferred asynchronously to the data terminal equipment (DTE).

A command line has to start with an AT. The modems feature an integrated automatic baud rate detection (up to 57600bit/s) that may be deactivated.

1.3 Compatibility

The modems described here are functionally compatible to the duplex operation modes of the models LGM 1200H1 and LGM 2400D2.

1.4 V.25bis Commands

The ITU-T recommendation is an international standard for automatic dialing during synchronous or asynchronous operation modes.

1.5 Automatic Dialing

The modems come with an integrated automatic dialing feature for data connections that may be controlled using either the V.25bis or the AT command set. An integrated memory for calling numbers is included as well. The dialing can be performed with pulse or tone (multi frequency) dialing procedures.

Attention!



After data transmission the receiver must be onhook as the connection remains operational at full charges otherwise.

1.6 Data Compression and Data Protection

To prevent from data transmission errors on low quality telephone lines the modems can utilize the V.42 protocol or the Microcom Networking Protocol MNP 4 during the operation modes acc. to V.32bis, V.32, V.22, V.22bis and V.21. As an addition data compression is possible with MNP5 or V.42bis protocols.

1.7 Password Protection and Callback

The modems provide password protection with four operation modes that may be combined freely (with/without callback and released callback/forced callback). Max. 20 callback numbers are protected individually with a password. Any alterations are protected using a super password. A register counts wrong passwords thus providing a hacker protection.

1.8 Remote Configuration

The modems are designed for remote configuration. A connection can be setup e.g from a remote station to the modem. The remote configuration can be initiated just by typing a special password.

1.9 2/4 Wire Leased Line Operation with Dial Backup

i This feature is only available for the standalone and rackmounted versions!

A special board for 2/4 wire leased line operation with dial backup feature is available as an option. Max. 20 backup numbers may be stored. During failures on the leased line the modem calls the stored backup numbers until it is able to initiate a switched line connection. In the meantime the modem checks the leased line constantly and reswitches automatically if the leased line is operational again.

1.10 Fax Operation

The fax option of the modems allows for sending and receiving faxes with a special fax software that should be installed on your computer (e.g.: RVS-Com for Windows, WinFax Pro 3.0). The fax option is compatible to:

- ITU-T (CCITT) group 3 (Rec. G3)
- TIA/EIA CLASS 2

1.11 License

The modems are licensed for operation in public and private networks by the national german licensing authorities.

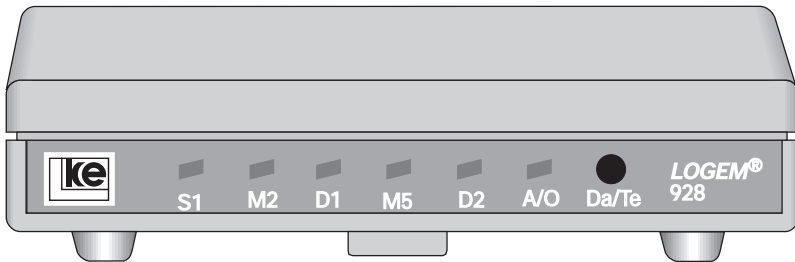
1.12 Front Panel *LOGEM*® 928

Element	Description
S1 (LED)	State of interface line S1 ON: DTE is operational
M2 (LED)	State of interface line M2 ON: DCE ready to transmit
D1 (LED)	State of interface line D1 OFF: no DTE connected Green: DTE is active Red: DTE transmits data
M5 (LED)	State of interface line M5 ON: carrier detected
D2 (LED)	State of interface line D2 Green: DCE is active RED: receive data
A/O (LED)	State of interface line A/O ON: answer (upper channel)
Da/Te (button)	data/test button

1.13 Backpanel LOGEM® 928

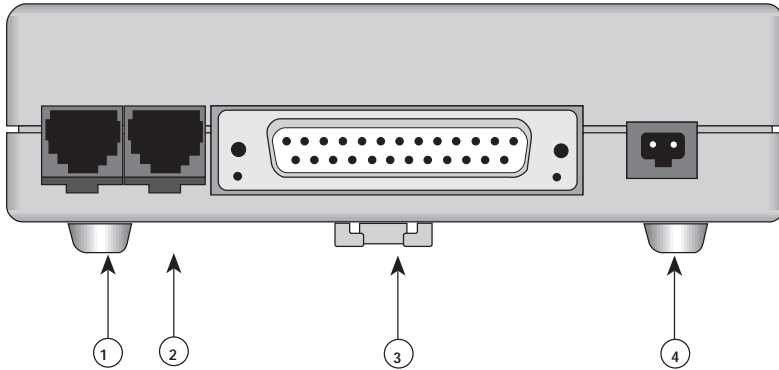

Element	Description
1	telephone access jack (RJ12) for dial line and 2 wire leased line
2	RJ12 jack for 2/4 wire leased line via DBU board (optional)
3	25pole sub D jack (acc.to ITU-T V.24/V.28)
4	power supply connector (2pole) for power supply cable of the external adapter

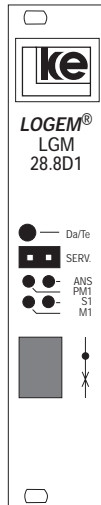
1.14 Front Panel *LOGEM*® LGM 28.8D1

Element	Description
Da/Te (button)	data/test button
SERV. (conn.)	earphone connector
ANS (LED)	indicates channel allocation Blinks: modem occupies the line
PM1 (LED)	State of interface line PM1 ON: test activated
S1 (LED)	State of interface line S1 ON: DTE is ready
M1 (LED)*	State of interface line M1 ON: modem is ready
FKS8 (jack)	telephone access jack

* A special modem version displays M5 (instead of M1). Here M5 = ON means that a carrier was detected (DCD).

1.15 Side View *LOGEM*® LGM 28.8D1

Chapter 1



Element	Description
S1 (switch)	DIP switches SET 1/1 ... SET 1/10
S2 (switch)	DIP switches SET 2/1 ...SET 2/4
S3 (switch)	DIP switches SET 3/1 ... SET 3/6 (bottom)

1.16 Front Panel *LOGEM*® LGH 28.8D1

Element	Description
D1 (LED)	State of interface line D1/TxD ON: receives data from DTE
S1 (LED)	State of interface line S1/DTR Yellow: DTE operational
LB (LED)	ON: active during line access
D2 (LED)	State of interface line D2/RxD ON: transmits data to DTE
M2 (LED)	State of interface line M2/CTS Yellow: DCE ready to receive
M5 (LED)	State of interface line M5/DCD Yellow: during existing connection

1.17 Top Side *LOGEM*® LGH 28.8D1



1.18 Connection Example

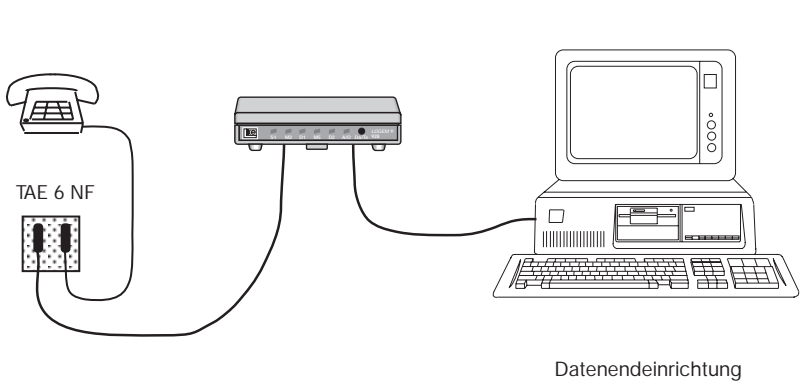

1.19 Installation and Commissioning (Standalone Versions)

The items listed below are necessary for commissioning of the **LOGEM**[®] 928:

- a telephone access
- a telephone access jack TAE 6, coding N
- a data terminal equipment (PC, terminal, ...)

Proceed the installation step by step following the information listed below:

1. Deactivate your DTE and all other peripheral equipment (printer, etc.).
2. Set the DIP switches at your device as necessary.
3. Connect the V.24 interface cable to the serial output of your DTE (V.24/V.28 or RS 232C) and the V.24 jack of your modem.
4. Connect the telephone access cable with the modem and the TAE 6 N jack.
5. Connect the power supply adapter with your modem and plug the adapter into the power supply socket. Now the LED D2 indicates green. The **LOGEM**[®] 928 performs a self test.
6. Now activate your DTE and all other peripheral equipment.
7. Install and/or activate your data communication software.

Safety Instructions:

- Protect your modem against direct sun radiation!
- Do not cover the ventilation slots of your modem!

1.20 Installation and Commissioning (Rackmounted Versions)

The items listed below are necessary for commissioning of the **LOGEM**[®] LGM 28.8D1:

- a telephone access
- a telephone access jack TAE 6, coding N
- a data terminal equipment (PC, terminal, ...)

Proceed the installation step by step following the information listed below:

1. Deactivate your DTE and all other peripheral equipment (printer, etc.).
2. Set the DIP switches at your device as necessary.
3. Install the modem into your communications system or switching box.
4. Connect the telephone access cable with the modem and the TAE6 N jack.
5. Now connect the V.24 jack of your modem with the DTE. This is performed directly via the 96pole connector (Attention: the V.24 interface has TTL levels) or using an interface switching with level conversion from V.24/TTL to V.24/V.28 (RS 232C).
6. Now activate your DTE and all other peripheral equipment.
7. Install and/or activate your data communication software.



1.21 Installation and Commissioning (Top Rail Versions)

The items listed below are necessary for commissioning of the **LOGEM**[®] LGH 28.8D1:

- a telephone access
- a telephone access jack TAE 6, coding N
- a data terminal equipment (PC, terminal, ...)

Proceed the installation step by step following the information listed below:

1. Deactivate your DTE and all other peripheral equipment (printer, etc.).
2. Set the DIP switches at your device as necessary.
3. Connect the V.24 interface cable to the serial output of your DTE (V.24/V.28 or RS 232C) and the 25pole jack of your modem.
4. Connect the telephone access cable with the modem and the TAE6 N jack.
5. Now connect your modem with the 24 V DC operating voltage. The LGH 28.8D1 performs a self test.

Attention!

The LGH 28.8D1 may only be operated with a power supply that corresponds to EN 60950.

6. Now activate your DTE and all other peripheral equipment.
7. Install and/or activate your data communication software.

1.22 Loading of Basic Settings

If you have any doubts concerning modem configuration during AT mode and the modem seems not to accept any commands coming from the DTE you can restore the basic setting without a terminal just by pressing the button Da/Te during modem startup.

The basic setting selected with the switches S2.6 ... S2.10 is stored to the RAM or the RAM and the EEPROM of the modem dependent from the duration of the period your press the Da/Te button. The basic setting is stored only to the RAM if you release the button when the LED A/O or LB (top rail version) lights up. The setting is stored to the EEPROM if you press the button until the LED A/O or LB blinks.

Attention: This procedure is **not** applicable during mixed and compatible mode!

1.23 Event Report System

Attention: The event report system is not available for the top rail versions of the modems!

The modems feature an intelligent event report system that may be implemented for monitoring of private premises (heating systems, water level indicator, ...), or as an alarm system (window broken, burglary, ...), or to monitor industrial machinery (water levels, fire alarms, ...).

This operation mode is available with software version 4.0. Alarm reports are transferred using the four alarm inputs of the modem. According to the configuration the modem calls the communication services listed below that can be accessed freely in any combination necessary:

- **Fax Message**
The modem converts the preset label and the report text to the fax format and transfers the data to a conventional fax machine.
- **Citycall Message**
The preset report text is transferred to the citycall provider that calls the citycall pager and sends the information.
- **Modem Message**
Label and report text are transferred in ASCII format using a standard modem to a central (i.e. fire brigade). There the data can be displayed on a monitor, printed on a serially connected printer or processed by a software.



2	Switches Description	33
2.1	Table Software/Compatible/Mixed Mode	36
2.1.1	Compatible Mode Switches	37
2.1.1	LGM 1200H1 Operation	38
2.1.2	LGM 2400D2 Operation	40
2.2.1	LOGEM ® 914/LGM 14.4D1 Synchronous/V.25bis ...	44
2.2.2	LOGEM ® 914/LGM 14.4D1 Asynchronous (software mode/AT and V.25bis)	46
2.2.3	LOGEM ® 928/LGM 28.8D1 Synchronous V.25bis ...	48
2.2.4	LOGEM ® 928/LGM 28.8D1 Asynchronous (Software mode/AT and V.25bis)	50
2.3	Software Mode Switches Description	52
2.3.1	Loading of Basic Settings 0, 1 or 8	52
2.3.2	Basic Setting 0	53
2.3.3	Basic Setting 1	53
2.3.4	Basic Setting 8 (User Setting 2)	54
2.4	Switches Table Basic Setting 0 (Software Mode)	55
2.4.1	Switches Table Basic Setting 1	56
2.4.2	Switches Table Basic Setting 8 (User Setting 2)	57
2.5	Transmit and Receive Levels (Standalone Versions) ..	58
2.6	Board of the LOGEM ® 928 (Standalone Version)	59
2.7	Transmit and Receive level (Rackmounted Version) ..	60
2.8	Board of the LGM 28.8D1	61
2.9	Transmit And Receive Level (Top Rail Version)	62
2.10	Board of the LGH 28.8D1	63
2.11	Country Setting for LGH 28.8D1	64

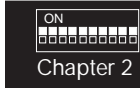

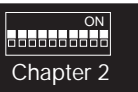

2 Switches Description

The **LOGEM**® 928 and the **LOGEM**® LGH 28.8D1 feature 20 DIP switches in two blocks with 10 switches each (S1.1 ... S1.10 and S2.1 ... S2.10).

The **LOGEM**® LGM 28.8D1 features 20 DIP switches in three blocks with 10, 4 and 6 switches (S1.1 ... S1.10, S2.1 ... S2.4 and S3.1 ... S3.6).

The setting of the DIP switches S2.6 ... S2.10 i.e. S3.2 ... S3.6 for the rackmounted version defines the meaning of the other switches S1 and S2.1 ... S2..

The switches tables shown on the coming sides operate with double head lines. The upper line presents the DIP switches of the standalone and top rail versions. The second line (with grey shading) presents the DIP switches of the rackmounted version.



S2.6	S2.7	S2.8	S2.9	S2.10	Operation Mode: LGM 1200H1
S3.2	S3.3	S3.4	S3.5	S3.6	
ON	OFF	ON	OFF	ON	

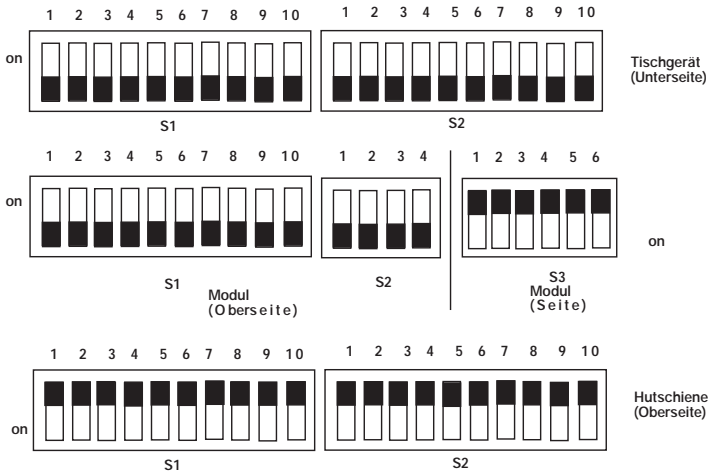

The modems feature special settings for three different operation modes:

Compatible Mode

If you have selected one of the compatible mode settings the switches S1.1 ... S2.4 correspond to the switches of the modem to be emulated. If you have selected the modem type to be emulated the setting of all other DIP switches can be kept. Then the modems operate as the modem selected but they do support only duplex operation modes.

During compatible mode the button Da/Te must not be pressed during POWER ON to select the operation mode.

Software Mode

During software mode (basic setting 0 ... 8) only the DIP switches S2.2 ... S2.10 are active. All further configurations are software selected. You can operate with two preset factory defaults and one basic setting that may be altered. The preset factory settings are stored in the nonvolatile and uneraseable ROM. The basic setting that may be defined freely can be stored in a specially protected area of the EEPROM by the user. This is a user defined basic setting that is stored with the command AT&W2. After storing this configuration is to be regarded as a basic setting.

Mixed Mode

The modems are in software mode during this operation mode but some register contents and AT commands have to be set using the DIP switches. This allows for modem configuration without a terminal for asynchronous or synchronous operation.

If you press the Da/Te button during POWER ON the basic setting is loaded without interpreting the DIP switches. If you press the button until the LED A/O, ANS or LB blinks the setting is copied to the EEPROM as well. To make the configuration of the DIP switches active you must now deactivate the modem and switch it ON again.

The mixed mode allows for operation with error correction and data compression as well.

The commands and registers listed here can not be altered with an command during mixed mode:

F(n), &L(n), &F(n), &M(n), \N(n), \Q(n), &D(n), %R(n), &H(n), SET(n)=x, S0, S52, S60 and S80.

This procedure guarantees for DIP switches settings not to be altered by AT commands.

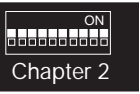

Attention:

If you have selected the operation mode leased line M1+ the command phase is deactivated automatically (ref. to AT command AT&B) as well as the escape character "+". The interface line M2/CTS is not active during the offline phase. Further internal configurations suppress the character echo and the modem reports. Any characters coming from the terminal equipment are ignored during offline phase.

Loading of a basic setting during software mode

A basic setting has to be preset before activation of the operation voltage of the mode using the switches S2.6 ... S2.10 or S3.2 ... S3.6. This selected preset is stored if you press the Da/Te button and activate the operating voltage. The setting is stored in the RAM if you press the button until the LED A/O, ANS or LB lights up. If you press the button until the LED blinks the setting is stored in the EEPROM as well. This guarantees that the setting stays intact even after a voltage breakdown and reactivation of the operating voltage.

This procedure is only applicable for the basic settings 0 ... 8. The settings for compatible mode are activated directly after POWER ON.

Generation of an user setting

The modems allow for generating a user specific basic setting which is normally a modification of one of the basic settings 0 ... 7 for a special application. If such an alteration is only stored with the command AT&W it might be overwritten in some cases.

Using the command AT&W2 allows for saving of generated user settings as a basic setting. For safety reasons the user is requested for his acknowledgement. Then the configuration is stored in a protected part of the EEPROM. Now you can recall this set of parameters with the switches S2.6 ... S2.10 or S3.2 ... S3.6 as basic setting 8. A modem that is set up in such a manner may be applied anywhere without any other peripheral devices as the user configuration can be loaded just by pressing the Da/Te button during startup.

Basic settings of the modems:

Basic setting 0*	V.34, V.42bis operation, btx operation with transmission rates > 2400 bit/s possible, AT commands, autobaud, asynchronous
Basic setting 1	V.22bis btx operation, AT commands, 2400 bit/s asynchronous
Basic setting 2...7	...
Basic setting 8	The user setting stored with AT&W2. This setting corresponds to the basic setting 0 in delivery state, but remote configuration is still possible.

* delivery state

2.1 Table Software/Compatible/Mixed Mode

	compatible mode	mixed mode	software mode
V.25bis sync.	●		
V.25bis async.	●	○	○
AT commands (async.)		○	●
define own user setting			●
password protection			●
direct call	○		●
leased line async. (no data prot. protocol)	●		○
leased line async. (data prot. protocol)		○	●
leased line sync.	●		○
leased line* with dial backup			●

* This operation is only possible if the modem is equipped with the optional board for 2/4 wire dial backup.

This feature is not available for the top rail versions!

- possible operation mode
- recommended operation mode

During compatible and mixed mode the modems allow for configuration without a terminal using the DIP switches.

During software mode settings are performed using AT commands.

2.1.1 Compatible Mode Switches

If you have selected one of the compatible mode settings (DIP switches S2.6 S2.10 or S3.2 ... S3.6) the switches S1.1 ... S2.4 correspond to the switches of the selected modem. Thus the setting of the first14 DIP switches of the modem to emulated can be kept. Then the compatible mode can be selceted using the last 5 DIP switches of the modem.

The DIP switches have to be set before activation of the operating voltage as the parameters necessary for this operating mode are only read out at POWER ON.



2.1.1 LGM 1200H1 Operation

S1.1	S1.2	S1.3	transmission rate *
OFF	OFF	OFF	1200 bit/s hx, V.23, asyn.
ON	OFF	OFF	1200 bit/s hx, V.23 with clock + SYNC change
OFF	ON	OFF	1200 bit/s hx, no SYNC change
ON	ON	OFF	idle
OFF	OFF	ON	idle
ON	OFF	ON	300 bit/s dx, V.21 constant carrier
OFF	ON	ON	300 bit/s, S2 (RTS) controlled
ON	ON	ON	300 bit/s, S2-M2 (RTS-CTS) simulation

S1.4	S1.5	S1.6	operation mode
OFF	OFF	OFF	S1.2 operation (outg. autom. dialing, inc. autom. switching with answer tone)
ON	OFF	OFF	S1.2 operation (outg. manual dialing, inc. autom. switching with answer tone)
OFF	ON	OFF	leased line (M1 + direct switching)
ON	ON	OFF	direct call (outg. dir. dialing via interface S1/DTR)
OFF	OFF	ON	S1.2 operation (outg. autom. dialing, inc. manual switching with answer tone)
ON	OFF	ON	S1.2 operation (outg. manual dialing, inc. manual switching with answer tone)
OFF	ON	ON	S1.2 operation (outg. manual dialing, inc. manual switching with answer tone)
ON	ON	ON	S1.1 operation, leased line via S1/DTR

S1.7	S1.8	S1.9	protocol for automatic dialing
OFF	OFF	OFF	asynchr. start - stop
ON	OFF	OFF	sync. bitoriented ASCII
OFF	ON	ON	sync. byteoriented ASCII
ON	ON	OFF	sync. bitoriented EBCDIC
OFF	OFF	ON	sync. byteoriented EBCDIC
ON	OFF	ON	sync. bitoriented ASCII/NRZI
OFF	ON	ON	sync. bitoriented EBCDIC/NRZI
ON	ON	ON	idle

S1.10	channel allocation (only for V.21)
S1.10	
OFF	transmit channel allocation B, receive channel allocation A
ON	transmit channel allocation A, receive channel allocation B

S2.1	hx: carrier delay	S2.1	at V.21: channel alloc.*
S2.1		S2.1	
OFF	~ 22 ms	OFF	autom.
ON	V.23 ~30 ms; V.21 ~200 ms	ON	acc. to S1.10

S2.2	equalizer *
S2.2	
OFF	on
ON	off

S2.3	S2.4	only for dx operation
S2.3	S2.4	
OFF	OFF	no deactivation
ON	OFF	no deactivation
OFF	ON	after 250 ms
ON	ON	after 10s

S2.5	dialing procedure
S3.1	
OFF	pulse
ON	tone

S2.6	S2.7	S2.8	S2.9	S2.10	operation mode: LGM 1200H1
S3.2	S3.3	S3.4	S3.5	S3.6	
ON	OFF	ON	OFF	ON	

* During software mode these functions are selected using the command ATSET(n)=x.



2.1.2 LGM 2400D2 Operation

S1.1	transmission procedure
S1.1	
OFF	asynchronous
ON	synchronous

S1.2	S1.3	format V.25bis sync.	S1.2	S1.3	data format. asyn.
S1.2	S1.3		S1.2	S1.3	
OFF	OFF	bitoriented ASCII	OFF	OFF	10 bit/character
ON	OFF	byteoriented ASCII	ON	OFF	9 bit/character
OFF	ON	bitoriented EBCDIC	OFF	ON	8 bit/character
ON	ON	byteoriented EDCDIC	ON	ON	11 bit/character

S1.4	S1.5	S1.6	operation mode
S1.4	S1.5	S1.6	
OFF	OFF	OFF	S1.2 operation (outg. autom. dialing, inc. autom. switching with answer tone)
ON	OFF	OFF	S1.2 operation (outg. manual dialing, inc. autom. switching with answer tone)
OFF	ON	OFF	leased line (M1 + direct switching)
ON	ON	OFF	direct call (outg. dir. dialing via interface S1/DTR)
OFF	OFF	ON	S1.2 operation (outg. autom. dialing, inc. manual switching with answer tone)
ON	OFF	ON	S1.2 operation (outg. manual dialing, inc. manual switching with answer tone)
OFF	ON	ON	S1.2 operation (outg. manual dialing, inc. manual switching with answer tone)
ON	ON	ON	S1.1 operation, leased line via S1/DTR

S1.7	S1.8	clock source at synchr. operation
S1.7	S1.8	
OFF	OFF	transm. clock int. (T2, 114)
ON	OFF	transm. clock from receive clock (T4, 114)
OFF	ON	transm. clock ext. (T1, 113), (ignored at ISDN op.)
ON	ON	idle

S1.9	S1.10	transmission rate *
S1.9	S1.10	
OFF	OFF	via interface line S4/114
ON	OFF	2400 bit/s, permanently set
OFF	ON	1200 bit/s, permanently set
ON	ON	idle

S2.1	leased line channel alloc. at operation without answer tone	S2.2	dialing procedure
OFF	calling mode		pulse
ON	answer mode		tone

S2.3	V.25bis	S2.4	S2/CTS control
S2.3	comm. echo	S2.4	
OFF	no echo	OFF	perm. ON
ON	echo	ON	from DTE

S2.5	autom. deactivation at carrier loss
S3.1	
OFF	after 10s
ON	after 250 ms

S2.6	bitrate tolerance "overspeed"
S3.2	
OFF	+1%/-2.5%
ON	+2.3%/2.5%

S2.7	guardtone
S3.3	
OFF	off
ON	1800 Hz

S2.8	carrier at const. connection
S3.4	
OFF	constant ON
ON	controlled (S2/RTS)

S2.6	S2.7	S2.8	S2.9	S2.10	operation mode: LGM 2400D2
S3.2	S3.3	S3.4	S3.5	S3.6	
X	X	X	ON	ON	

* During software mode these functions are selected using the command ATSET(n)=x.

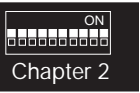

2.2 Mixed Mode Switches

Some parameters are selected using DIP switches during mixed mode operation. Further parameters can be adjusted with AT commands. To avoid any collision between AT commands and DIP switches the commands listed below are blocked during mixed mode operation. During synchronous mode operation AT commands are not available as it employs generally V.25bis commands only.

List of blocked AT commands for asynchronous mixed mode:

command/register	used by DIP switch
ATF / S50	S1.1 ... S1.3 modulation procedure
AT&D	S1.4 ... S1.6 DTR option
S0	S1.4 ... S1.6 autom. call acception
AT&L	S1.4 ... S1.6 line switching
S80	S1.4 ... S1.6 command language (AT or V.25bis)
AT\N	S1.7 ... S1.9 error correction procedure
S60	S1.7 ... S1.9 data format for direct mode
AT\Q	S1.10 data flow control
S51	S2.1 ... S2.2 DTE rate
AT&H	S2.4 hx simulation
ATT / ATP	S2.5 pulse / tone dialing



2.2.1 LOGEM® 914/LGM 14.4D1 Synchronous/V.25bis

S1.1	S1.2	S1.3	transmission rate (bit/s)
S1.1	S1.2	S1.3	
OFF	OFF	OFF	14400 bit/s/auto (V.32bis, V.32, V22bis, V.22)
ON	OFF	OFF	14400 bit/s/V.32bis
OFF	ON	OFF	12000 bit/s/V.32bis
ON	ON	OFF	9600 bit/s/V.32
OFF	OFF	ON	7200 bit/s/V.32
ON	OFF	ON	4800 bit/s/V.32
OFF	ON	ON	2400 bit/s/V.22bis
ON	ON	ON	1200 bit/s/V.22

S1.4	S1.5	S1.6	operation mode
S1.4	S1.5	S1.6	
OFF	OFF	OFF	S1.2 operation (outg. autom. dialing, inc. autom. switching with answer tone)
ON	OFF	OFF	S1.2 operation (outg. manual dialing, inc. autom. switching with answer tone)
OFF	ON	OFF	leased line (M1 + direct switching)
ON	ON	OFF	direct call (outg. dir. dialing via interface S1/DTR)
OFF	OFF	ON	S1.2 operation (outg. autom. dialing, inc. manual switching with answer tone)
ON	OFF	ON	S1.2 operation (outg. manual dialing, inc. manual switching with answer tone)
OFF	ON	ON	S1.2 operation (outg. manual dialing, inc. manual switching with answer tone)
ON	ON	ON	S1.1 operation, leased line via S1/DTR

S1.7	S1.8	S1.9	protocol for automatic dialing
S1.7	S1.8	S1.9	
OFF	OFF	OFF	sync. byteoriented ASCII
ON	OFF	OFF	sync. bitoriented ASCII
OFF	ON	ON	sync. byteoriented EBCDIC
ON	ON	OFF	sync. bitoriented EBCDIC
OFF	OFF	ON	async. ASCII 8 data bits
ON	OFF	ON	sync. bitoriented ASCII/NRZI
OFF	ON	ON	sync. bitoriented EBCDIC/NRZI
ON	ON	ON	AS400 operation

leased line operation (M1+, S1.1):			
S1.7	S1.8	S1.9	leased line operation mode
S1.7	S1.8	S1.9	
OFF	OFF	OFF	2 wire via dial line interface
ON	OFF	OFF	2 wire via dial backup board*
OFF	ON	OFF	4 wire via dial backup board*

S1.10	channel allocation for leased line operation		
S1.10			
OFF	answer		
ON	originate		

S2.1	S2.2	clock variant	
S2.1	S2.2		
OFF	OFF	transmit clock internally T2/T4	
ON	OFF	transmit clock receiver T2=T4	
OFF	ON	transmit clock externally T1/T4	
ON	ON	---	

S2.3	rate change		
S2.3			
OFF	off		
ON	on		

S2.4	hx simulation		
S3.1			
OFF	off		
ON	on		

S2.5	dialing procedure		
S3.1			
OFF	pulse		
ON	tone		

S2.6	S2.7	S2.8	S2.9	S2.10	operation mode: synchronous
S3.2	S3.3	S3.4	S3.5	S3.6	LOGEM [®] 914
ON	ON	OFF	OFF	ON	LGM 14.4D1

* Not for top rail versions!



2.2.2 LOGEM® 914/LGM 14.4D1 Asynchronous (software mode/AT and V.25bis)

S1.1	S1.2	S1.3	transmission rate (bit/s)
S1.1	S1.2	S1.3	
OFF	OFF	OFF	14400 bit/s/auto (V.32bis, V.32, V22bis, V.22)
ON	OFF	OFF	14400 bit/s/V.32bis
OFF	ON	OFF	12000 bit/s/V.32bis
ON	ON	OFF	9600 bit/s/V.32
OFF	OFF	ON	7200 bit/s/V.32
ON	OFF	ON	4800 bit/s/V.32
OFF	ON	ON	2400 bit/s/V.22bis
ON	ON	ON	1200 bit/s/V.22

S1.4	S1.5	S1.6	operation mode
S1.4	S1.5	S1.6	
OFF	OFF	OFF	S1.2 operation (outg. autom. dialing, inc. autom. switching with answer tone)
ON	OFF	OFF	S1.2 operation (outg. manual dialing, inc. autom. switching with answer tone)
OFF	ON	OFF	S1.2 operation (outg. autom. dialing, inc. manual switching with answer tone)
ON	ON	OFF	S1.2 operation (outg. manual dialing, inc. manual switching with answer tone)
OFF	OFF	ON	
ON	OFF	ON	
OFF	ON	ON	leased line, switching channel alloc. A (originator)
ON	ON	ON	leased line, switching channel alloc. B (answer)

S1.7	S1.8	S1.9	error correction procedure/data format
S1.7	S1.8	S1.9	
OFF	OFF	OFF	autoreliable mode
ON	OFF	OFF	reliable mode (not for V.23)
OFF	ON	OFF	reliable mode V42bis (no V.21 and V.23 operation)
ON	ON	OFF	reliable mode (no V.23 operation)
OFF	OFF	ON	normal mode
ON	OFF	ON	direct mode 9 bit/character
OFF	ON	ON	direct mode 10 bit/character
ON	ON	ON	direct mode 11 bit/character

S1.10	data flow control (not during direct mode)*	
S1.10		
OFF	hardware, RTS/CTS (S2/M2)	
ON	software, XON/XOFF	

S2.1	S2.2	DTE rate for normal and reliable mode
S2.1	S2.2	
OFF	OFF	autobaud for AT commands (default: 9600 bps)
OFF	ON	9600 bit/s
OFF	ON	19200 bit/s
ON	ON	38400 bit/s

S2.3	rate change **
S2.3	
OFF	off
ON	on

S2.4	hx simulation
S3.1	
OFF	off
ON	on

S2.5	dial line	S2.5	leased line
S3.1	dialing procedure	S3.1	with DBU***
OFF	pulse	OFF	2 wire leased line
ON	tone	ON	4 wire leased line

S2.6	S2.7	S2.8	S2.9	S2.10	operation mode: asynchronous
S3.2	S3.3	S3.4	S3.5	S3.6	LOGEM [®] 914
ON	OFF	OFF	OFF	ON	LGM 14.4D1

* During direct mode the DTE rate corresponds to the modulation procedure selected with S1.1 ... S1.3.

*** During direct mode the switch determines if the selected modulation procedure (S1.1 ...S1.3) may be changed during retrains.

*** **Not for top rail versions!**



2.2.3 LOGEM[®] 928/LGM 28.8D1 Synchronous V.25bis

S1.1	S1.2	S1.3	transmission rate (bit/s)
OFF	OFF	OFF	28800 bit/s/auto (V.34bis,V32bis, V.32, V22bis, V.22)
ON	OFF	OFF	28800 bit/s/V.34
OFF	ON	OFF	26400 bit/s/V.34
ON	ON	OFF	24000 bit/s/V.34
OFF	OFF	ON	21600 bit/s/V.34
ON	OFF	ON	19200 bit/s/V.34
OFF	ON	ON	16800 bit/s/V.34
ON	ON	ON	14400 bit/s/V.34

S1.4	S1.5	S1.6	operation mode
OFF	OFF	OFF	S1.2 operation (outg. autom. dialing, inc. autom. switching with answer tone)
ON	OFF	OFF	S1.2 operation (outg. manual dialing, inc. autom. switching with answer tone)
OFF	ON	OFF	leased line (M1 + direct switching)
ON	ON	OFF	direct call (outg. dir. dialing via interface S1/DTR)
OFF	OFF	ON	S1.2 operation (outg. autom. dialing. inc. manual switching with answer tone)
ON	OFF	ON	S1.2 operation (outg. manual dialing, inc. manual switching with answer tone)
OFF	ON	ON	S1.2 operation (outg. manual dialing, inc. manual switching with answer tone)
ON	ON	ON	S1.1 operation, leased line via S1/DTR

S1.7	S1.8	S1.9	protocol for automatic dialing
OFF	OFF	OFF	sync. byteoriented ASCII
ON	OFF	OFF	sync. bitoriented ASCII
OFF	ON	ON	sync. byteoriented EBCDIC
ON	ON	OFF	sync. bitoriented EBCDIC
OFF	OFF	ON	async, ASCII 8 data bits
ON	OFF	ON	sync. bitoriented ASCII/NRZI
OFF	ON	ON	sync. bitoriented EBCDIC/NRZI
ON	ON	ON	AS400 operation

leased line operation (M1+, S1.1):			
S1.7	S1.8	S1.9	leased line operation mode
S1.7	S1.8	S1.9	
OFF	OFF	OFF	2 wire via dial line interface
ON	OFF	OFF	2 wire via dial backup board**
OFF	ON	OFF	4 wire vial dial backup board**

S1.10	channel allocation for leased line operation
S1.10	
OFF	answer
ON	originate

S2.1	S2.2	clock variant
S2.1	S2.2	
OFF	OFF	transmit clock internally T2/T4
ON	OFF	transmit clock receiver T2=T4
OFF	ON	transmit clock externally T1/T4
ON	ON	---

S2.3	rate change*
S2.3	
OFF	off
ON	on

S2.4	hx simulation
S3.1	
OFF	off
ON	on

S2.5	dialing procedure
S3.1	
OFF	pulse
ON	tone

S2.6	S2.7	S2.8	S2.9	S2.10	operation mode: synchronous
S3.2	S3.3	S3.4	S3.5	S3.6	LOGEM® 928
OFF	ON	OFF	OFF	ON	LGM 28.8D1

* During direct mode the switch determines if the selected modulation procedure (S1.1 ...S1.3) may be changed during retrains.

** Not for top rail versions!

2.2.4 LOGEM® 928/LGM 28.8D1 Asynchronous (Software mode/AT and V.25bis)

S1.1	S1.2	S1.3	transmission rate (bit/s)
S1.1	S1.2	S1.3	
OFF	OFF	OFF	28800 bit/s/auto (V.34bis,V32bis, V.32, V22bis, V.22)
ON	OFF	OFF	28800 bit/s/V.34
OFF	ON	OFF	26400 bit/s/V.34
ON	ON	OFF	24000 bit/s/V.34
OFF	OFF	ON	21600 bit/s/V.34
ON	OFF	ON	19200 bit/s/V.34
OFF	ON	ON	16800 bit/s/V.34
ON	ON	ON	14400 bit/s/V.34

S1.4	S1.5	S1.6	operation mode
S1.4	S1.5	S1.6	
OFF	OFF	OFF	S1.2 operation (outg. autom. dialing, inc. autom. switching with answer tone)
ON	OFF	OFF	S1.2 operation (outg. manual dialing, inc. autom. switching with answer tone)
OFF	ON	OFF	S1.2 operation (outg. autom. dialing, inc. manual switching with answer tone)
ON	ON	OFF	S1.2 operation (outg. manual dialing, inc. manual switching with answer tone)
OFF	OFF	ON	leased line, switching channel alloc. A via DBU***
ON	OFF	ON	leased line, switching channel alloc. B via DBU***
OFF	ON	ON	leased line, switching channel alloc. A (originator)
ON	ON	ON	leased line, switching channel alloc. B (answer)

S1.7	S1.8	S1.9	error correction procedure/data format
S1.7	S1.8	S1.9	
OFF	OFF	OFF	autoreliable mode
ON	OFF	OFF	reliable mode (not for V.23)
OFF	ON	OFF	reliable mode V42bis (no V.21 and V.23 operation)
ON	ON	OFF	reliable mode (no V.23 operation)
OFF	OFF	ON	normal mode
ON	OFF	ON	direct mode 9 bit/character
OFF	ON	ON	direct mode 10 bit/character
ON	ON	ON	direct mode 11 bit/character

S1.10	data flow control (not during direct mode)	
S1.10		
OFF	hardware, RTS/CTS (S2/M2)	
ON	software, XON/XOFF	

S2.1	S.2.2	DTE rate for normal and reliable mode*
S2.1	S2.2	
OFF	OFF	autobaud for AT commands (default: 38400 bps)
OFF	ON	38400 bit/s
OFF	ON	57600 bit/s
ON	ON	115200 bit/s

S2.3	rate change**	
S2.3		
OFF	off	
ON	on	

S2.4	hx simulation	
S3.1		
OFF	off	
ON	on	

S2.5	dial line	S2.5	leased line
S3.1	dialing procedure	S3.1	with DBU***
OFF	pulse	OFF	2 wire leased line
ON	tone	ON	4 wire leased line

S2.6	S2.7	S2.8	S2.9	S2.10	operation mode: asynchronous
S3.2	S3.3	S3.4	S3.5	S3.6	LOGEM [®] 928
ON	OFF	OFF	OFF	ON	LGM 28.8D1

* During direct mode the DTE rate corresponds to the modulation procedure selected with S1.1 ... S1.3.

** During direct mode the switch determines if the selected modulation procedure (S1.1 ...S1.3) may be changed during retrains.

*** **Not for top rail versions!**

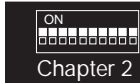

2.3 Software Mode Switches Description

Any configurations during software mode are performed using AT commands. The generated user setting may be stored permanently in the EEPROM with the command AT&W(n) (n=0...2).

The modems feature three different predefined configurations for the software mode that are stored in the ROM. These configurations can be loaded during POWER ON using the DIP switches. The settings 0, 1 and 8 are predefined from a maximum of 9 basic settings to be defined.

	S2.6	S2.7	S2.8	S2.9	S2.10
	S3.2	S3.3	S3.4	S3.5	S3.6
basic setting 0	OFF	OFF	OFF	OFF	OFF
basic setting 1	ON	OFF	OFF	OFF	OFF
basic setting 8	OFF	OFF	OFF	ON	OFF

The basic setting 8 is the user setting 2. The setting is predefined and stored in the EEPROM but it may be altered by the user. The altered version can be reloaded later using the DIP switches.

2.3.1 Loading of Basic Settings 0, 1 or 8

If you are not certain concerning the modem setting or wish to load one of the basic settings this is possible at POWER ON as any other configuration that might be stored in the EEPROM is erased during startup. Any stored short dial numbers or passwords are not erased. Please refer to the list below:

1. Deactivate the operating voltage of your modem.
2. Select a basic setting using the DIP switches.
3. Press the button Da/Te and hold it down.
4. Activate the operating voltage with the button still pressed down.
5. Wait until the LED A/O, ANS or LB lights up. If you release the button now the new setting is transferred to the ROM. The modem is now operational. Any EEPROM configurations have not been overwritten.
6. If you press the Da/Te button until the LED A/O, ANS or LB blinks the new configuration is written to the EEPROM as well. Any recent settings are overwritten.

Attention!

This procedure is only applicable for loading of the basic settings described here.

2.3.2 Basic Setting 0

In delivery state the modems come with basic setting 0. All DIP switches are in OFF position.

Connection:	dial line
Operation mode:	automatical detection of modulation (V.22 ... V.34)
DTE interface:	autom. detection of transmission rate at 8 data bits, no parity
Data protection:	normal mode (MNP or V.42 is possible)
Data compression:	active (MNP5 or V.42bis)
Data flow control:	hardware (RTS/CTS)
Call acception:	after first ring
Command phase:	AT command
Command echo:	On
Reports:	On, text reports
misc.:	password protection and remote servicing deactivated

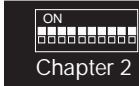

2.3.3 Basic Setting 1

Here DIP switch S2.6 (S3.2) is in ON position and all other switches are in position OFF to load the basic setting 1.

Connection:	dial line
Operation mode:	V.22bis (2400 bit/s)
DTE interface:	2400 bit/s at 8 data bits, no parity
Data protection:	direct mode
Data compression:	not possible
Data flow control:	hardware (RTS/CTS)
Autom. call acc.:	deactivated
Command phase:	AT commands
Command echo:	On
Reports:	On, text reports
misc.:	password protection and remote servicing deactivated

2.3.4 Basic Setting 8 (User Setting 2)

Here DIP switch S2.9 (S3.5) is ON and all other switches are in position OFF to select basic setting 8.

This setting may be overwritten with AT&W2. This allows for generating of an individual default setting that can be recalled using the DIP switches.



Connection:	dial line
Operation mode:	automatical detection of modulation (V.22 ... V.34)
DTE interface:	autom. detection of transmission rate at 8 data bits, no parity
Data protection:	normal mode (MNP or V.42 is possible)
Data compression:	active (MNP5 or V.42bis)
Data flow control:	hardware (RTS/CTS)
Call acception:	after first ring
Command phase:	AT command
Command echo:	On
Reports:	On, text reports
misc.:	remote servicing acvtivated, DTR is being ignored

2.4 Switches Table Basic Setting 0 (Software Mode)

Switches

S2.6	S2.7	S2.8	S2.9	S2.10
S3.2	S3.3	S3.4	S3.5	S3.6
OFF	OFF	OFF	OFF	OFF

autom. detection of modulation procedure, V.42bis, btx operation with transmission rates > 2400 bit/s possible, AT commands, autobaud, asynchronous

F255 E1 L1 M1 Q0 X4 V1 P \Q2 \G0 \A1 \C3 \L0 \N3 \X0 \K3 \B3 %C1 %E1 %M0 %R0 &L0 &I0 &X0 &G0 &M0 &C2 &D2 &H0 &R1 &S1 &T5

S00=001 S01=000 S02=043 S03=013 S04=010 S05=008 S07=100
 S08=002 S10=050 S12=045 S20=255 S26=004 S28=000 S37=000
 S39=017 S40=019 S45=000 S50=255 S51=255 S54=001 S60=000
 S61=000 S62=030 S63=006 S64=001 S65=004 S66=016 S67=000
 S80=000 S81=000 S90=005 S91=001 S100=042 S101=000
 S102=000

The modems operate with automatic detection of the modulation procedure at the transmission side during this asynchronous setting. Towards the DTE the modem operates with automatic detection of the transmission rate (autobaud) towards the data terminal equipment (DTE). The data format is set to 1 start bit, 8 data bits, no parity and 1 stop bit.

The ITU-T protocols V.42 and V.42bis are activated for safe data transmission. If the remote modem does not support data protection protocols the modems proceed with normal mode operation. Modem reports are transferred as text documents to the DTE. During command mode (AT commands) any characters are transferred as an echo to the DTE.



2.4.1 Switches Table Basic Setting 1

Switches

S2.6	S2.7	S2.8	S2.9	S2.10
S3.2	S3.3	S3.4	S3.5	S3.6
OFF	OFF	OFF	OFF	OFF

V.22bis, btx, AT commands, 2400 bit/s, asynchronous

F3 E1 L1 M1 Q0 X4 V1 P \Q2 \G0 \A1 \C0 \L0 \N1 \X0 \K0 \B3 %C1 %E1
%M0 %R0 &L0 &I0 &X0 &G0 &M0 &C2 &D2 &R1 &H0 &S0 &T5

S00=000 S01=000 S02=043 S03=013 S04=010 S05=008 S07=100
S08=002 S10=004 S12=045 S20=255 S26=004 S28=000 S37=000
S39=017 S40=019 S45=000 S50=003 S51=004 S54=001 S60=000
S61=000 S62=030 S63=006 S64=001 S65=004 S66=016 S67=000
S80=000 S81=000 S90=005 S91=001 S100=042 S101=000
S102=000

This basic setting allows for btx operation of the modems with 2400 bit/s. The data protection protocols are deactivated and the modem operates in direct mode. During command phase the modems operate with AT commands.

2.4.2 Switches Table Basic Setting 8 (User Setting 2)

Switches

S2.6	S2.7	S2.8	S2.9	S2.10
S3.2	S3.3	S3.4	S3.5	S3.6
OFF	OFF	OFF	OFF	OFF

autom. detection of modulation procedure, V.42bis, btx operation with transmission rates > 2400 bit/s possible, AT commands, autobaud, asynchronous

F255 E1 L1 Q0 X4 V1 P \Q2 \G0 \A1 \C3 \L0 \N3 \X0 \K3 \B3 %C1 %E1 %M0 %R0 &L0 &I0 &X0 &G0 &M0 &C2 &D0 &H0 &R1 &S1&T5

S00=001 S01=000 S02=043 S03=013 S04=010 S05=008 S07=100
 S08=002 S10=050 S12=045 S20=255 S26=004 S28=000 S37=000
 S39=017 S40=019 S45=001 S50=255 S51=255 S54=001 S60=000
 S61=000 S62=030 S63=006 S64=001 S65=004 S66=016 S67=000
 S80=000 S81=000 S90=005 S91=001 S100=042 S101=000 S102=000

In delivery state the basic setting 8 is identical to basic setting 0. As an addition remote configuration is possible (register S45=1) and the modem is operational without the control line S1(108). Using the command AT&W2 these values can be overwritten to generate an individual basic setting.

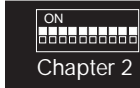





2.5 Transmit and Receive Levels (Standalone Versions)



Transmit and receive levels may be adjusted if necessary using jumpers at the positions ST1 and ST2.

Attention! Any transmit level changes are not permitted within the network of the German Telekom!

Sendepiegel

Position ST2	Pegel	
	Wähltg. (an Z)	Standtg. (an 600 Ω)
	-4,5 dBm	-6 dBm
	-6,5 dBm	-8 dBm
	-8,5 dBm	-10 dBm
	-10,5 dBm *	-12 dBm

* Auslieferungszustand

Position ST1	Empfangs- pegel- bereich (an Z)
	-43 dBm *
	-33 dBm

* Auslieferungszustand

2.6 Board of the LOGEM® 928 (Standalone Version)

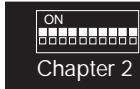
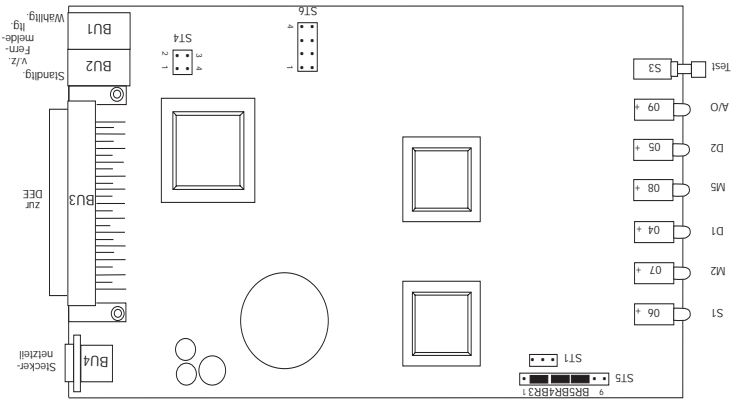

The switches ST1 and ST2 are accessible from the bottom of the devices. If changes at the jumpers are necessary the modem has to be opened at the marked spots using a screwdriver.

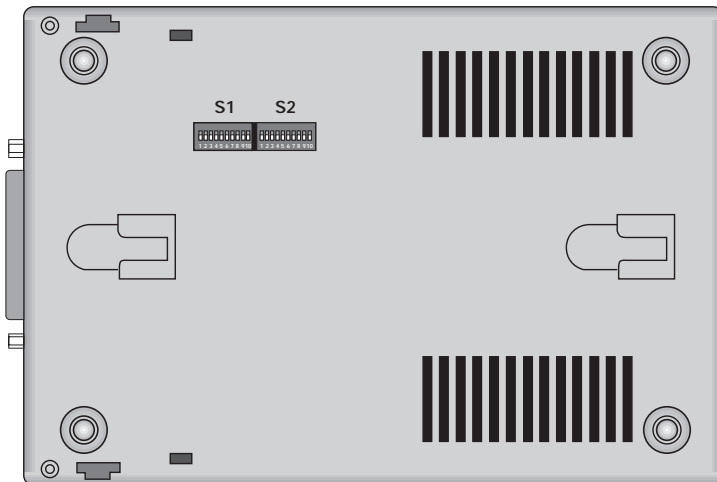





2.7 Transmit and Receive level (Rackmounted Version)



Transmit and receive levels may be adjusted if necessary using jumpers at the positions ST1 and ST2.

Attention! Any transmit level changes are not permitted within the network of the German Telekom!

transmit levels

position ST2	level	
	dial line (at Z)	leased line (at 600 Ω)
	-4,5 dBm	-6 dBm
	-6,5 dBm	-8 dBm
	-8,5 dBm	-10 dBm
	-10,5 dBm *	-12 dBm

* delivery state

position ST1	receive level (at Z)
	-43 dBm *
	-33 dBm

* delivery state

2.8 Board of the LGM 28.8D1

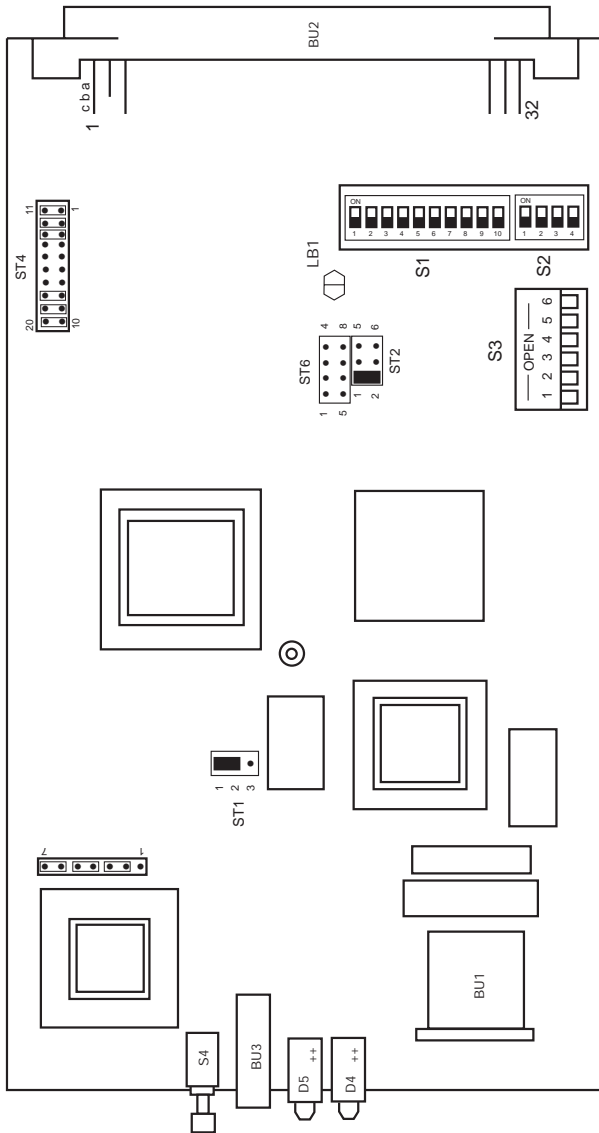

2.9 Transmit And Receive Level (Top Rail Version)

Transmit and receive levels may be adjusted if necessary using jumpers at the positions ST1 and ST2.

Attention! Any transmit level changes are not permitted within the network of the German Telekom!



transmit levels

basic board ST4	levels		
	Germany (at Z)	Austria (at 600 Ω)	Switzerland (at 600 Ω)
	-4,5 dBm	-9 dBm	-9 dBm
	-6,5 dBm	-9 dBm	-9 dBm
	-8,5 dBm	-11 dBm	-11 dBm
	-10,5 dBm*	-13 dBm	-13 dBm

*delivery state: transmit level -10,5 dBm

receive levels

control board ST4	receive level
	-43 dBm**
	-33 dBm

** delivery state: receive level -43 dBm dBm

2.10 Board of the LGH 28.8D1

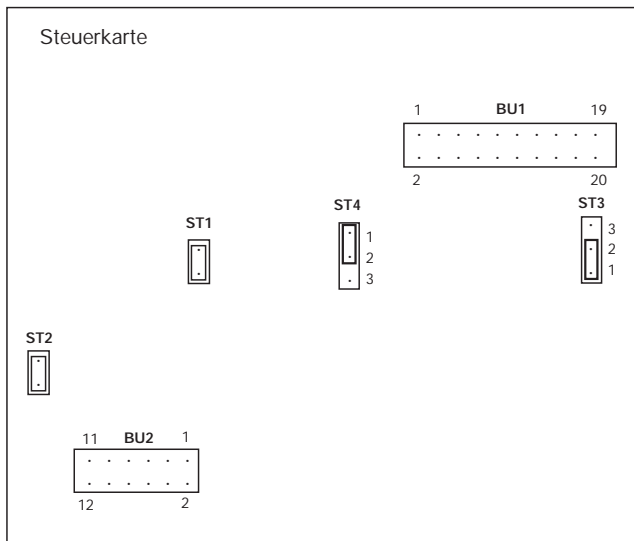
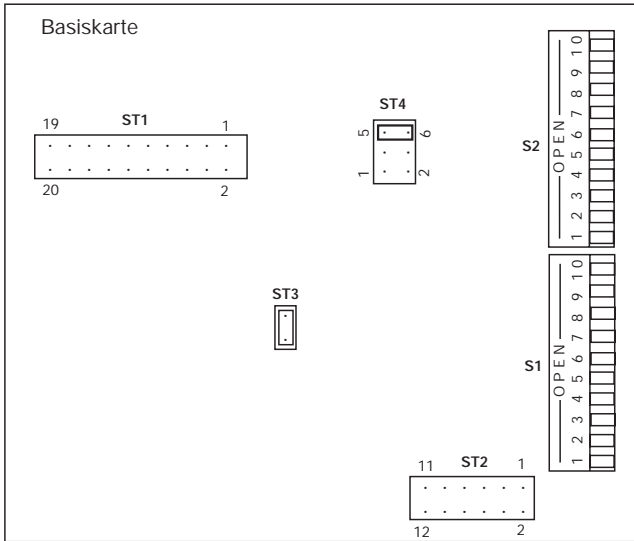

2.11 Country Setting for LGH 28.8D1

Due to different network accesses the LGH 28.8D1 may be set to country specific adjustments using jumpers. In delivery state the jumpers are set for operation in the network of the Federal Republic of Germany.

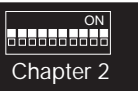

	basic board	control board		
Country	ST3	ST1	ST2	ST3
Germany	●	●	●	1-2
Austria	○	○	●	2-3
Switzerland	○	●	○	1-2

Legend:

- jumper installed
- no jumper installed

Attention! After changing over from country setting the command AT&W2 has to be typed after start up to reload the country specific parameters to the registers.

3	AT Commands	67
3.1	General	67
3.2	Command Description	68
3.3	Telephone and Dialing Features	69
3.3.1	Test Loops	77
3.3.2	Storing and Displaying of Telephone Numbers	78
3.4	Report Codes	79
3.5	Changing of Register Contents	83
3.6	Activation of Control and Report Lines	86
3.7	Data Protection Protocols	89
3.7	BREAK Handling	92
3.8	Handshake	93
3.9	Module Functions	95
3.10	Password Protection	96
3.11	Remote Configuration	100
3.12	Loudspeaker	101





3 AT Commands

3.1 General

The AT command set is an international standard developed by the US modem manufacturer Hayes (Hayes standard). All commands (AT commands) of the Hayes standard begin with an AT (ATTENTION).

The AT command set is used only for asynchronous serial mode operation. You must run a terminal software on your computer to send AT modem commands.

Please refer to the following conventions when working with AT commands:

- the default data format is 1 start bit, 8 data bits, no parity, 1 stop bit (10 bit/character)
- the automatic baud rate detection operates up to 57600 bps
- a command line begins always with an AT or at
- a command line may include several commands
- a command line is terminated with a carriage return character (CR, ASCII 13, RET, Return)
- the modem gives an **OK** after valid commands, an **ERROR** is issued for invalid commands

Generally most data transmission software products feature a communication module that is compatible to the Hayes standard.

Please refer to the rules listed below when typing AT commands:

n stands for a decimal number

x is a text block

The command interpreter sets automatically a "0" whenever you do not type the necessary decimal number for an AT command.



3.2 Command Description

A/ Repeat Last Command Line

The modem repeats the last command line that was typed. The command A/ is not terminated with a carriage return (CR).

The command is very useful whenever a call was not successful as the subscriber was occupied. With the A/ command you can restart the command line without typing it again.

ATE(n) Echo ON/OFF

The command ATE(n) defines if the modems transfer characters to the DTE as an echo or if they do not send any characters during command mode. If you type the command ATE(n) without a parameter the modems set automatically the value 0. Any received characters are not returned to the DTE as an echo.

command	parameter/default	description
ATE(n)	0, 1 / 1	character echo
	n = 0	echo OFF
	n = 1	echo ON

AT(Befehl)? Help Feature for AT Commands

With the command AT(Befehl)? [AT(Command)?] you can display the current modem setting, a short description and the valid range of parameters for the command.

Example:

```

AT\N?
1    ECC mode (0..5)
OK
    
```

AT&B Deactivate Command Phase

The command interpreter is deactivated with the command AT&B. After typing the command any characters coming from the DTE are being ignored as long as the modems have not established a connection. During the connect phase the escape sequence (+++) is not being evaluated, remote configuration is not possible. This command should only be used for leased line applications. After saving with AT&B&W activation of the command phase is only possible by loading a default setting.

3.3 Telephone and Dialing Features

+++ Escape Sequence

The escape sequence consists of three characters defined in register S2 (default setting: = 2B (hex) = 43 (dec)) and is designed for switching from transparent to command mode. The timeout before and after typing of the escape sequence is defined in register S12.

Successful switching to command mode is indicated with an OK report. At error protected connections this process may last max. 2 seconds. You may use any other code for the escape sequence that can be specified in register S12.

The modems do not terminate any existing dialing connection. Operating parameters may only be changed during command mode, you have to switch back then to transparent mode using the command AT0.

An existing connection may be terminated with the command ATH.

In direct mode a connection can be terminated by switching the the line S1 (DTR). The S1 option (AT&D(n)) direct mode applications should be set to the values 2 or 3.

ATA Answer

The ATA command is designed for manual acceptance of an incoming call. The automatic call acceptance is deactivated if register S20 (count of rings) is set to 0. You can accept an incoming call by:

- lifting the receiver and typing the command ATA after recognizing the dial tone
- or typing the command ATA at an incoming call (ringing).

As an alternative a call can be accepted with the command ATS0=1 (activated automatic call acceptance).

ATD/Kurzname Dial Up with Short Name

The modem dials the dial character sequence xxx that is registered in the number storage.

Example: AT&Z5=0511 xxx / ke-e (CR)
ATD/ke-e (CR)

The modem dials the telephone number 0511 xxx.



ATD xxx Dialing Command

The command ATD is utilized to transfer a dialing command to the modems. The dial character sequence xxx is dialed automatically. The line editor accepts the parameters listed below as dialing modifiers:

parameter	description
0 ... 9	dial digits
: and W	wait for dial tone
>	ground key activation for 255 ms
L	repeat last dial
U	deactivate V.8 dialing sequence for dial up
S=(n)	dial short dial number
& and !	flash pulse
P	pulse dialing
T	tone dialing
*,#,A,B,C,D	special characters for tone dialing
;	modem stays in command mode after dialing (necessary for Windows applications)
-	group separation character
SPACE	group separation character
/LABEL/	dial up with label
(and)	group separation characters
,	dial pause (ref. to register S8)

Example for automatic dialing with the ATD command:

Subscriber at a PABX with tone dialing procedure:

command sequence: ATDT 0 W0511 , 6747390 CR

ATD	dial up command
T	tone dialing
0	central office access (important for PABX)
W	wait for dial tone recognition
0511	area code Hanover
,	dial pause
67...	subscriber number
CR	carriage return (end of dialing sequence)

Dial Abortion:

The dialing process is being aborted if the modem is not able to establish a connection within 100 secs (ref. to register S7). You can initiate an early dial abortion by typing any character (ref. to register S20).

ATDS=(n) Dial Up with Number Storage

The modem dials the dial sequence (XXX) that was saved in the number storage **n** (ref. to command AT&Z).

Example: AT&Z1= 0511 67 47 390/KE-E (CR)
 ATDS = 1 or ATD/KE-E (CR)

The modem dials the stored number automatically. The "/" (slash) is only necessary if further commands are being typed.



ATF(n) Transmission Procedure

The command ATF(n) is utilized to set the transmission procedure of the modems on the telephone line. The table printed below can be requested with the command ATF??.

command	description	valid switches table for ATSET(n)=x command
ATF 0	as ATF255	
ATF 1	V.21 (300/300 bit/s, dx)	LGM 1200H1
ATF 2	V.22 (1200/1200 bit/s, dx)	LGM 2400D2
ATF 3	V.22bis (2400/2400 bit/s, dx)	
ATF 4	V.23 (fixed 75/1200 bit/s, dx)	LGM 1200H1
ATF 5	V.23 (fixed 1200/75 bit/s, dx)	
ATF 20	V.32	
ATF 21	V.32 (fixed 4800 bit/s, dx)	
ATF 22	V.32 (fixed 7200 bit/s, dx)	
ATF 23	V.32 (fixed 9600 bit/s, dx)	
ATF 25	V.32bis	
ATF 26	V.32bis (fixed 12000 bit/s, dx)	
ATF 27	V.32bis (fixed 14400 bit/s, dx)	
ATF 30	V.Fast-Class (V.FC)	
ATF 31	V.FC (fixed 14400 bit/s, dx)	
ATF 32	V.FC (fixed 16800 bit/s, dx)	
ATF 33	V.FC (fixed 19200 bit/s, dx)	
ATF 34	V.FC (fixed 21600 bit/s, dx)	
ATF 35	V.FC (fixed 24000 bit/s, dx)	
ATF 36	V.FC (fixed 26400 bit/s, dx)	
ATF 37	V.FC (fixed 28800 bit/s, dx)	
ATF 40	V.34	
ATF 41	V.34 (fixed 2400 bit/s)	
ATF 42	V.34 (fixed 4800 bit/s)	
ATF 43	V.34 (fixed 7200 bit/s)	
ATF 44	V.34 (fixed 9600 bit/s)	
ATF 45	V.34 (fixed 12000 bit/s)	
ATF 46	V.34 (fixed 14400 bit/s)	
ATF 47	V.34 (fixed 16800 bit/s)	
ATF 48	V.34 (fixed 19200 bit/s)	
ATF 49	V.34 (fixed 21600 bit/s)	
ATF 50	V.34 (fixed 24000 bit/s)	
ATF 51	V.34 (fixed 26400 bit/s)	
ATF 52	V.34 (fixed 28800 bit/s)	
ATF 253	autom. detection of modulation procedure incl. V.32bis	
ATF 254	autom. detection of modulation procedure (highspeed, starting with V.32)	
ATF 255	autom. detection of modulation procedure (all modulation procedures) default setting	

ATH Disconnect

An existing data connection is terminated (on hook function).

ATI(n) Identification

This command is employed to check for perfect connection between DTE and modem.

command	parameter/default	description
ATI(n)	0...2	modem identification
	0	software version
	1	V.42bis/MNP software version
	2	modem revision level

ATO Switching to Transparent Mode

During an existing connection the modems switch back from command to transparent mode after typing the command ATO.

You can change between the two modes using the escape sequence (e.g. +++) and the ATO command.

If a connection is not yet established the modems do not occupy the telephone line and report an ERROR code.

Please make sure to type the letter **O** and not the number **0** in this case.

Example:

- established data connection
- modem operates in transparent mode

input	+++	escape sequence
report	OK	input acknowledgement and change to command mode
input	ATS46=100 (CR)	changing of register S46
report	OK	input acknowledgement
input	ATO (CR)	reswitching to transparent mode
report	CONNECT 2400	data connection with 2400 bit/s is established again, modem operates in transparent mode

ATP Pulse Dialing

For dial up in public networks the modems must be set to pulse dialing normally. After typing the command ATP all dialing attempts are performed using pulse dialing procedures.

ATT Tone Dialing

For dial up at PABX systems and digital exchanges operating with multi-frequency dialing the modems must be set to tone dialing. After typing the command ATT all dialing attempts are performed using tone dialing procedures.

ATU(n) Ringing Tone

In delivery state the modems feature an V.8 ringing sequence (V.21) acc. to ITU-T. As this sequence might cause problems with some fax switches during establishment of a connection the V.8 ringing tone can be deactivated.

command	parameter/default	description
ATU(n)	0, 1 / 0	V.8 ringing tone
	0	active V.8 sequence
	1	inactive V.8 sequence

AT&G(n) Guard Tone

At international connections line occupation might be controlled by the exchange implementing a 550 or 1800 Hz guard tone to prevent accidental disconnection. Guard tones are not used for calls inside the U.S..

command	parameter/default	description
AT&G(n)	0...2/ 0	guard tone
	0	no guard tone
	1	550 Hz guard tone
	2	1800 Hz guard tone

AT&L(n) Line Selection

The command is utilized for modem configuration for switched and leased line operation.

command	parameter/default	description
AT&L(n)	0...15 / 0	line selection
	0	dial line
	1	2 wire leased line (initiate with ATA or ATD)
	2	2 wire leased line, originator (master)
	3	2 wire leased line, answerer (slave)
	4*	4 wire leased line, originator (master)
	5*	4 wire leased line, answerer (slave)
	6*	2 wire leased line with dial backup, originator (master)
	7*	2 wire leased line with dial backup, answerer (slave)
	8*	4 wire leased line with dial backup, originator (master)
	9*	4 wire leased line with dial backup, answerer (slave)
	10*	2 wire leased line via DBU board**, originator (master)
	11*	2 wire leased line via DBU board**, answerer (slave)
	12*	2 wire leased line with 2 wire leased line backup**, originator (master)
	13*	2 wire leased line with 2 wire leased line backup**, answerer (slave)
	14*	2 wire leased line with 2 wire leased line backup**, originator (master)
	15*	2 wire leased line with 2 wire leased line backup**, answerer (slave)

* The dial backup board (DBU) has to be installed.

** The switched line interface is utilized for the backup line which is configured automatically for leased line application in this operation mode.



Attention! The top rail version LGH 28.8D1 is not applicable for any of the dial backup applications described here.

AT&M(n) Selection of Transparent Operation Mode

command	parameter/default	description
AT&M(n)	0, 1 / 0	asyn./syn. mode
	0	asynchronous operation
	1	asynchronous command mode, synchronous transparent mode

AT%D(n) Temporarily Blocked Numbers

The modems can block telephone numbers temporarily for any dial attempts (command ATD xxx). A list of these numbers can be displayed with the command AT%D.

Temporarily Blocked Numbers:

Sometimes it occurs that a data connection cannot be established after the first dial attempt. In those cases several dial attempts might be necessary. The timeout between the dial attempts for the same telephone number must be at least 5 secs. between the 1st and 2nd and the 2nd and 3rd dial attempt. For any further dial attempt the timeout is 60 secs.. The modems give an DELAYED CALL report for any dial attempt that is made within the timeout period.

Blocked Automatic Dialing:

After 12 unsuccessful dial attempts (with arbitrary telephone numbers) the modem is blocked completely and sends a BLACKLISTED report. The BLACKLISTED state is cancelled after approx. 2 hours or whenever you deactivate your modem and switch it on again. If this dialing procedure causes any problems with your DTE the mode can be changed by setting register S81.

3.3.1 Test Loops

AT&T(n) Test Loops

The command AT&T comes with different independent groups of settings. The settings for the different groups have to be typed consecutively. The commands AT&T0 and AT&T1 are processed immediately. With the command AT&T? you can display the current setting and other possible adjustments. At an active loop the LED A/O, ANS or LB flash up constantly.

command	parameter/default	description
AT&T(n)	0,1, 4...6, 17...20 / 6, 17, 20	test loops
	0	terminate local loop initiated with AT&T1
	1	initiate local loop
	4	accept local loop (PS2)
	5	reject local loop (PS2)
	6	accept local loop (PS2), the loop is terminated automatically after 5 mins.
	17	accept local loop and local request for remote loop
	18	ignore local loop and local request for remote loop
	19	local loop breaks existing connection and initiates local loop
	20	local loop is only accepted if no connection is established



3.3.2 Storing and Displaying of Telephone Numbers

AT&Z(n)? Display Telephone Number

Displays the number stored with the command AT&Z(n).

AT&Z? Display All Telephone Numbers

Displays all stored telephone numbers.

AT&Z(n)=(x) Store Telephone Number

With the command AT&Z you can store max. 20 numbers (n = 0...19).

Example: AT&Z1 = 0511\67 47 390/KE-E (CR)

The parameters listed below are applicable with the ATD command:

parameter	description
no parameter	data button function "call"
P	pulse dialing
T	tone dialing
0 ... 9	dial digits
*	special function, only for tone dialing
U	disable V.8 calling sequency for dial up
#	special function, only for tone dialing
>	ground key activation for 255 ms
& and !	flash pulse, only for tone dialing
/Label	short dial with label
,	dial pause
-	group separation character, not to be evaluated
SPACE	group separation character, not to be evaluated
()	group separation character, not to be evaluated
\	group separation character, not to be evaluated

3.4 Report Codes

Report codes are informations that the modems transfer to the DTE e.g. invalid commands are acknowledged with an ERROR report.

ATQ(n) Result Codes ON/OFF

Display of report codes can be selected using the ATQ command.

command	parameter/default	description
ATQ(n)	0, 1 / 0	result codes
	0	display result codes
	1	no result codes

ATV(n) Verbose Result Codes

Using the command ATV you can display result codes in numerical or text form.

command	parameter/default	description
ATV(n)	0, 1 / 1	verbose result codes
	0	numerical result codes
	1	text result codes

ATX(n) Result Codes Normal/Extended

The modems can issue up to 70 different result codes. The command ATX(n) is utilized to select an individual display of result codes necessary for your application.

command	parameter/default	description
ATX(n)	0...4 / 4	result codes normal/extended
	0	report codes 0 - 4
	1	report codes 0-38 and 90-104
	2	report codes 0-65 and 123,124
	3	report codes 0-144
	4	report codes numerical 0-144, for text reports with protocol information, i.e. CONNECT2400/COMP/V.42bis



AT&I(n) CONNECT Reports

The modems issue a CONNECT report after successful dialup. As an addition the transmission rate can be displayed with extended result codes. With the command AT&I(n) you can select the transmission rate to be displayed.

command	parameter/default	description
AT&I(n)	0, 1 / 0	CONNECT reports
	0	report modem transmission rate
	1	report DTE transmission rate



Report Codes Table:

report code	text	description
0	OK	correct input
1	CONNECT	data connection
2	RING	incoming call
3	NO CARRIER	no/weak receive signal
4	ERROR	wrong input
5	CONNECT 1200	data connection 1200 bit/s
6	NO DIALTONE	no dial tone
7	BUSY	busy tone received
8	NO ANSWER	no answer tone received
10	CONNECT 2400	data connection 2400 bit/s
15	ABORT	no loop current
26	BLACKLISTED	autom. dialing blocked
27	DELAYED CALL	autom. dialing delayed
30	CONNECT 9600	data connection 9600 bit/s
31	CONNECT 4800	data connection 4800 bit/s
32	CONNECT 7200	data connection 7200 bit/s
33	CONNECT 12000	data connection 12000 bit/s
34	CONNECT 14400	data connection 14400 bit/s
35	CONNECT 16800	data connection 16800 bit/s
36	CONNECT 19200	data connection 19200 bit/s
37	CONNECT 75/1200	data connection 75/1200 bit/s
38	CONNECT 1200/75	data connection 1200/75 bit/s
40	CONNECT 1200/HDX	HX data connection 1200 bit/s
50	CONNECT 300/REL	data connection 300 bit/s
51	CONNECT 1200/REL	data connection 1200 bit/s
52	CONNECT 2400/REL	data connection 2400 bit/s
53	CONNECT 9600/REL	data connection 9600 bit/s
54	CONNECT 4800/REL	data connection 4800 bit/s
55	CONNECT 7200/REL	data connection 7200 bit/s
56	CONNECT 12000/REL	data connection 12000 bit/s
57	CONNECT 14400/REL	data connection 14400 bit/s
58	CONNECT 16800/REL	data connection 16800 bit/s
59	CONNECT 19200/REL	data connection 19200 bit/s
60	CONNECT 38400/REL	data connection 38400 bit/s
61	CONNECT 57600/REL	data connection 57600 bit/s
62	CONNECT 21600/REL	data connection 21600 bit/s
63	CONNECT 24000/REL	data connection 24000 bit/s
64	CONNECT 26400/REL	data connection 26400 bit/s
65	CONNECT 28800/REL	data connection 28800 bit/s
66	CONNECT 31200/REL	data connection 31200 bit/s
67	CONNECT 33600/REL	data connection 33600 bit/s



report code	text	description
70	CONNECT 300/COMP	data connection 300 bit/s
71	CONNECT 1200/COMP	data connection 1200 bit/s
72	CONNECT 2400/COMP	data connection 2400 bit/s
73	CONNECT 9600/COMP	data connection 9600 bit/s
74	CONNECT 4800/COMP	data connection 4800 bit/s
75	CONNECT 7200/COMP	data connection 7200 bit/s
76	CONNECT 12000/COMP	data connection 12000 bit/s
77	CONNECT 14400/COMP	data connection 14400 bit/s
78	CONNECT 16800/COMP	data connection 16800 bit/s
79	CONNECT 19200/COMP	data connection 19200 bit/s
80	CONNECT 38400/COMP	data connection 38400 bit/s
81	CONNECT 57600/COMP	data connection 57600 bit/s
82	CONNECT 21600/COMP	data connection 21600 bit/s
83	CONNECT 24000/COMP	data connection 24000 bit/s
84	CONNECT 26400/COMP	data connection 26400 bit/s
85	CONNECT 28800/COMP	data connection 28800 bit/s
86	CONNECT 31200/COMP	data connection 31200 bit/s
87	CONNECT 33600/COMP	data connection 33600 bit/s
90	CONNECT 21600	data connection 21600 bit/s
91	CONNECT 24000	data connection 24000 bit/s
92	CONNECT 26400	data connection 26400 bit/s
93	CONNECT 28800	data connection 28800 bit/s
94	CONNECT 38400	data connection 38400 bit/s
95	CONNECT 57600	data connection 57600 bit/s
96	CONNECT 31200	data connection 31200 bit/s
97	CONNECT 33600	data connection 33600 bit/s
103	CONNECT 76800	data connection 76800 bit/s
104	CONNECT 115200	data connection 115200 bit/s
123	CONNECT 76800/REL	data connection 76800 bit/s
124	CONNECT 115200/REL	data connection 115200 bit/s
143	CONNECT 76800/COMP	data connection 76800 bit/s
144	CONNECT 115200/COMP	data connection 115200 bit/s

/REL indicates an error protected connection.

/COMP indicates a connection with data compression (MNP5 or V.42bis).

3.5 Changing of Register Contents

ATS(n) = (x) Set Registers

The modem registers listed below may be changed:

reg.	description	values	default
S0	count of rings	0-5	1
S2	ESCAPE character	0-255	43 (+)
S3	carriage return (CR)	0-255	13
S4	line feed (LF)	0-255	10
S5	backspace	0-255	8
S7	connect timeout	10-100	100 = 100s
S8	dial pause	1-30	2 = 2s
S10	carrier timeout	2-100	50 = 5s
S12	break sequence guard time	1-255	45 = 900 ms
S20	dial abort character	0-255	255
S26	S2-M2 delay time	0-255	4 = 40 ms
S37	inactivity timeout	0-255	0
S39	XON character	0-255	17 (CTRL-Q)
S40	XOFF character	0-255	19 (CTRL-S)
S50	transmission procedure	0-5, 20-23, 25-27, 30-37 40-52, 253- 255	255
S51	DTE interface rate	2-15, 20,255	255
S52	DTE baud rate	1-255	48(38400bps)
S54	function test button	0-5	1
S60	online phase data format	0-11	0
S61	command phase data format	0-11	0
S63	dial backup reswitching	6-255	6 = 60 s
S64	DBU swiching procedure	0-1	1
S65	DBU reswitching/hour	1-255	4
S66	DBU reswitching/day	1-255	16
S67	M3 function at DBU	0-1	1
S80	command interpreter	0-3	0
S81	dialing mode	0-1	0
S90	max. transm. rate fax operation	0-5	5
S91	ECM mode fax operation	0-1	1
S100	echo character (password mode)	0-255	42 (*)
S102	M3 function at password	0-1 0	



The modems store the register contents in the RAM. These register settings are not available after modem deactivation. For further utilization of these register settings they must be stored in the modems (nonvolatile) EEPROM using the command AT&W(n)! The settings can be activated later with the ATZ(n) command or by deactivating and restarting the modem.

ATS? Register Display

With the ATS? command you can display all current register settings.

AT&W(n)? Read Register (n)

The modems read and display the register content of the register (n). Please refer to the chapter "Register Description" for a complete listing of all valid modem registers.

ATZ(n) Load User Setting (n)

The modems initiate a reset and then recall one of the user settings specified with n = 0...2 from the EEPROM.

AT&F(n) Load Basic Setting

The AT&F command restores the factory default register settings that are stored in the ROM. Only basic setting 8 may be overwritten and corresponds to user setting 2.

After typing AT&F(n) the modems transfer these values to the RAM for further processing.

AT&W(n) Save User Setting

The AT&W(n) command stores user defined settings in the modem's nonvolatile memory (EEPROM). You can save individual profiles generated with the ATS command for further utilization.

command	parameter/default	description
AT&W	0...2 / 2	save user setting
	0	save user setting 0
	1	save user setting 1
	2	save as basic setting 8

AT&Y(n) Load User Setting

With the AT&A(n) command you select the user setting to load from the EEPROM after POWER ON.

command	parameter/default	description
AT&Y(n)	0...2 / 2	load user setting
	0	load user setting 0
	1	load user setting 1
	2	load user setting 2 (identical to basic setting 8)

AT&V(n) Display Settings

The command AT&V displays all RAM and EEPROM configurations an " * " indicates the configuration that will be loaded after modem startup.

command	parameter/default	description
AT&V(n)	0...4 / 4	display settings
	0	display active configuration
	1	display RAM and EEPROM configuration
	2	display basic settings 0...2
	3	display basic settings 3...5
	4	display basic setting 6, 7 and user setting

Example:

AT&V0

Version 4.04 D

Option: Keine

```
F255 E1 L1 M1 Q0 X4 V1 P \Q2 \G0 \A1 \C3 \L0 \N3 \X1 \K3 \B3 %C1
%E1 %M0 %R0 &L0 &Y0 &I0 &X0 &G0 &M0 &C2 &D2 &H0 &R1 &S1 &T5
S00=001 S01=000 S02=043 S03=013 S04=010 S05=008 S07=100
S08=002 S10=050 S12=045 S20=255 S26=004 S28=000 S37=000
S39=017 S40=019 S45=000 S50=255 S51=255 S54=001 S60=000
S61=000 S62=030 S63=006 S64=001 S65=004 S66=016 S67=000
S80=000 S81=000 S90=005 S91=001 S100=042 S101=000 S102=000
OK
```

AT\S Display Parameters

The command AT\S displays the current modem settings.

Example:

```

AT\S
Konfiguration:
F Betriebsart ..... Auto      \X XON/XOFF-Weitergabe . 1   &T Teststellungen ..... 5
L Lautstärke ..... 1         %C Kompressions-Mode ..... 1   &X Taktvariante ..... 0
M Lautsprecher ..... 1       %E Retrain ..... 1         &Y Start-Profil ..... 0
Q Meldungen ..... 0         %M Passwort-Modus ..... 0   Autobaud ..... 1
V Text/Numerisch ..... 1     %R Rate-Change ..... 0     DEE-Baudrate ..... 19200
X Meldungsart ..... 4       &C M5-Option ..... 2       Fernkonfig ..... 0
\A MNP-Blocklaenge ..... 1   &D S1-Option ..... 2       AT/V.25bis-Befehle ..... 0
\c MNP-Handshake ..... 3     &H Simuliert Hx ..... 0     Testtaste ..... Datentaste
\G Modem-Flusskontrolle .. 0   &I Connect-Meldung ..... 0   Rufannahme ..... 1
\K Break-Handling ..... 3    &L Standleitung ..... 0     Fax-Speed ..... 5
\L Block/Stream-Mode ..... 0  &M SyncBetrieb ..... 0     Fax-ECM ..... 1
\N ECC-Modus ..... 3        &R M2-Option ..... 1       Fax-Class ..... 0
\Q DEE-Flusskontrolle ..... 2  &S M1-Option ..... 1
OK
    
```

3.6 Activation of Control and Report Lines

AT&C(n) M5 Option

The modems activate the interface line M5/109 according to the parameters set with the command AT&C.

command	parameter/default	description
AT&C(n)	0..2 / 2	M5 option
	0	M5/109 is always active
	1	M5/109 follows receive signal level
	2	M5/109 is ON during transparent mode and OFF during command mode

AT&D(n) S1 Option

The command controls the operation of the interface line S1/108 (DTR).

command	parameter/default	description
AT&D(n)	0...6 / 2	S1 option
	0	S1/108 is ignored by the modems
	1	commands are received at inactive S1/108. Incoming calls are not accepted. An ON/OFF change terminates the existing connection.
	2*	an ON/OFF change at S1/108 terminates the connection. auto answer mode and line switching are not possible in OFF state.
	3*	an ON/OFF change at S1/108 causes a reset (command ATZ)
	4**	the modem dials the calling number from the dialling register Z0 at an ON/OFF change at S1/108
	5*	as AT&D3; an ON/OFF change at S1/DTR causes a hardware reset
	6*	as AT&D1; an incoming call is accepted at inactive S1/DTR

* AT commands are not accepted at inactive S1/DTR line.

** Only outgoing dial up is possible.



AT&R(n) M2 Option

The command controls the interface line M2/106 if synchronous operation was selected with AT&M1.

command	parameter/default	description
AT&R(n)	0...2 / 1	M2 option
	0	the interface line M2/106 follows S2/105 with a delay to be specified in register S26
	1	M2/106 is constantly ON
	2	M2 is only active during data transmission phase

AT&S(n) M1 Option

The commands controls the interface line M1/107.

command	parameter/default	description
AT&S(n)	0...2 / 1	M1 option
	0	M1/107 is constantly active
	1	M1/107 is ON during data transmission
	2	M1/107 is set to ON before the CONNECT report

AT&X(n) Synchronous Clock

During synchronous operation (AT&M1) the transmit clock can be set according to the parameters selected.

command	parameter/default	description
AT&X(n)	0...2 / 0	synchronous clock
	0	internal clock T2/114
	1	external clock T1/113
	2	transmit clock = receive clock T4/115

3.7 Data Protection Protocols

AT\A(n) MNP Block Length

The max. number of characters can be set when implementing the Microcom Networking Protocol (MNP).

Due to compatibility reasons the parameters 2 and 3 are acknowledged with an OK. Internally the parameters are set to "1" generally.

command	parameter/default	description
AT\A(n)	0...3 / 1	MNP block length
	0	max. 64 characters/block
	1	max. 256 characters/block
	2	max. 256 characters/block
	3	max. 256 characters/block

AT\C(n) Automatical MNP Detection

During auto reliable mode (AT\N3) the modems try to establish a data protection protocol (V.42/MNP4) for each data connection. This feature can be cancelled using the command AZ\N(n), i.e. the modems operate in normal mode.

command	parameter/default	description
AT\C(n)	0...3 / 3	automatical MNP detection
	0	function deactivated
	1	function active, no data buffering
	2	idle
	3	function active, with 200 characters data buffering

AT\L(n) MNP Block/Stream Mode

command	parameter/default	description
AT\L(n)	0,1 / 1	MNP block/stream mode
	0	stream link mode, each character is transmitted immediately. At a large number of consecutive characters the frame length follows the AT\A parameter.
	1	block mode, the modems transform only complete blocks received from the DTE (the block length is 249 data bytes and 7 bytes frame information)

AT\N(n) Error Correction Procedure

command	parameter/default	description
AT\N(n)	0...5 / 3	error correction procedure
	0	normal mode, no error correction, V.42 or MNP4 deactivated, data compression with V.42bis or MNP5 is not possible
	1	direct mode*, V.24 interface rate corresponds to modem transmission rate, no error correction, V.42 or MNP4 deactivated, data compression with V.42bis or MNP5 is not possible
	2	reliable mode a connection is terminated if the remote modems is not in reliable mode. no error correction, V.42 or MNP4 activated, data compression with V.42bis or MNP5 is possible
	3	auto reliable mode the modem switches to normal mode if the remote modem is not in reliable mode, no error correction, V.42 or MNP4 activated, data compression with V.42bis or MNP5 is possible
	4	reliable mode the modems expect a fault protected connection acc. to ITU-T V.42 (data compression acc. to V.42bis is possible)
	5	reliable mode the modems expect a fault protected connection with MNP4 (data compression acc. to MNP5 is possible)

* For direct mode the AT&D(n) option has to be set for connection deestablishment with S1 ON/OFF as the „+++“ escape sequence is not valid during direct mode.

AT\O Initiate MNP

The modems initiate reliable mode from normal mode. Then the modems send two reliable link sequences. If the modem does not respond after 20 secs. the data connection remains as it was before. If the remote modem accepts the request the current connection is displayed with a CONNECTxxx report.

This command is only applicable during in command mode after the ESCAPE sequence. It refers to the subsequent establishment of a MNP connection using the AT\U command.

AT\Y Initiate MNP Error Correction

The command is utilized to request an MNP connection from command mode which is normally not valid for MNP operation. First transmit a ESCAPE sequence (+++) and then the command AT\Y. The modem operating in originate mode now begins to initiate an error protected connection (reliable link) to the remote modem. The remote modem which is in answer mode waits max. 9 secs. for the establishment of a reliable link (supposed AT\C1 or AT\C3 is selected). If the establishment of a reliable link is not possible after the second attempt the modems remains in a non MNP connection.

AT\Z Deactivate MNP Error Correction

The modems switch during the ESCAPE state of an MNP connection from reliable to normal mode.

The contents of the buffer is being erased.

AT%A(n) Autoreliable Fallback Character

The autoreliable fallback character may be set here by typing a value for the parameter "n".

This command is only processed during auto reliable mode with activated AT\C1 or AT\C3 commands.

command	parameter/default	description
AT%A(n)	0...127 / 0	autoreliable fallback character



AT%C(n) Select Data Compression

Select an error protocol with or without data compression.

command	parameter/default	description
AT%C(n)	0...3 / 1	select data compression
	0	no data compression
	1	data compression active (V.42bis or MNP5)
	2	V.42bis for transmit data only
	3	V.42bis for receive data only

**3.7 BREAK Handling****AT\B(n) BREAK Signal Length**

The modems can send a BREAK signal to the remote modem. The BREAK signal length is defined by the command AT\B. The BREAK signal is transferred during reliable mode as well. Whenever the modem receives an arbitrary BREAK signal from the remote modem it is transferred only in direct mode with an identical length to the interface.

command	parameter/default	description
AT\B(n)	1...9 / 3	BREAK signal length
	1	100 ms
	2	200 ms
	3	300 ms
	4	400 ms
	5	500 ms
	6	600 ms
	7	700 ms
	8	800 ms
	9	900 ms

AT\K(n) BREAK Handling

The command controls the BREAK signal handling and is not applicable during direct mode.

command	parameter/default	description
AT\K(n)	0...3 / 3	BREAK handling
	0	ignore BREAK
	1	erase data buffer, transfer BREAK
	2	transfer BREAK immediately
	3	transfer BREAK with transmit/ receive data

3.8 Handshake**AT\G(n) Data Flow Control**

The command controls the data flow between local and remote modem.

command	parameter/default	description
AT\G(n)	0, 1 / 0	data flow control
	0	no data flow control
	1	XON/XOFF data flow control, the modems are no longer transparent if AT\G1 is selected

AT\Q(n) Select Flow Control

The command defines the flow control procedure to be utilized between DTE and modem. Flow control is not applicable for direct mode operation. Data flow control is employed whenever DTE and line rate have any differences or when the data flow has to be stopped for block retransmissions during error controlled mode. You can either employ hardware flow control (RTS/CTS) or software flow control (XON/XOFF).

command	parameter/default	description
AT\Q(n)	0...3 / 2	select flow control
	0	no flow control
	1	XON/XOFF flow controll
	2	RTS/CTS flow control with S2/105 and M2/106
	3	flow control with XON/XOFF and S2/M2

AT\X(n) XON/XOFF Transfer

The AT\X command controls the transfer of XON/XOFF characters in connection with the commands AT\G and AT\Q. If the command AT\G1 is active the devices perform modem to modem flow control.

command	parameter/default	description
AT\X(n)	0, 1 / 0	XON/XOFF transfer
	0	no XON/XOFF transfer
	1	XON/XOFF transfer

AT%E(n) Retrain

The command defines if the modems initiate automatic retrains. Any requested retrains are acknowledged.

command	parameter/default	description
AT%E(n)	0, 1 / 1	retrain
	0	no automatic retrains
	1	automatic retrains on request

AT%R(n) Rate Change

The command allows for control of transmission rate adaptation during the transmission procedure. The rate adaptation is performed with regard of lower or higher transmission rates. Rate change is not applicable for direct mode and synchronous T1/T4 operation.

command	parameter/default	description
AT%R	0, 1 / 0	rate change
	0	no rate change
	1	rate change

AT&H Halfduplex Simulation

A halfduplex simulation for duplex operation modes is defined acc. to ITU-T V.13. If the control line S2 is activated at the local modem the remote modem receives a control sequence. Then the remote modem activates the report line M5. Any resetting of S2 causes a reset of M5 at the remote modem. The control sequences S2 on or S2 off are transferred as data to the remote modem. If your DTE runs a protocol these data should not cause any problems. Halfduplex simulation acc. to V.13 is only applicable for direct mode.

command	parameter/default	description
AT&H	0, 1 / 0	halfduplex simulation
	0	no halfduplex simulation
	1	halfduplex simulation acc. to ITU-T V.13

3.9 Module Functions**ATSET(n)=x Software Selected DIP Switches**

The command allows for software selection of features that can be set with the DIP switches in compatible mode. Please refer to the switches table of the compatible modems. The table of modulation procedures (ATF(n) command) indicates the valid modulation procedure. The command is a simple bridge between compatible and software mode. The ATSET command allows for setting of different switches thus facilitating to adjust all DIP switches with just two ATSET commands. The features that may be selected with AT commands are not applicable for the ATSET command.

Example: ATSET 1, 2, 3 = ON
ATSET 11, 12 = OFF (DIP switches 2.1 and 2.2)

command	parameter/default	description
ATSET(n)=x	0...14 (0...18 for V.22bis operation) x = ON or OFF	software selected DIP switches

ATSET? Inquire DIP Switches Setting

The command is employed to inquire the modem settings adjusted with the DIP switches in compatible mode. After reading all 14 (or 18) parameters the modems issue an ON or OFF.

Example: ATSET? (CR)

3.10 Password Protection**AT%M(n) Password Protection**

The super password that is stored in the short dialing register Z00 is used for implementation of the AT%M command and for any alterations of callback numbers and passwords during operation in a password protected mode. During active password protection passwords or short names are not displayed when the command AT&Z? was typed.

command	parameter/default	description
AT%M(n)	0, 1 / 0	password protection
	0/super password	no password protection
	1/super password	password protection

The password protection comes with the following features:

- 3 operation modes:
 - A) - without callback (direct switching after password input)
- with callback (callback with number specified by the password)
 - B) with direct callback; the modem expects the subscriber to type a callback number after password input. Direct switching to the HOST is possible:

user action	modem reaction
RETURN	callback with number specified by password (AT&Z(n))
(number) RETURN	callback with phone number
0 RETURN	direct switching to HOST

C) with forced callback

user action	modem reaction
RETURN	callback with number specified by password (AT&Z(n))
(number) RETURN	callback with phone number

- max. 20 callback numbers
- protected alterations due to super password
- hacker protection. Register S101 counts invalid password inputs.

Passwords and callback numbers are stored in the 20 short dial registers Z00 ... Z19. The short name will be used now as a password. The password stored here is the super password used with the AT%M command. To distinguish operation modes the callback number must be prefixed with a combination of two characters.

Operation mode labeling:

ZA - operation mode A
 ZB - operation mode B
 ZC - operation mode C

Example:

AT&Z1=ZC123456789/GEHEIM

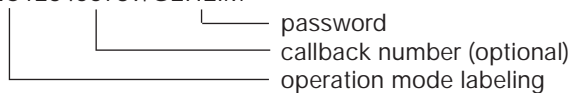

Attention: The password may not exceed 11 characters. Small letters are transferred to capital letters when typing the password.

Example:

input: AT&Z1=123456789/geheim (ENTER)
 AT&Z1=123456789/GEHEIM

This conversion is performed during password configuration and during operation as well (at the online password polling). The operation mode labelling may be different for any of the 20 password memories thus allowing for different access modes for any password.

Additional information operation mode A:

The operation mode labeling is available with the software version 4.00. To guarantee for downward compatibility configuration is possible without a prefixed label as well. In this case the modems behave according to operation mode A. Passwords and callback numbers must be typed as shown below:

- without callback AT&Z2=/PASSWORD
- with callback AT&Z3=T05116747390/SUPPORT

Additional information operation mode B and C:

Central office access has to be considered if the modem operates inside a PABX system. As the central office access number is not known to any person it can be defined as a dial prefix using the command AT%MP=xxx. An authorized caller has to enter only his individual callback number (area code and subscriber number). Now the modem sets the prefix for the callback number automatically whenever needed.

Example: The modem is set up for operation mode ZB with password protection. The PABX system needs the prefix number 89 for central office access and the modem waits for the ringing tone after central office access (parameter: W).

1 step: enter passwords
AT&Z0=ZB123456/MEIER
AT&Z1=ZB05116747390/WURST
...
AT&Z9=ZB89W08955806/GEIGE

2 step: select prefix
AT%MP=89W

3 step: activate password protection
AT%M1/MEIER

Dial up procedure:

1. An external subscriber establishes a connection to the modem.
2. Enter GEIGE as password.
3. Enter 05116747590 as callback number.

The connection is being deestablished after typing the new calling number. Now the modem generates the dialing command ATD05116747590 and initiates the dialing procedure.

The callback number defined in Z9 will not be altered by this procedure! The standard callback number should be stored in the short dial register for this reason!

If the new callback number starts with a „ . “ (point) the calling number does not begin with a dialing prefix. This feature is important for calls inside the PABX system to suppress the central office access.

Additional information operation mode C:

If you do not type a callback number for operation mode ZC (AT&Z(n)=ZC/PASSWORD) the modem prompts for a callback number after password request.

General information:

- If you type a password without a callback number the prefixed „/“ is very important.
- If a number storage does not contain any operation mode label and no callback number the modem connects directly to the HOST if a valid password is being entered.
- After dial up to a password protected modem the subscriber is prompted with „Passwort“ to enter a password. The connection will be deactivated:
 - if you do not enter a valid password after 3 minutes or
 - if 3 invalid passwords have been entered.
- A HOST connection is established after typing of a valid password or if a successful callback is reported (DCD is active)
- At password protected operation the RING report and the state of the interface line RI (M3) are not transferred to the HOST. If you need these reports nevertheless refer to register 102.



AT%MP=(x) Define Dial Prefix

The command defines the dial prefix (for central office access) employed with PABX systems. This definition is only necessary for password protection with callback numbers to be freely defined.

Example: AT%MP=T89W

The parameters listed below are valid:

parameter	description
P	pulse dialing
T	tone dialing
0...9	dialing digits
>	ground key function
& and !	flash pulse (only for tone dialing)
: and W	wait for dial tone

The dial prefix has max.10 characters. The command AT%MP= erases the prefix. With AT%MP? you can display the current setting.

3.11 Remote Configuration

AT%P Change Password

The command AT%P/configuration password initiates an alteration of the current configuration password. The modem prompts the current and then the new password. The factory default setting is FERN (REMOTE) which will be used again whenever you load one of the basic settings. The password must have at least 4 and max. 11 characters.

AT%F Initiate Remote Configuration

Due to safety reasons remote access is only possible during reliable mode. Register S45 of the remote modem has to be set to 1 (ref. to the chapter "remote configuration").

Change to command mode (+++) first. Then transmit with AT%F your password that was stored with AT%/P. You can use any other password using the command AT%P/Paßwort. A CONNECT REMOTE report indicates that the remote modem has switched to remote access mode. Now the local modem switches back automatically to transparent mode. Any AT command is now being sent to the remote modem which acknowledges with an %OK or %ERROR. Then all changed settings must

be saved with AT&W(n). The connection is terminated with an ATZ(n) command and the new configuration is loaded. If you do not type the ATZ(n) command the remote modem keeps the latest settings until the next POWER ON.

Attention: As remote configuration is only applicable for reliable mode the commands ATF(n) (n= 4 or 5) and AT\N1 prevent further remote accesses!

Remote modem configuration is possible even with any other external modem just by transmitting a BREAK signal in transparent mode. Then you have to type the configuration password within 10 secs. terminated with a carriage return (CR). Successful initiation of remote configuration is indicated by a %OK report.



3.12 Loudspeaker

Attention: The commands described below are only valid for the standalone modem LOGEM® 928.

ATL(n) Loudness

The built-in loudspeaker can be set in three different stages.

command	parameter/default	description
ATL(n)	0...2 / 1	loudness
	0	low
	1	medium
	2	high

ATM(n) Loudspeaker Setting

The loudspeaker can be adjusted to control establishment of connections.

command	parameter/default	description
ATM(n)	0...2 / 1	loudspeaker setting
	0	loudspeaker OFF
	1	ON during dialing and dial up
	2	constantly ON



4 Register Allocation 105

4.1 Modem Memory Locations 105

4.2 Register Description 107





4 Register Allocation

4.1 Modem Memory Locations

The modems feature integrated data memories for data protection (e.g. configurations, phone numbers, individual labelling etc.).

ROM Read Only Memory

The internal ROM of the modems is a read only memory containing the basic settings 0 ... 7. These data is being kept even after deactivation of the modems power supply and may not be altered. The basic setting "n" can be saved to the RAM of the modem with the command AT&F(n).

EEPROM Electrically Erasable Programmable ROM

The internal EEPROM is a read/write memory that saves all stored data even after deactivation of the device. You can change the EEPROM content. The EEPROM stores all short dial register contents (phone numbers) directly. With the command AT&W(n) you can define register contents (defaults) of your application in the EEPROM. Max. 3 settings (user settings 0 and 1 and basic setting 8) may be stored in the EEPROM.

RAM Random Access Memory

The internal RAM is a read/write memory that contains any current data (working storage). Any changes concerning modem configuration during operation are stored here. The working storage is being erased after deactivation of the device. Any new user defined settings have to be stored in the EEPROM for this reason. Data protection is performed with the command AT&W(n).

REG



Chapter 4

factory defaults

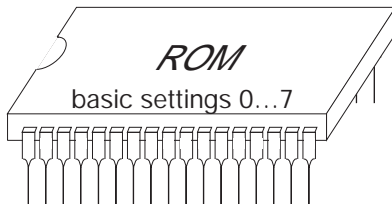

modem
RAM

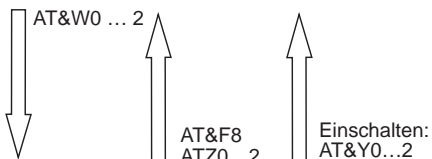
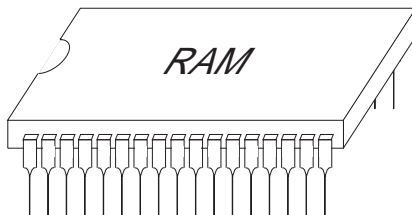

user settings

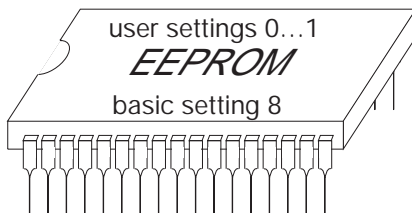

REG
Chapter 4

4.2 Register Description

The modems feature a number of registers to store information and to manipulate the operation of the modem.

To adapt the modem to individual applications you can change the default parameters using the command `ATS(n)=xxx`.

With the command `AT&W(n)` register values may be saved permanently in the EEPROM. Data stored in the EEPROM are not erased even after deactivation of the power supply.

The values stored here are read out automatically from the modem EEPROM to the working storage of the modem after typing the command `ATZ(n)` or switching the device on.

The 8 basic settings are stored in a read only memory (ROM). They are not erased even after alteration of the data stored in the EEPROM. The factory default can be recalled by typing the command `AT&F(n)`.

To define a modem setting after POWER ON you can select a user setting with the command `AT&Y(n)` ($n = 0...2$).

Attention! Registers not documented here must not be altered. Any changes might cause malfunctions of your modem.

REG



Chapter 4

S0 Number Of Rings

The register specifies the number of rings for automatical answering. If the register is set to 0 the modems do not answer automatically.

register	values / default	description
S0	0...5 / 1	number of rings

S1 Count Of Rings

The register counts the number of recognized rings. It is set to 0 if more than 6 secs. have passed after the last ring.

S2 ESCAPE Character

The register defines the escape character. After a sequence of three consecutive escape characters (+++) the modems go from transparent to command mode.

register	values / default	description
S2	0...255 / 43 (ASCII "+", 2Bhex)	escape character

S3 Carriage Return (CR)

The register specifies the carriage return character. This setting is only valid for command mode.

register	values / default	description
S3	0...255 / 13 (0Dhex)	carriage return

S4 Line Feed (LF)

The register specifies the line feed character. This setting is only valid for command mode.

register	values / default	description
S4	0.255 / 10 0Ahex)	line feed

S5 Backspace

Backspace character setting for command mode application.

register	values / default	description
S5	0...255 / 8 (08hex)	backspace

S7 Carrier Delay

During dial up the modem waits for a carrier from the remote modem. The carrier delay can be set in register S7. The modem disconnects when the carrier delay time is exceeded.

register	values / default	description
S7	10...100 / 100 (unit: secs.)	carrier delay

S8 Dial Pause

During processing of the dial character sequences ATD or CRN the modem pauses after recognition of the comma (AT command set) or equal sign (V.25bis command set) for the time specified in register S8 before it commences with the dial string.

register	values / default	description
S8	1...30 / 2 (unit: secs.)	dial pause

S10 Carrier Loss Time

The modem terminates a data connection at carrier loss. Register S10 defines the duration of the carrier loss after which the modem disconnects.

register	values / default	description
S10	2...100 / 50 (5 s) (unit: 100 ms)	carrier loss time

S12 Break Sequence Guard Time

The register defines the time (in ms) the modem has to wait before and after a break sequence to be able to detect the break sequence. A break sequence consists of three consecutive break characters to be specified in register S2. The register is not valid for direct mode.

Example: ATS12 = 45 (CR), guard time 45 x 20 ms = 900 ms

register	values / default	description
S12	0...255 / 45 (900ms) (unit: 20 ms)	break sequence guard time

S20 Dial Abort Character

The register defines the modem operation with receiving of characters at the V.24 interface during the dialing process.

register	values / default	description
S20	0...255 / 255	dial abort character
	0	the modem ignores all characters coming from the V.24 interface during dialing
	1...254	dialing is aborted if the modem receives a character with the selected decimal value
	255	dialing is aborted whenever the modem receives an arbitrary character

S26 S2/M2 Delay Time

If you have selected S2/M2 simulation with the command AT&R0 the register specifies the duration of the S2/M2 delay.

register	values / default	description
S26	0...255 / 4 (40ms) (unit: 10 ms)	S2/M2 delay time

S37 Inactivity Timeout

The register specifies the period the modem waits for received data or data to be transmitted before disconnecting. If the register is set to 0 the modem does not disconnect. This register is not applicable for direct mode.

register	values / default	description
S37	0...255 / 0	inactivity timeout
	n = 0	no abortion
	n > 0	abortion after n minutes

S39 XON Character

The character code for the XON character is specified in register S39. The XON character triggers the data terminal equipment to transfer further data.

register	values / default	description
S39	0...255 / 17 (CTRL-Q,11hex)	XON character

S40 XOFF Character

The character code for the XOFF character is specified in register S40. The XOFF character triggers the data terminal equipment not to transfer further data.

register	values / default	description
S40	0...255 / 19 (CTRL-S,13hex)	XOFF character

S45 Remote Configuration

The register specifies if the modem is preset for remote access activities.

register	values / default	description
S45	0, 1 / 0	remote configuration
	0	disable remote configuration
	1	enable remote configuration

S50 Modulation and Transmission Procedures

The content of register S50 correspond to the setting of AT command ATF(n).

command	description	valid switches table for ATSET(n)=x command
ATF 0	as ATF255	
ATF 1	V.21 (300/300 bit/s, dx)	LGM 1200H1
ATF 2	V.22 (1200/1200 bit/s, dx)	LGM 2400D2
ATF 3	V.22bis (2400/2400 bit/s, dx)	
ATF 4	V.23 (fixed 75/1200 bit/s, dx)	LGM 1200H1
ATF 5	V.23 (fixed 1200/75 bit/s, dx)	
ATF 20	V.32	
ATF 21	V.32 (fixed 4800 bit/s, dx)	
ATF 22	V.32 (fixed 7200 bit/s, dx)	
ATF 23	V.32 (fixed 9600 bit/s, dx)	
ATF 25	V.32bis	
ATF 26	V.32bis (fixed 12000 bit/s, dx)	
ATF 27	V.32bis (fixed 14400 bit/s, dx)	
ATF 30	V.Fast-Class (V.FC)	
ATF 31	V.FC (fixed 14400 bit/s, dx)	
ATF 32	V.FC (fixed 16800 bit/s, dx)	
ATF 33	V.FC (fixed 19200 bit/s, dx)	
ATF 34	V.FC (fixed 21600 bit/s, dx)	
ATF 35	V.FC (fixed 24000 bit/s, dx)	
ATF 36	V.FC (fixed 26400 bit/s, dx)	
ATF 37	V.FC (fixed 28800 bit/s, dx)	
ATF 40	V.34	
ATF 41	V.34 (fixed 2400 bit/s)	
ATF 42	V.34 (fixed 4800 bit/s)	
ATF 43	V.34 (fixed 7200 bit/s)	
ATF 44	V.34 (fixed 9600 bit/s)	
ATF 45	V.34 (fixed 12000 bit/s)	
ATF 46	V.34 (fixed 14400 bit/s)	
ATF 47	V.34 (fixed 16800 bit/s)	
ATF 48	V.34 (fixed 19200 bit/s)	
ATF 49	V.34 (fixed 21600 bit/s)	
ATF 50	V.34 (fixed 24000 bit/s)	
ATF 51	V.34 (fixed 26400 bit/s)	
ATF 52	V.34 (fixed 28800 bit/s)	
ATF 253	autom. detection of modulation procedure incl. V.32bis	
ATF 254	autom. detection of modulation procedure (highspeed, starting with V.32)	
ATF 255	autom. detection of modulation procedure (all modulation procedures) default setting	

S51 V.24 Interface Rate

The register is not applicable for direct mode, ref. to command AT+VAN1.

register	values / default	description
S51	2...15, 20 / 255	V.24 interface rate
	0	idle
	1	idle
	2	300 bit/s
	3	1200 bit/s
	4	2400 bit/s
	5	4800 bit/s
	6	7200 bit/s
	7	9600 bit/s
	8	12000 bit/s
	9	14400 bit/s
	10	16800 bit/s
	11	19200 bit/s
	12	38400 bit/s
	13	57600 bit/s
	14	76800 bit/s
	15	115200 bit/s
	20	programmable (n x 800 bit/s, ref. to register S52)
	255	automatical detection (transmission rates for values 2...13 are recognized)

S52 DTE Baudrate Multiplier

If register S52 is set to the value 20 the DTE baud rate is acc. to the register setting. The baud rate is calculated as follows:

$$\text{Baud rate} = \text{value of register S52} \times 800 \text{ bit/s}$$

Example: S52 = 36 S51 = 20

$$\text{DTE baud rate} = 36 \times 800 \text{ bit/s} = 28800 \text{ bit/s}$$



S54 Function of Da/Te Button

The register defines the function of the Da/Te button at the front plate of the modems. The button is designed to perform the functions listed below:

register	values / default	description
S54	0...5 / 1	function of Da/Te button
	0	activate test loop
	1	data button
	2	direct call
	3	direct call / disconnection
	4	data button / disconnection
	5	button locked

Description of the functions:

Activate test loop: A remote test loop is switched at an existing connection. If the modem is in command mode (OFFLINE) the local loop is switched.

Data button: The modem accesses the line after manual dial up if the button is pressed. Disconnection is possible with DTR/S1.

Direct call: The modem dials the number specified with the command AT&Z0=xxx. An existing connection is terminated with DTR/S1 (ref. to AT&D(n)).

Direct call / disconnection: The modem dials the number specified with the command AT&Z0=xxx. An existing connection is terminated by pressing the Da/Te button again.

Data button / disconnection: The modem accesses the line after manual dial up if the button is pressed. An existing connection is terminated by pressing the Da/Te button again.

Button locked: The button is disabled.

S60 Data Format Online Phase

register	values / default	description
S60	0...11 / 0	data format online phase
	0	8 data bits, no parity, 1 stopbit
	1	8 data bits, odd parity, 1 stopbit
	2	8 data bits, even parity, 1 stopbit
	3	8 data bits, no parity, 2 stopbits
	4	8 data bits, odd parity, 2 stopbits
	5	8 data bits, even parity, 2 stopbits
	6	7 data bits, no parity, 1 stopbit
	7	7 data bits, odd parity, 1 stopbit
	8	7 data bits, even parity, 1 stopbit
	9	7 data bits, no parity, 2 stopbits
	10	7 data bits, odd parity, 2 stopbits
	11	7 data bits, even parity, 2 stopbits

REG



Chapter 4

Due to the separated adjustment of data formats for the online and command phase the modems allow for operation with different data formats (i.e. with 7E1 during command phase and 8N1 for online phase). During reliable and auto reliable mode (MNP4/V.42) 8 data bits are transmitted constantly. The data format towards the terminal equipment is defined with register S61. This means that start, stop and parity bits are added at the local modem constantly.

The bits are transmitted transparently at data transmission in direct mode. During a transmission with the data format 8 data bits, even parity, 1 startbit and 1 stopbit all 11 bits are transmitted from the local modem to the remote terminal equipment. The data transmission rate is identical for these transmission procedures. Data flow control is not necessary in these cases.

S61 Data Format Command Phase

register	values / default	description
S60	0...11 / 0	data format command phase
	0	8 data bits, no parity, 1 stopbit
	1	8 data bits, odd parity, 1 stopbit
	2	8 data bits, even parity, 1 stopbit
	3	8 data bits, no parity, 2 stopbits
	4	8 data bits, odd parity, 2 stopbits
	5	8 data bits, even parity, 2 stopbits
	6	7 data bits, no parity, 1 stopbit
	7	7 data bits, odd parity, 1 stopbit
	8	7 data bits, even parity, 1 stopbit
	9	7 data bits, no parity, 2 stopbits
	10	7 data bits, odd parity, 2 stopbits
	11	7 data bits, even parity, 2 stopbits

The modems come with an auto parity detection feature for AT commands. Register S61 should be set to 0 as long as the terminal equipment operates with 10 bits per character.

The parity bit is being evaluated from the command data format and the modems retransfer reports with the same data format to the DTE.

At 9 bits/character and 11 bit/character the data format has to be set in register S61. If the data format is valid for the online phase as well register S60 has to be set accordingly.

For operation with V.25bis commands reports are transferred with 7 data bits, even parity, 1 startbit and 1 stopbit. The terminal equipment recognizes any 10 bit character format. If register S60 is not set to 0 autobaud has to be deactivated first (register S51).

S63 Dial Backup Reswitching

The register defines the duration period that is necessary for faultless V.21 data transmission on the leased line before the modem switches back from switched line to leased line operation.

register	values / default	description
S63	6...255 / 6 (unit: 10 secs.)	dial backup reswitching

This register value has to be set identically at both modems!

S65 Reswitching/Hour

The register defines the max. number of reswitching attempts per hour. The modem does not attempt further reswitchings when the max. number of attempts is reached. The register is designed to avoid permanent switchings at errored lines.

register	values / default	description
S65	1...255 / 4	reswitching/hour

S66 Reswitching/Day

The register defines the max. number of reswitching attempts per day. The modem does not attempt further reswitchings when the max. number of attempts per day is reached.

register	values / default	description
S66	1...255 / 16	reswitching/day

Attention! The features described on this side are only valid for dial backup operation. They are not applicable for the top rail version LGH 28.8D1.

S67 M3 Function at Dial Backup

If the register is set to 1 during leased line operation the report line M3 is active constantly thus allowing the DTE to detect any switching to switched line operation.

register	values / default	description
S67	0, 1 / 0	M3 function at dial backup
	0	M3 operates normal
	1	M3 is constantly active at leased line operation

S68 Establish Dial Backup Connection

The register S0 may not be set to 0 if call acceptance is needed.

register	values / default	description
S68	0...6 / 0	establish dial backup connection
	0	establish backup route automatically
	1	establish after pressing Da/Te button
	2	establish at activated S4/SEL line
	3	establish after pressing Da/Te button or at activated S4/SEL line
	4	as 1, call acceptance possible
	5	as 2, call acceptance possible
	6	as 3, call acceptance possible

Attention! The features described on this side are only valid for dial backup operation. They are not applicable for the top rail version LGH 28.8D1.

S80 Command Interpreter

register	values / default	description
S80	0...3 / 0	command interpreter
	0	AT commands
	1	AT/V.25bis commands (no autobaud!)
	2	AT/V.25bis commands and interface lines acc. to V.25bis (no autobaud, ref. to register S51)
	3	V.25bis/AT commands and interface lines acc. to V.25bis (no autobaud, ref. to register S51)

At S80=0 the function of the interface lines is acc.to the command settings of AT&C(n), AT&D, AT&R and AT&S.

At S80=1 or 2 the modem evaluates incoming commands acc. V.25bis if the command line does not start with an AT.

At S80=2 the interface signals are initialized automatically acc. V.25bis. The command interpreter operates generally acc. to V.25bis. The modem operates Hayes compatible whenever it detects a command line starting with an AT. In this case the command echo is activated again. If a command line does not start with an AT the modem operates in V.25bis mode again. This setting is designed for basic configurations if you employ e.g. AT commands for configuration (i.e. service PC) and need V.25bis commands for operations with the terminal equipment. Autobaud has to be deactivated before register S80 is set to 1, 2 or 3.

At S80=3 the modem issues V.25bis reports after POWER ON. DNL sequences are supported.



S81 Dialing Mode

register	values / default	description
S81	0, 1 / 0	dialing mode
	0	with BLACKLISTED
	1	with 30 secs. inter digit time

Data transmission equipment with automatic dialing are not licensed for unrestricted dialing inside the German network. At dialing modes with BLACKLISTED the modem is blocked after 12 unsuccessful dial attempts. The single dialing procedures are separated by different inter digit times.

The dialing mode 1 is designed for initiating a new dialing attempt every 30 secs.. If the terminal equipment attempts a new dialing within the 30 secs. delay the modem issues a DELAYED CALL report.

S90 FAX Transmission Rate

register	values / default	description
S90	0...5 / 5	FAX transmission rate
	0	2400 bit/s
	1	4800 bit/s
	2	7200 bit/s
	3	9600 bit/s
	4	12000 bit/s
	5	14400 bit/s

The register defines the max. transmission rate for fax connections. The transmission rate to be utilized effectively is negotiated by the modems. The register should be adjusted to lower rates if the addressed fax machines do not support higher transmission rates in order to reduce handshake timeouts.

S91 ECM Mode for FAX Operation

register	values / default	description
S91	0, 1 / 1	ECM mode for fax operation
	0	no error correction
	1	error correction

If your fax software does not support the ECM mode you can activate error correction by typing the command `ATS91=x` using a terminal. Data protection is disabled if register S91 is set to 0. If the register is set to 1 the modems support data protection. The modems negotiate during dial up if the connection is performed with data protection.

The duration of an error protected connection may be up to 30% longer as transmitted data is permanently acknowledged during ECM mode.

The setting of register S91 is overwritten if your fax software employs the `AT+FECM` command.

Any alterations of the register contents only get active after `POWER ON` or with the `ATZ` command. The changed register value has to be saved with `AT&W(n)`.

S100 Echo Character at Password Protection

register	values / default	description
S100	0...255 / 42 (ASCII „*“, 2Ahex)	echo character at password protection

The register specifies the echo character to be retransmitted after password inquiry to the calling station. The factory default is „*“. Character echo is disabled if 0 is selected.

S101 Password Protection Counter

The register content is augmented by the value 1 after every disconnection that was caused by an invalid password thus allowing to protect the DTE against unauthorized accesses. The register is reset at `POWER ON` or by typing `ATS101=0`.

S102 M3 at Password Protection

register	values / default	description
S102	0, 1 / 0	M3 at password protection
	0	M3 is not reported
	1	M3 is reported

The register is important for applications with activated password protection. The terminal equipment does not detect an existing connection if the register is set to 0 unless a valid password was entered after the establishment of the connection. At S102=1 the interface signal M3/RI is transferred to the terminal equipment. This is important for terminal equipment that sets (M3/RI) S1/DTR only at an incoming call to establish a connection.



REG

Chapter 4

5	V.25bis Commands	125
5.1	Reports	125
5.2	Dialing and Telephone Functions	127
5.3	Modem Configuration with V.25bis	131
5.3.1	DNL Command for LGM 1200H1 Operation	132
5.3.2	DNL Command for LGM 2400D2 Operation	132





5 V.25bis Commands

The compatible mode operates only with V.25bis commands. At software mode operation you can select either AT or V.25bis commands. Changing from AT to V.25bis is possible by setting register S80 to 1 or 2.

V.25bis commands are terminated with LF (line feed) or CR (carriage return). There is no character echo.

5.1 Reports

INC Incoming Call

The modem signals an incoming call with an INC report. If you do not disregard with the DIC command within 1 sec. the modem accepts the call.

VAL Valid Input

The incoming command is valid and will be processed.

INV Invalid Input

The incoming command is invalid and will not be processed.

DLC Delayed Call

The number is delayed as some unsuccessful attempts to establish a connection have been made.



CFIxy Fault Reports

The fault report CFI is followed by the two parameters „xy“ that indicate the fault type:

- CFIAB** Dial up or connection interrupted, as no dial tone was received within 20 secs. or the loop current has failed for more than 1 second.
- CFICB** The line is occupied; the modem is not ready for dialing.
- CFIFC** The modem is constantly blocked (after 12 unsuccessful dialing attempts). The modem can be reactivated by disabling the supply voltage and a new POWER ON.
- CFINT** No answer tone from the remote station within 100 secs. If necessary this period can be changed by setting register S7. This process is only possible with the AT command set.
- CFIET** Subscriber is busy. A connection cannot be established.



5.2 Dialing and Telephone Functions

CIC **Connect Incoming Call**

This command deactivates a DIC command given before. Incoming calls are accepted automatically by the modems.

DIC **Disregard Incoming Call**

The modems issue an INC report at an incoming call. If the user or the software does not initiate a DIC command to within 1 second to ignore the call the modem accepts the call.



CRI xxx;yyy Dial Request with Label

xxx = dial character sequence

yyy = subscriber phone number with national and area code

; = parameter separation character

The dial character sequence xxx consists of the complete telephone number of the subscriber and further parameters:

Valid parameters for dial character sequence xxx:

=	Causes a programmable dial pause. The period is specified in register S8.
<	Causes a pause of 1 second.
: and W	Dial pause recognition.
& and !	Causes a short line interruption (flash pulse). The feature can be activated at tone dialing only.
>	Activate ground key button for 255ms.
0...9	Characters for phone number or label.
#*ABCD	Special functions, only for tone dialing.
;	Separation character for phone number and label.
.	Group separation character.
SPACE	Group separation character (space character).
P	Pulse dialing.
T	Tone dialing.

Example for Automatic Dialing with CRI Command

PABX Subscriber

CRI = 0 : 0511 < 1234567 ; 49 511 987654 (LF)

CRI	dial request with label
=	wait for 3 s (programmable pause)
0	central office request (e.g. for PABX systems, with 0 here)
:	dial tone recognition
	subscriber telephone number:
0511	area code Hanover
<	wait 1 s (dial pause, optional)
12..	subscriber phone number
;	separation character
	individual label:
49	national code for Germany
511	area code Hanover
98..	individual phone number
LF	termination of character string



CRN xxx Dial a Phone Number

The subscriber telephone number is dialed automatically by the modem:

e.g. CRN 1234567890 (LF)

The parameters for the CRI command are valid for this dial character string. The L may be typed to dial the last telephone number.

CRS (n) Dial Up with Short Dial Register

The modem dials the dial character string xxx from the short dial register (n). Max. 20 short dial registers are available.

e.g. CRS 1 (LF)

PRN (n);xxx Set Short Dial Register

The command allows to store max. 20 dial character strings xxx (with 40 characters each) permanently. The information remains stored even after deactivation of the modem.

The parameters necessary for dialing (e.g. P, =, >, &etc.) are stored by the modem with the phone number:

e.g. PRN 1;=P1234567890 (LF)

The phone number 1234567890 is stored in the short dial register 1. The modem dials using pulse dialing procedures (P) and performs a dial pause (=) before dialing.

RLN List of Phone Numbers

This command displays the list of stored telephone numbers.



5.3 Modem Configuration with V.25bis

With the V.25bis command set the modem is not ready for reconfiguration. If the modem is in software mode (ref. to chapter 2) the modem is prepared for configuration with the comfortable AT command set. This is not possible in command mode. The most important modem settings may be adjusted using the DNL command set. This configuration is stored until the next S1 (DTR) change or whenever the modem is deactivated.

There is a separate DNL sequence for any modem type to be emulated in compatible mode. As an addition the modem to be emulated can be changed during the transmission phase. Any settings for V.25bis command phase are performed with DIP switches.

The DNL sequence starts with the DNL character string and a list of parameters that is separated by a semicolon (;). Parameters that are not to be changed are marked with an empty entry in the list (i.e. the list of parameters has two consecutive semicolons for this entry). It is very important that the characters appear in the valid position within the list of parameters. A list may be terminated premature if the following parameters are not necessary. The DNL command is terminated with a line feed (LF) as any V.25bis command.



5.3.1 DNL Command for LGM 1200H1 Operation

entry 1: 300/300, 75/1200, 1200/75
 entry 2: **A**synchronous
 entry 3: idle
 entry 4: **E**qualizer, **N**ormal
 entry 5: idle
 entry 6: **A** channel, **B** channel (V.21 transmitter)
 entry 7: not for use
 entry 8: **N**ormal, **S**timulated, **C**ontrolled
 (carrier control for V.21)

The **bold** characters are significant.

Example:

entry:	1	2	3	4	5	6	7	8
DNL	300/300	A;	L;	E;	M;	A;	;	S (LF)

5.3.2 DNL Command for LGM 2400D2 Operation

entry 1: 1200/1200, 2400/2400
 entry 2: **S**ynchronous, **A**synchronous
 entry 3: 8, 9, 10, 11, T1, T2, T4
 (asynchronous data bits or synchronous clock source)
 entry 4: 250 ms, 10 s (carrier timeout)
 entry 5: **O**verspeed, **N**ormal
 entry 6: **S**2, **C**onst. (carrier control for V.22)

Example:

entry:	1	2	3	4	5	6
DNL	2400/2400	S;	T;	250ms;	;	C (LF)

6	Dial Backup Features	135
6.1	Function of the Dial Backup Board	135
6.2	Installation of the DBU Board (Standalone Version) ..	135
6.3	Installation of the DBU Board (Rackmounted Version)	138
6.4	Telephone Access Line Selection	139
6.5	Access Line Alternatives	141





6 Dial Backup Features

6.1 Function of the Dial Backup Board

Attention! The dial backup features are not available for the top rail version LGH 28.8D1!

Due to the implementation of the dial backup board the *LOGEM*[®] 928 and the *LOGEM*[®] LGM 28.8D1 offer a further line interface. The line interface allows for 2 or 4 wire leased line operation. The additional line interface is not applicable for switched line applications. The dial backup board has to be employed for 4 wire leased line connections of group 0 and for private 4 wire leased line implementation. During dial backup applications the leased line connection is established generally using the dial backup (DBU) board. The secondary path (switched connection) is realized with the line interface of the main board. The DBU board has no DIP switches or jumpers as the board is detected automatically by the modem after installation.

6.2 Installation of the DBU Board (Standalone Version)

First remove all cables from your *LOGEM*[®] 928 and disconnect the telephone access line from your wall socket.

Now you can open the modem housing that consists of two basic parts that are connected with a snap-in bracket. Please open the housing very carefully using a screwdriver that has to be inserted into the slots at the bottom of the device. Make sure to insert the screwdriver at the outer side of the slot near to the devices housing in order not to damage the snap-in bracket. Open the snap-in brackets (ref. to fig. on the following page) carefully with a slight upward movement of the screwdriver. Open the housing carefully with your hands.



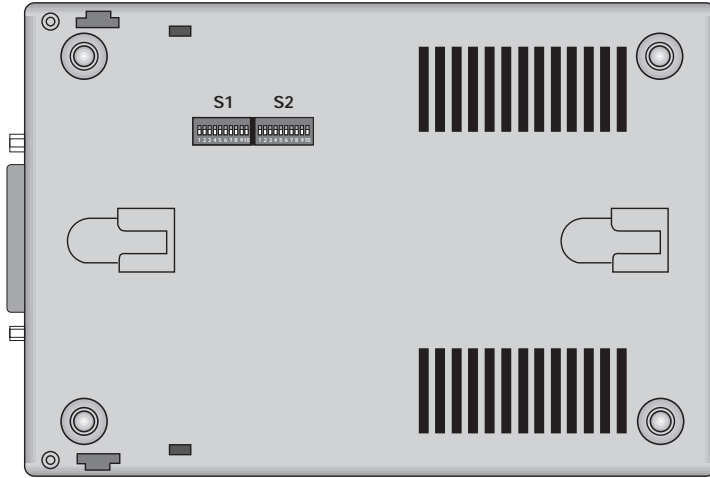

Fig.: 6.1 Bottom of the LOGEM® 928

Chapter 6

Place the modem in front of you as shown below and remove the jumpers BR3...BR5 at the position ST5. Then remove the blind jumper at the jack BU2 „Standleitung“ (leased line).

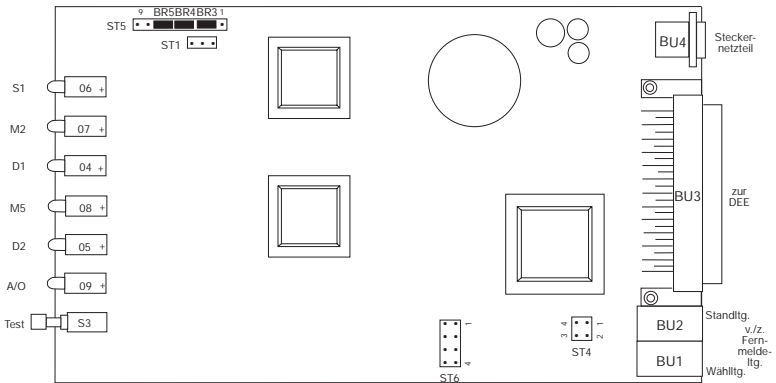

Fig.: 6.2 Main Board of the LOGEM® 928

The connectors ST4, ST5 and ST6 (ref. to fig. 6,2) provide the contact to the dial backup board.

Remove the DBU board from its black antistatical packaging. At the component side of the board are three connectors that fit into the connectors of the main board. Fix the DBU board with the component side down on the main board and check for proper installation. Fix the board with the safety screw M2 x 5 as shown in fig. 6.3.

Now the modem housing has to be closed. Insert the front side into the lid of the lower part of the casing and fix the two parts of the casing with a slight press until the fixing bracket snaps in with an audible sound.

Your modem is now operational again. Please refer to the following chapter for further information concerning dial backup applications.

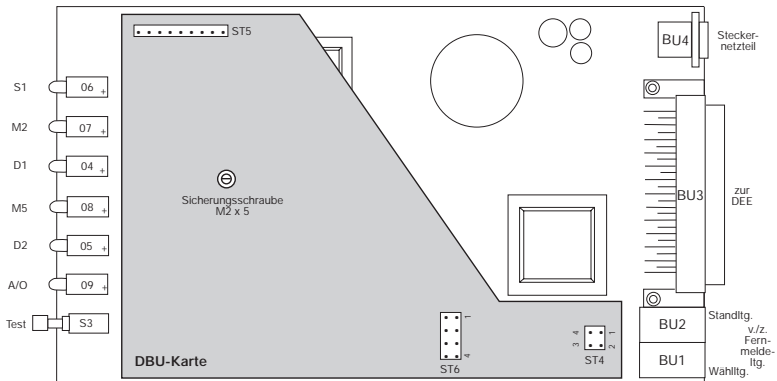

Fig.: 6.3: LOGEM® 928 with Dial Backup Board

6.3 Installation of the DBU Board (Rackmounted Version)

Remove all cables from your LGM 28.8D1 and extract the modem from its rack or the switching box. Remove the protective caps (9) to open the housing (ref. to fig. 6.4). Then extract the screws 4 and 5 using a screwdriver. Now you can take out the modem board from the casing.

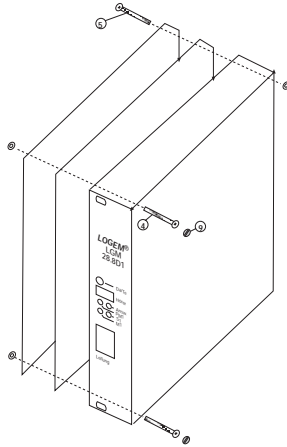

Fig.: 6.4 LGM 28.8D1 Installation of the DBU board

Place your modem if front of you as shown below and remove the jumpers BR3...BR5 at the position ST5. Then remove the jumpers BR6...BR11 at ST4. Keep the jumpers in a safe place as you need them after a deinstallation of the dial backup board.

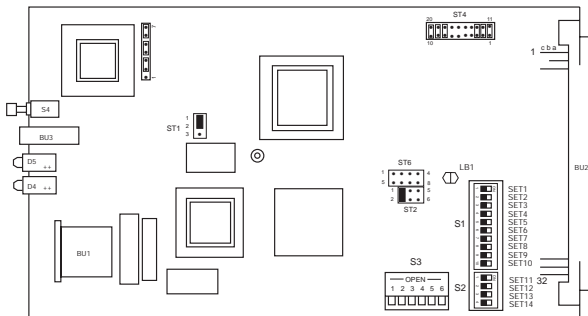

Fig. 6.5: Main Board of the LGM 28.8D1

The connectors ST4, ST5 and ST6 are designed to contact with the dial backup board.

Remove the DBU board from its black antistatical packaging. At the component side of the board are three connectors that fit into the connectors of the main board. Fix the DBU board with the component side down on the main board and check for proper installation. Fix the board with the safety screw M2 x 5 as shown in fig. 6.6.

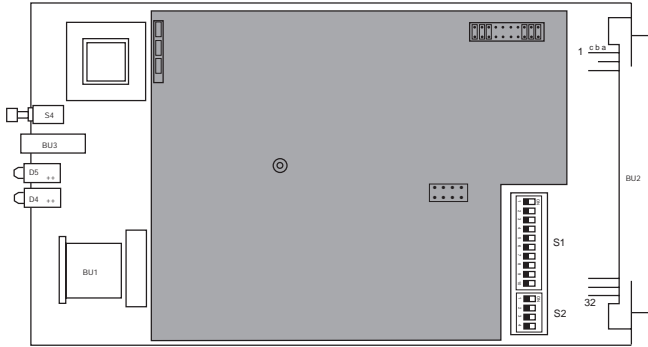

Fig. 6.6: LGM 28.8D1 with DBU Board



6.4 Telephone Access Line Selection

The 96pole connector is electrically allocated acc. to CEPT standard. The telephone lines are allocated according to the line operation mode.

In delivery state the modems are allocated in a way that is taking care of all possible switching alternatives (ref. to fig. 6.7).

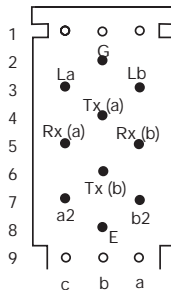

Fig. 6.7: Allocation of the 96pole Connector (delivery state)

For operation without a dial backup board the connectors La, Lb, E,G, a2 and b2 have to be allocated. A 2 wire leased line operation is possible via the La and Lb connectors as well. The FKS8 jack at the front panel of the LGM 28.8D1 is connected in parallel to the 96pole connector as well.

Please notice that only one access type is possible for your application! It is not applicable to utilize the FKS8 and the 96pole connector at the same time!

The optional DBU board comes with active Tx(a), Tx(b), Rx(a) and Rx(b) connectors. The Tx pins have to be connected for 2 wire leased line operation with the dial backup board.

The allocation of the VG connector changes according to the selected switching alternative if the modem operates at telephone access lines with CEPT standard (ref. to fig. 6.8). In such cases the allocation of the connectors is performed using jumpers that are installed at the dial backup board. The jumper positions for the three possible switching alternatives are printed on the reverse (contact) side of the DBU board. For the operation mode 2 or 4 wire leased line with dial backup the FKS8 jack is switched in parallel to the dial line connectors of the 96pole connector.

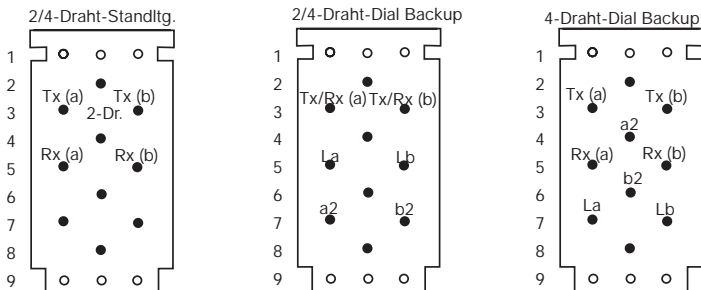
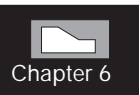

Fig. 6.8: Allocation acc. to CEPT

6.5 Access Line Alternatives

Allocation of the 96pole connector of the LGM28.8D1:

operation mode	La	Lb	G	E	a2	b2	Tx(a)	Tx(b)	Rx(a)	Rx(b)
dial line* DBU possible	c3 ¹	a3 ¹	b2	b8	c7	a7	b4	b6	c5	a5
2/4 wire leased line acc. to CEPT							c3 ²	a3 ²	c5	a5
2 wire leased line acc. to CEPT	c5	a5			c7	a7	c3	a3		
4 wire DBU acc. to CEPT	c7	a7			b4	b6	c3	a3	c5	a5

* delivery state

¹ in delivery state the connectors La and Lb are for 2 wire leased line operation as well

² at 2 wire leased line Tx = Rx

The jumpers on the DBU board have to be set according to the table shown above:

dial line: 1, 3, 5, 7, 9, 12, 15, 17, 19

leased line (CEPT): 2, 4, 5, 7, 19, 20

2 wire DBU (CEPT): 2, 4, 6, 8, 10, 13, 15, 17, 19, 20

4 wire DBU (CEPT): 2, 4, 5, 7, 11, 14, 16, 18, 19, 20

After finishing the settings for line switching please close the module housing as shown in fig. 6.4.





7	Applications	145
7.1	Remote Configuration Features	145
7.2	Leased Line Operation (Standalone Version)	151
7.2.1	Leased Line Operation (Rackmounted Version)	152
7.2.2	2 Wire Leased Line	153
7.2.3	4 Wire Leased Line	156
7.2.4	Leased Line Operation with Dial Backup	157
7.2.5	Leased Line Operation with Manual Dial Backup	158
7.3	Leased Line Operation	163
7.4	Lightning and Overvoltage Protection	167



7 Applications

7.1 Remote Configuration Features

The features listed below are of general importance for remote configuration of the modems.

Register S45: The register determines if the modems are ready for remote configuration which is only possible if register S45=1.

Password: During existing connections any modem has to be remotely configured must have a password. For this reason only authorized staff can perform any configurations with the modems. In delivery state the password "FERN" is preset. If you employ the remote configuration feature you should change the password using the command AT%P.

Data Protection: Remote configuration is only possible in reliable mode implementing the data protection protocols acc. to V.42 or MNP4.

Application 1:

The remote modem is configured from remote by a second modem:

Here the local modem has to be switched during the existing connection to command phase using the break sequence “+++”. The remote configuration starts after the modem has issued an OK report and after typing the command AT%F or AT%F/PASSWORD. After successful establishment the local modem reports CONNECT REMOTE.

From now on the remote modem interprets any input as a command. Any command line has to start with an AT and must be terminated with CR (carriage return). The AT commands in this manual are valid with only a few exceptions that will be mentioned later.

The modems are prepared for complete reconfiguration. To keep any changes permanently they must be stored with a AT&W command. New configurations get active after a reset (ATZ(n)) or OFF/ON switching of the power supply.

Attention! If you set the operation mode during configuration of the remote modem to e.g. V.23 (75/1200 bit/s, hx) or if you deactivate the data protection protocols for V.22bis operation and the parameters are saved with AT&W the device does not accept any further remote configurations after the connection is deestablished.



Example 1: Deactivation of Remote Configuration

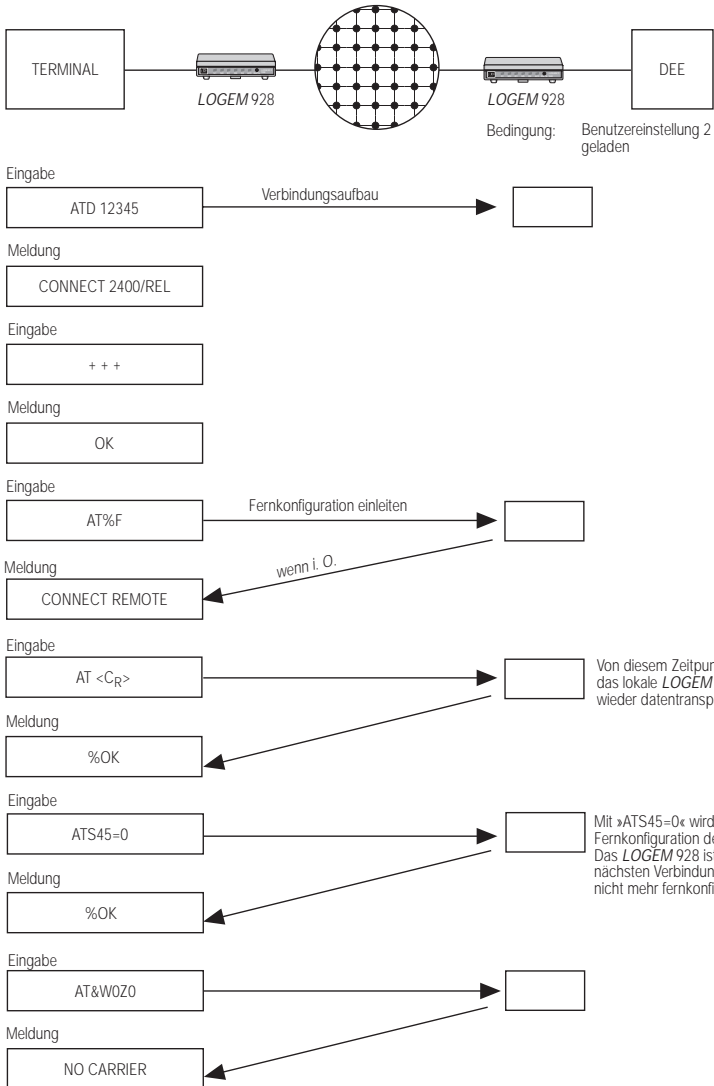

Application 2:

Complete reconfiguration after commissioning

During commissioning the user setting 2 or basic setting 8 have to be loaded at POWER ON. Now the terminal adapter is ready for remote configuration. The newly installed modem is called from a central using a terminal or PC. The operating modes may be set according to the actual application.

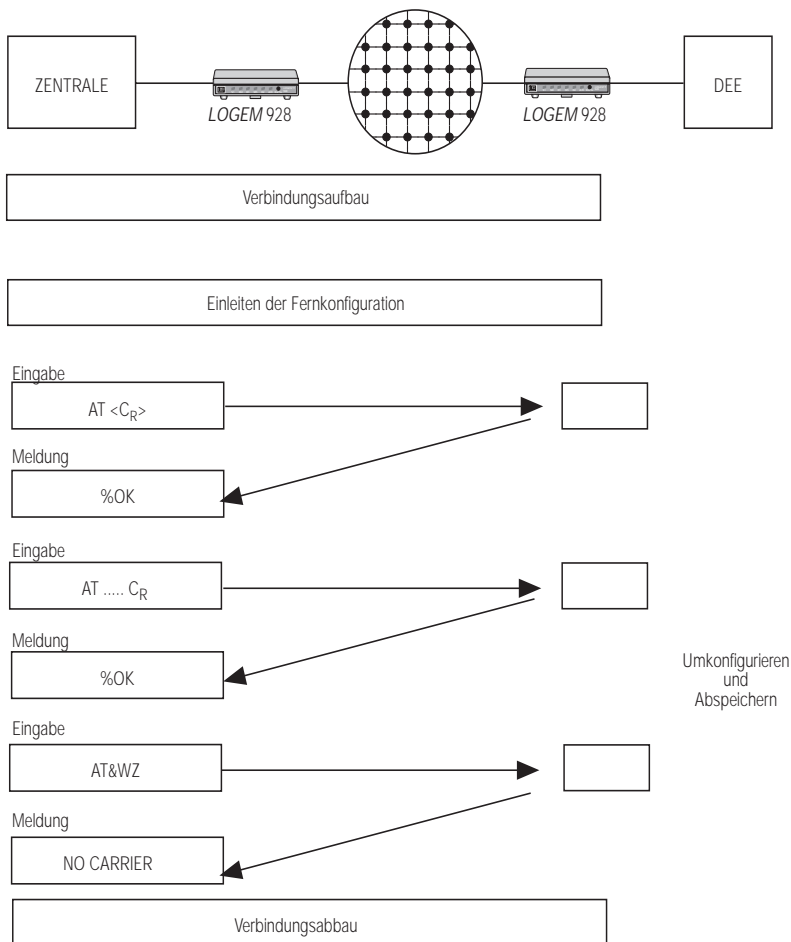

Example 2:

The remote modem is to be remotely configured by another modem. For this application the local terminal and the local data transmission software must be capable to send a BREAK signal.

Procedure: The local terminal has to send a BREAK signal after the establishment of a connection when both modems are in the data transmission phase. The remote configuration password terminated with a CR has to be part of the next 40 characters to be transmitted within 10 seconds. After detection of the password the remote modem acknowledges the remote access mode with an %OK. The further procedure is according to application 1 after the CONNECT REMOTE report.

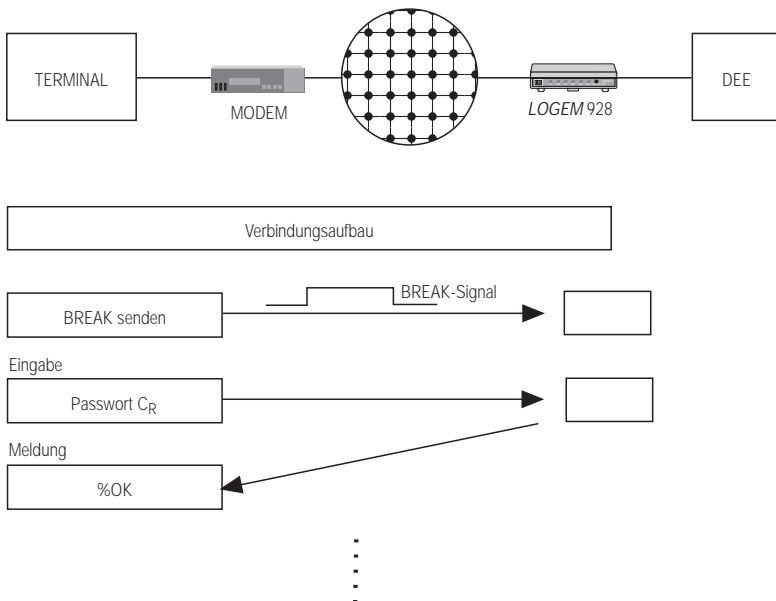

The commands listed here may not be used during remote configuration.

ATA
ATD
AT\B
AT\O
AT\Y
AT\Z

The commands will be acknowledged with a %ERROR report.

Attention:

- Any changes that have not been stored before terminating a connection are lost and have no further effect.
- If you have any doubts concerning the correctness of alterations you should terminate the connection without saving any parameters.
- As there are no limitations concerning remote configuration some commands only allow for single remote access.

Examples:

- At V.22bis operation the commands AT\N0 or AT\N1 deactivate the data protection protocols.
- Register S45 is set to 0.
- The modulation procedure is set to V.23 (75/1200 bit/s)



7.2 Leased Line Operation (Standalone Version)

The operation modes with the dial backup feature described here are not available with the top rail version LGH 28.8D1.

The modem supports the leased line operation modes listed below:

- 2 wire leased line (switched line interface)
AT commands:
AT&L1 (ATA/ATD), AT&L2 (originate), AT&L3 (answer)
telephone access:
RJ12 jack switched line - TAE6N jack, pin 1/2
- 2 wire leased line (dial backup board)
AT commands:
AT&L10 (originate), AT&L11 (answer)
telephone access:
RJ12 jack switched line - TAE6N jack, pin 1/2
- 2 wire leased line with dial backup
AT commands:
AT&L6 (originate), AT&L7 (answer)
telephone access:
RJ12 jack switched line - TAE6N jack
RJ12 jack leased line - TAE6N jack, pin 1/2
- 4 wire leased line (dial backup board)
AT commands:
AT&L4 (originate), AT&L5 (answer)
telephone access:
RJ12 jack leased line - TAE6N jack, pin 1/2 (TxD), pin 3/4 (RxD)
- 4 wire leased line with dial backup
AT commands:
AT&L8 (originate), AT&L9 (answer)
telephone access:
RJ12 jack switched line - TAE6N jack
RJ12 jack leased line - TAE6N jack, pin 1/2 (TxD), pin 3/4 (RxD)

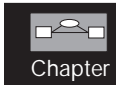

7.2.1 Leased Line Operation (Rackmounted Version)

The operation modes with the dial backup feature described here are not available with the top rail version LGH 28.8D1.

The modem supports the leased line operation modes listed below:

- 2 wire leased line (switched line interface)
AT commands:
AT&L1 (ATA/ATD), AT&L2 (originate), AT&L3 (answer)
switched line:
TAE6N jack (pin 1/2) or VG connector (a3/c3)
- 2 wire leased line (leased line interface)
AT commands:
AT&L10 (originate), AT&L11 (answer)
leased line:
VG connector (b4/b6)
- 2 wire leased line with dial backup (leased line interface)
AT commands:
AT&L6 (originate), AT&L5 (answer)
leased line:
VG connector (b4/b6)
switched line:
VG connector (a3/c3) or TAE6N jack (pin 1/2)
- 4 wire leased line (leased line interface)
AT commands:
AT&L4 (originate), AT&L5 (answer)
leased line:
VG connector (Tx: b4/b6, Rx: a5/c5)
- 4 wire leased line with dial backup (leased line interface)
AT commands:
AT&L8 (originate), AT&L9 (answer)
leased line:
VG connector (Tx: b4/b6, Rx: a5/c5)
switched line:
VG connector (a3/c3) or TAE6N jack (pin 1/2)



If the modem is equipped with the optional dial backup board it supports only 2 wire leased line operation via the switched line interface.

Please refer to the appendix for further information concerning the telephone access connectors and pin allocations.

During AT mode the leased line operation mode is selected using the command AT&L(n).

7.2.2 2 Wire Leased Line

The standard version of the modems allows for modem operation at a 2 wire leased line using the switched line interface. In this case line switching is performed using the TAE6N jack. The signal is connected to the pins 1 and 2. Such point to point connections allow for transmission ranges of about 10 km dependent from the implemented cable and the line routing.

Example 1:

Two terminal equipments are to be connected via a leased line. The DTE parameters are preset as follows:

data format:	8 data bits, no parity, 1 stopbit
speed:	38400 bit/s
data flow control:	hardware handshake RTS/CTS
data protection:	MNP 4
data compression:	none
line switching:	depends from S1 (DTR)

Configuration Modem A:

AT&F0 : load basic setting
AT\N5 : data protection MNP 4
AT\Q2 : data flow control RTS/CTS
AT&D3 : line access only at S1=ON
ATF40 : modulation acc. to V.34
ATS51=12 : interface rate 38,4 kbps
ATS60=0 S61=0 : set data format (N81)
AT%C0 : deactivate data compression
ATS20=0 : ignore characters during command phase
AT&L2 : modem operates as originator (master)
ATE0Q1 : command echo and reports OFF
AT&W : save configuration

Configuration Modem B:

AT&F0 : load basic setting
AT\N5 : data protection MNP 4
AT\Q2 : data flow control RTS/CTS
AT&D3 : line access only at S1=ON
ATF40 : modulation acc. to V.34
ATS51=12 : interface rate 38,4 kbps
ATS60=0 S61=0 : set data format (N81)
AT%C0 : deactivate data compression
ATS20=0 : ignore characters during command phase
AT&L3 : modem operates as answerer (slave)
ATE0Q1 : command echo and reports OFF
AT&W : save configuration

At a leased line configuration the modems have to operate with different channel allocations. It is not possible to establish a connection without setting the command AT&L(n) as a first operation. This adjustment is necessary for synchronous as well as for asynchronous applications. The example presented here is realized using a terminal or personal computer with a special data transmission software.



Example 2:

The modems are equipped with the optional dial backup board. The modems are to be adjusted without a terminal for 2 wire leased line operation. The connected terminal equipments operate synchronous with a max. transmission rate of 19200 bit/s. Modem A is connected to the HOST and sets the clock. **Synchronous mode (V.25bis)** is implemented for modem setting. The DIP switches S2.7 and S2.10 are set to **ON** and S2.6, S2.8 and S2.9 to **OFF** for this purpose. The other switches are set according to the necessary modem functions.

Example Setting (Standalone Version):

Modem A: DIP switch: S1.1, S1.3, S1.5, S1.7, S1.10 = **ON**
DIP switch: S1.2, S1.4, S1.6, S1.8, S1.9,
S2.1, S2.2, S2.3, S2.4, S2.5 = **OFF**

Modem B: DIP switch: S1.1, S1.3, S1.5, S1.7, S2.1 = **ON**
DIP switch: S1.2, S1.4, S1.6, S1.8, S1.9, S1.10,
S2.2, S2.3, S2.4, S2.5 = **OFF**

Example Setting (Rackmounted Version):

Modem A: DIP switch: S1.1, S1.3, S1.5, S1.7 = **ON**
DIP switch: S1.2, S1.4, S1.6, S1.8, S1.9, S1.10,
S2.1, S2.3, S2.4, S2.5 = **OFF**

Modem B: DIP switch: S1.1, S1.3, S1.5, S1.7, S1.10, S2.1 = **ON**
DIP switch: S1.2, S1.4, S1.6, S1.8, S1.9,
S2.2, S2.3, S2.4, S2.5 = **OFF**



7.2.3 4 Wire Leased Line

Leased line operation is only possible using the dial backup board that is available as an option. The telephone access connector for 4 wire operation is the „Standleitung“ (leased line) connector of the modems. This operation mode allows for connection of asynchronous and synchronous terminal equipment. Modem configuration is performed during mixed mode using the DIP switches or AT commands. Starting with the basic setting 0 the parameters AT&L4 (modem 1) and AT&L5 (modem 2) have to be set with other values to change the configuration. For synchronous mode (V.25bis) the 4 wire setting is selected using the DIP switches S1.7 and S1.8. During mixed mode (asynchronous) the switches S1.4 ... S1.6 and S2.5 have to be set for 4 wire leased line operation.



7.2.4 Leased Line Operation with Dial Backup

Leased lines are implemented with applications that need permanent access to data from a host system. At line failures access to current data might not be possible for a longer period. This is no problem if the modems are equipped with the optional dial backup board as they can backup the operation during failures or breakages on the route. Using a second modem chip the leased line is monitored permanently in parallel to the switched line. The switched connection is terminated if the leased line is operational again after failures. The modems switch back automatically to leased line operation.

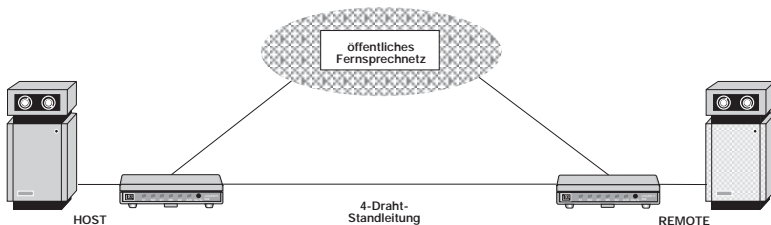

During normal operation the modems operate on a leased line (2 or 4 wire). The LED indicators A/O or ANS (rackmounted version) are not active for this operation mode.

The modems change automatically to switched line operation if the leased line is interrupted. The modem that has a phone number in his phone number storage Z0 initiates the establishment of a connection. To avoid any calling conflicts only one of the communicating modems may have an allocated number storage Z0. Otherwise the modem issues a BUSY report as the desired subscriber seems to be occupied. You may allocate further number storages as the modem would try to connect to other subscribers after an unsuccessful attempt to establish a connection. If a number storage is not allocated the modem starts again with the number from Z0 at the next establishment of a connection. The modem with a not allocated Z0 number storage waits generally as a slave for the next call to come. The LED A/O or ANS at the front side of the modem blinks at an established switched connection.

Attention! The utilization of the switched line is subject to special charges! This operation mode causes additional line costs!

During switched line operation the leased line is monitored constantly with an integrated V.21 modem. This modem switches back to leased line operation whenever it is able to transmit test data for the period specified in register S63. Register S64 determines if the switched line connection is terminated immediately after successful handshake on the leased line. The max. number of switchings between leased line and switched line is specified in the registers S65 and S66 to prevent permanent switching between both connections. The LED A/O or ANS at the front panel of the modems indicate the active connection procedure which can be reported to the terminal equipment using the interface line M3 (incoming call, RI). Register S67 must be set to 1.

	leased line	dial backup active
M3 state	active 1	inactive 0
indication A/O or ANS	OFF	blinks

Tab.: Signaling of Line Connection

7.2.5 Leased Line Operation with Manual Dial Backup

Often 2 or 4 wire connections are implemented for data transmission between local and remote computers. The modem establishes a switched line connection if the leased line is disturbed or broken. This causes additional line costs for the period the connection exists even if there is no permanent data transfer.

The configuration with manual dial backup allows for user defined establishment of a switched line connection even automatically or whenever necessary by setting the V.24 control line S4/SEL thus facilitating to set up a switched line connection by any DTE (SPC system, etc.).

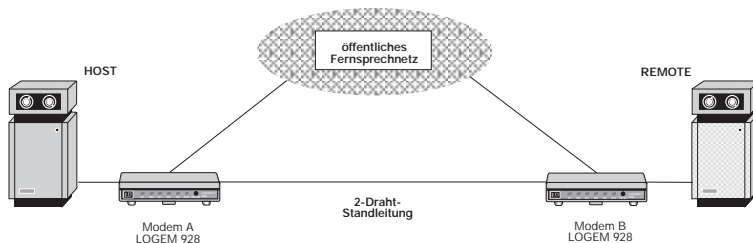

Example A:

Two computers are connected via a 2 wire leased line. At failures on the leased line a switched line connection is to be initiated and deactivated manually using the Da/Te button on the modems front panel. Here modem A calls modem B and data transmission between the computers is

performed with 19200 bit/s synchronous.

Modem configuration:

modem A	modem B	description
AT&F	AT&F	load basic setting
AT&Z0= (calling number B)		load calling number for switching connection to Z0
ATF48 \N1 &M1	AT&F48 \N1 &M1	modulation procedure (V.34/19200 bps), set operation mode and transmission proc.
ATS68=1		manual backup with Da/Te button
AT&L6	AT&L7	leased line 2 wire; master/slave
AT&D0 E0 Q1 S20=0 &W	AT&D0 E0 Q1 S20=0 &W	ignore DTR, echo/reports OFF and save

Now you must deactivate both modems and switch them on again. After a short POWER UP test the modems access the leased line and establish a connection.

At a leased line interruption for testing purposes the modems switch to the dial line interface without establishing a connection. Now the V.21 modem that is located on the dial backup board is switched to the leased line to check if the leased line is available again. The following factors are important:

- a) the V.21 test modem has to be detected at the remote side
- b) data transmission has to be free of errors for the period specified in register S63



A connection is established at activation of the data button of modem A. After a second pressing of the Da/Te button the switched connection is terminated again.

At an active switched connection the modem switches back to the leased line connection automatically whenever the leased line is operational again.

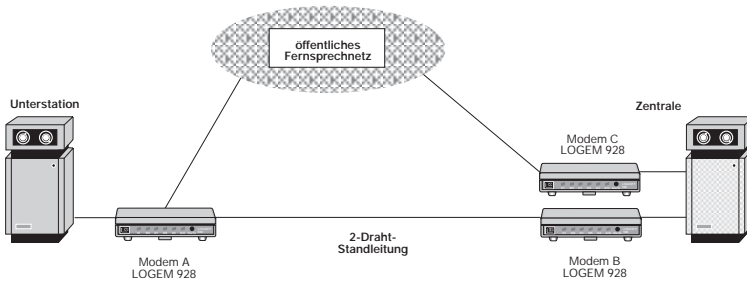

Example B:

A central station is connected to its remote partners via 2 wire leased lines. At failures on the leased line the remote station can establish a connection to the switched line modem C if necessary using the interface line S2/SEL. Moreover the central station can access the remote station using the separate modem C.

The transmission parameters have to be set as listed below:

- 2 wire leased line with dial backup (controlled via interface line S4/SEL) and automatic call acceptance
- asynchronous data transmission with 2400 bit/s
- data protection acc. to V42
- RTS/CTS data flow control



Modem configuration:

central (modem B)	remote (modem A)	description
AT&F	AT&F AZ&Z0= (calling number modem C)	load basic setting load calling number for dial connection in Z0
ATF3\N4%C	ATF3\N4%C	modulation procedure (V.22bis/2400 bps), V.42 data protection, no data compr.
ATS51=4	ATS51=4	V.24/V.28 transm. rate fixed 2400 bit/s
	ATS68=5	manual backup via S4/SEL with call acception
AT&L6	AT&L7	leased line 2 wire: master/slave
AT&D0 E0 Q1 S20=0 &W	AT&D= E0 Q1 S20=0 &W	ignore DTR, echo/reports OFF and save

Now you must deactivate both modems and switch them on again. After a short POWER UP test the modems access the leased line and establish a connection.

At a leased line interruption for testing purposes the modems switch to the dial line interface without establishing a connection. Now the V.21 modem that is located on the dial backup board is switched to the leased line to check if the leased line is available again. The following factors are important:

- a) the V.21 test modem has to be detected at the remote side
- b) data transmission has to be free of errors for the period specified in register S63



If the remote modem activates the interface line S4/SEL it initiates a dial connection to modem C.

The central station can establish a connection to the remote partner via modem C.

At an active switched line connection the leased line is reactivated whenever the integrated V.21 test modem detects it operational. In such a case the switched line is deactivated automatically.

Attention!

- 1) This operation mode with mutual call acceptance is not applicable if both modems try to establish a connection at the same time as they would detect the opposite station occupied.
- 2) Both modems have to be equipped with the dial backup boards.



7.3 Leased Line Operation

The modems are designed for operation at 2 wire leased lines (telekom specification: analog G/M1040 or better). At point to point connections without VF regenerators a transmission range of 10 ... 12 km is possible at a wire diameter of 0.8 mm. On good cables a transmission range of max. 15 km is possible.

Two modems can be switched in back to back operation for routes of about 20 ... 25 km.

Connection or transmission problems are often caused by exceeding basic noises, disturbing tones or pulses, low crosstalk attenuation or an exceeding basic attenuation. Basic attenuation should not be higher than 30 dB at the frequency band 300 ... 3100 Hz where the modems operate at V.22bis with 2400 bit/s. Please refer for leased line operation to the chapter overvoltage/lightning protection.



Example 1:

Leased line 2400 bit/s, asynchronous, 10 bits/character (sum of start, data, parity and stop bit), no data protection or data compression protocols, 3 wire interface to the terminal equipment (1. transmit data, 2. receive data, 3. operating ground)

Switches table LGM 2400D2 (V.22bis):

Modem 1 / DIP switches:

S1.5, S1.9, S2.9, S2.10 = **ON**

all other DIP switches = **OFF**

Modem 2 / DIP switches:

S1.5, S1.9, S2.1, S2.9, S2.10 = **ON**

all other DIP switches = **OFF**

- the LED S2 (RTS) shows green if the data terminal equipment (DTE) is ready to transmit and the control line is activated
- the LED A/O (ANS) blinks green if the modem switches the leased line and initiates the establishment of a connection (handshake) to the remote modem
- the LED M5 (DCD, report line) lights up at an existing modem connection (leased line)



Example 2:

For a testing installation the modems are not connected directly at the telephone access side. As the leased line has no attenuation in this case transmission errors might occur due to overdriving of the modem receiver. For this reason a resistor of about 470 ohms should be installed at each wire (ref. to fig. below).

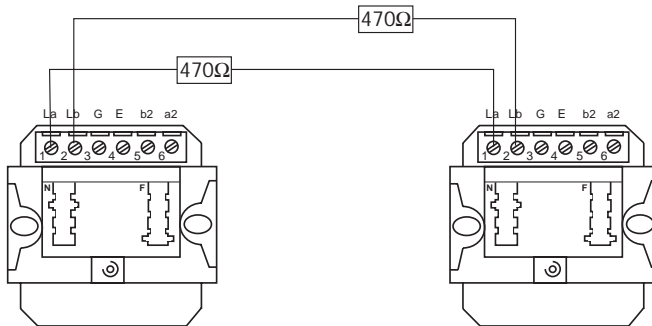
**Example 3:**

A leased line of about 25 km can be set up by switching of two modems in back to back operation for signal regeneration (ref. to fig. below).

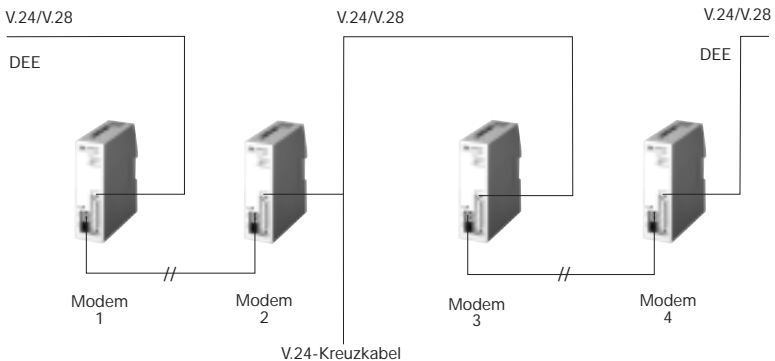

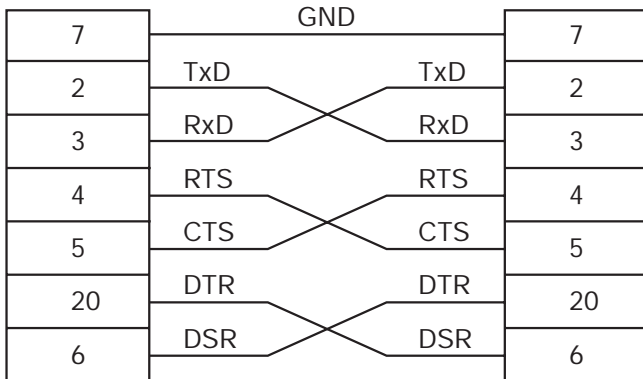

Tab.: Wiring Plan for Asynchronous Cross Cable

The modems 2 and 3 have to be connected for this application with a cross cable (zero modem cable). The cross cable is to be utilized for asynchronous application.

7.4 Lightning and Overvoltage Protection

Modem failures can be caused by discharges or overvoltages from the telephone access side or the operating voltage whenever lightning discharges occur. Electrical installations within a distance of 1.5 km are subject to hazards when thunderstorms occur due to electromagnetic fields and line overvoltages.

The modems feature a special protection against overvoltages from the telephone access side (ref. to block diagram below).

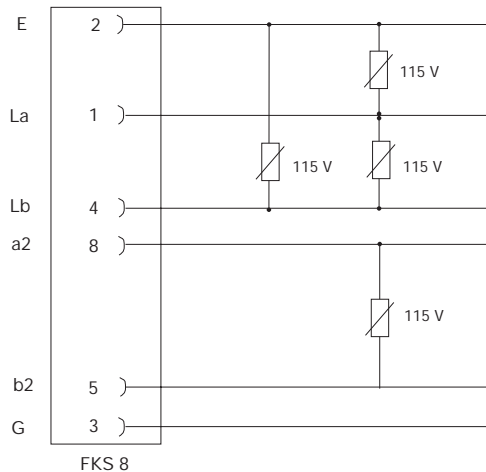

For leased line applications and especially for operation in areas with frequent thunderstorms further protection should be installed. Lightning protection is available (in Germany) from the manufacturers listed below:

Phönix Contact GmbH & Co.
P.O.Box 1341
32819 Blomberg

or

DEHN + Söhne GmbH
92306 Neumarkt/OPF
Tel. (09181) 901 - 0





8	Appendix	171
	Appendix A	
	Appendix B1	174
	Connection to a TAE 6NF Socket (Switched Line Operation)	174
	Appendix B2	
	Telephone Access Jacks.....	175
	Appendix B3	
	Telephone Access Jacks.....	176
	Appendix B4	177
	Telephone Access Jacks.....	177
	Appendix B3	
	Telephone Access Cable RJ12/TAE 6N	178
	Appendix B4	
	Telephone Access Cable FKS8/TAE 6N	179
	Appendix C1	
	Data Interface LGM 28.8D1	180
	Appendix C2	
	Interfaces LGM 28.8D1	181
	Appendix C3	
	V.24 Interface Allocations	182
	Appendix C4	
	Asynchronous Standard Connection Connection	183
	Appendix C5	
	Synchronous Standard Connection	184
	Appendix C7	
	Modem to Modem Cross Cable (asynchronous)	185
	Appendix C6	
	Allocation of the 25pole Sub D Jack	185
	Appendix C8	
	Modem Identification	
	Appendix D	
	ASCII Table	187
	Appendix E	
	Glossary	188
	Appendix F	
	Technical Data	191
	Appendix G	
	Index	193



8 Appendix

Appendix A Basic Settings

Basic Setting 0:

Switches	S2.6	S2.7	S2.8	S2.9	S2.10
	S3.2	S3.3	S3.4	S3.5	S3.6
	OFF	OFF	OFF	OFF	OFF

automatical detection of modulation procedure, V.42bis, btx-operation possible with transmission ranges < 2400 bit/s, AT commands, autobaud, asynchronous

```
F255 E1 L1 M1 Q0 X4 V1 P \Q2 \G0 \A1 \C3 \L0 \N3 \X0 \K3 \B3 %C1
%E1 %M0 %R0 &L0 &I0 &X0 &G0 &M0 &C2 &D2 &H0 &R1 &S1 &T5
S00=001 S01=000 S02=043 S03=013 S04=010 S05=008 S07=100
S08=002 S10=050 S12=045 S20=255 S26=004 S28=000 S37=000
S39=017 S40=019 S45=000 S50=255 S51=255 S54=001 S60=000
S61=000 S62=030 S63=006 S64=001 S65=004 S66=016 S67=000
S80=000 S81=000 S90=005 S91=001 S100=042 S101=000
S102=000
```

During this asynchronous setting the modems operate with automatical detection of the modulation procedure at the transmission side. Towards the data terminal equipment (DTE) the modem operates with automatical detection of the transmission rate (autobaud). The data format is set to 1 start bit, 8 data bits, no parity and 1 stop bit.

The ITU-T protocols V.42 and V.42bis are activated for safe data transmission. The modems remain in normal mode if the remote modem does not support any data protection protocols.

Modem reports are transferred in text form to the DTE. During command phase (AT commands) characters are sent as echoes to the DTE.



Basic Setting 1:

Switches	S2.6	S2.7	S2.8	S2.9	S2.10
	S3.2	S3.3	S3.4	S3.5	S3.6
	OFF	OFF	OFF	OFF	OFF

V.22bis, btx, AT commands, 2400 bit/s, asynchronous

```
F3 E1 L1 M1 Q0 X4 V1 P \Q2 \G0 \A1 \C0 \L0 \N1 \X0 \K0 \B3 %C1 %E1
%M0 %R0 &L0 &I0 &X0 &G0 &M0 &C2 &D2 &R1 &H0 &S0 &T5
S00=000 S01=000 S02=043 S03=013 S04=010 S05=008 S07=100
S08=002 S10=004 S12=045 S20=255 S26=004 S28=000 S37=000
S39=017 S40=019 S45=000 S50=003 S51=004 S54=001 S60=000
S61=000 S62=030 S63=006 S64=001 S65=004 S66=016 S67=000
S80=000 S81=000 S90=005 S91=001 S100=042 S101=000
S102=000
```

This basic setting allows for modem operation with btx applications at 2400 bit/s. Data protection protocols are deactivated and the modems operate in direct mode. During command phase the modems operate with AT commands.



Basic Setting 8 = User Setting 2

Switches	S2.6	S2.7	S2.8	S2.9	S2.10
	S3.2	S3.3	S3.4	S3.5	S3.6
	OFF	OFF	OFF	OFF	OFF

automatical detection of modulation procedure, V.42bis, btx-operation possible with transmission ranges < 2400 bit/s, AT commands, autobaud, asynchronous

```
F255 E1 L1 Q0 X4 V1 P \Q2 \G0 \A1 \C3 \L0 \N3 \X0 \K3 \B3 %C1 %E1
%M0 %R0 &L0 &I0 &X0 &G0 &M0 &C2 &D0 &H0 &R1 &S1 &T5
S00=001 S01=000 S02=043 S03=013 S04=010 S05=008 S07=100
S08=002 S10=050 S12=045 S20=255 S26=004 S28=000 S37=000
S39=017 S40=019 S45=001 S50=255 S51=255 S54=001 S60=000
S61=000 S62=030 S63=006 S64=001 S65=004 S66=016 S67=000
S80=000 S81=000 S90=005 S91=001 S100=042 S101=000
S102=000
```

In delivery state the basic setting 8 is identical to basic setting 0, as an addition remote configuration (register S45=1) is possible as well. The modem is operational without the control line S1(108). The command AT&W2 overwrites these values and allows for defining of an individual basic setting.

Appendix B1
Connection to a TAE 6NF Socket
(Switched Line Operation)

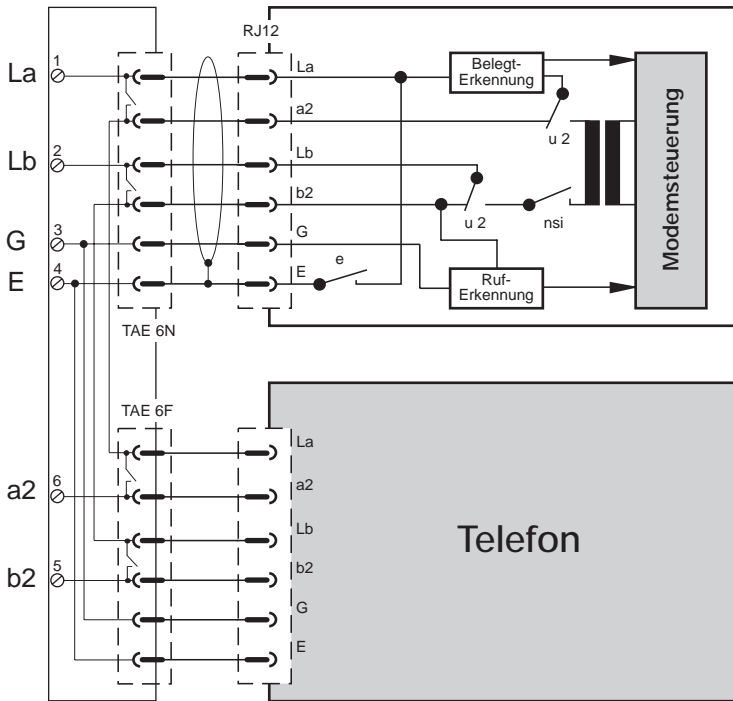
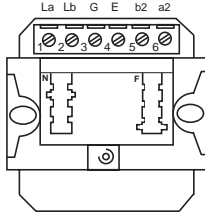

Chapter 8

Appendix B2
Telephone Access Jacks
LOGEM 928

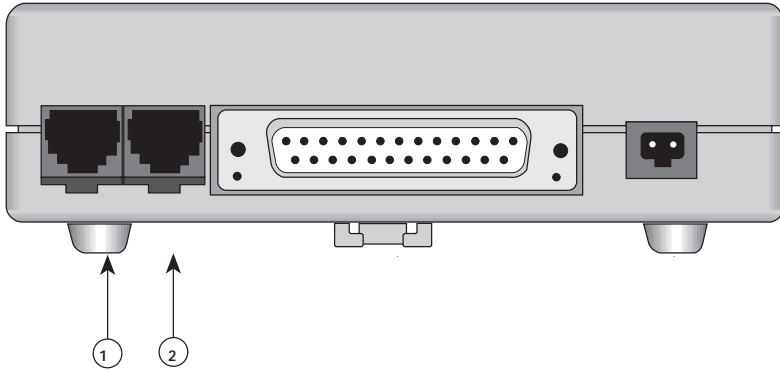

- 1: switched line and 2 wire leased line
- 2: 2/4 wire leased line with optional dial backup board

Appendix B3
Telephone Access Jacks
LGM 28.8D1

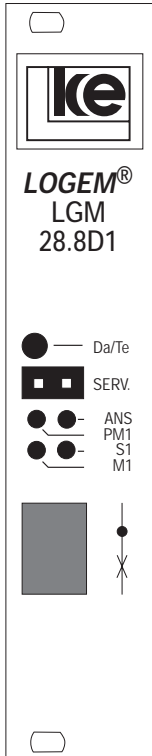

FKS8 Jack

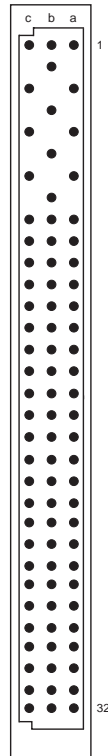

VG Connector

For switched line operation and 2/4 wire leased line with dial backup the FKS8 jack is connected in parallel to the related pins of the VG connector.

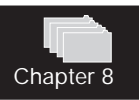

Appendix B4
Telephone Access Jacks
LGH 28.8D1



Appendix B3
Telephone Access Cable RJ12/TAE 6N

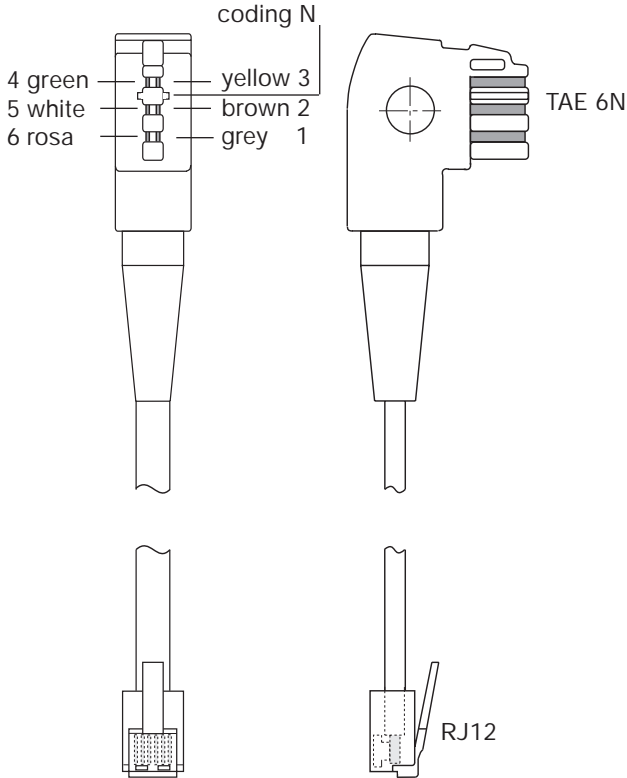

Chapter 8

allocation of the switched line cable				allocation of the leased line cable			
TAE	colour	descr.	RJ12	TAE	colour	descr.	RJ12
1	grey	La	5	1	grey	Tx(a) (2 wr.)	5
2	brown	Lb	2	2	brown	Tx(b) (2 wr.)	2
3	yellow	G	4	3	yellow	Rx a	4
4	green	E	3	4	green	Rx b	3
5	white	b2	1	5	white	idle	1
6	rosa	a2	6	6	rosa	idle	6
shield			S				

Appendix B4

Telephone Access Cable FKS8/TAE 6N

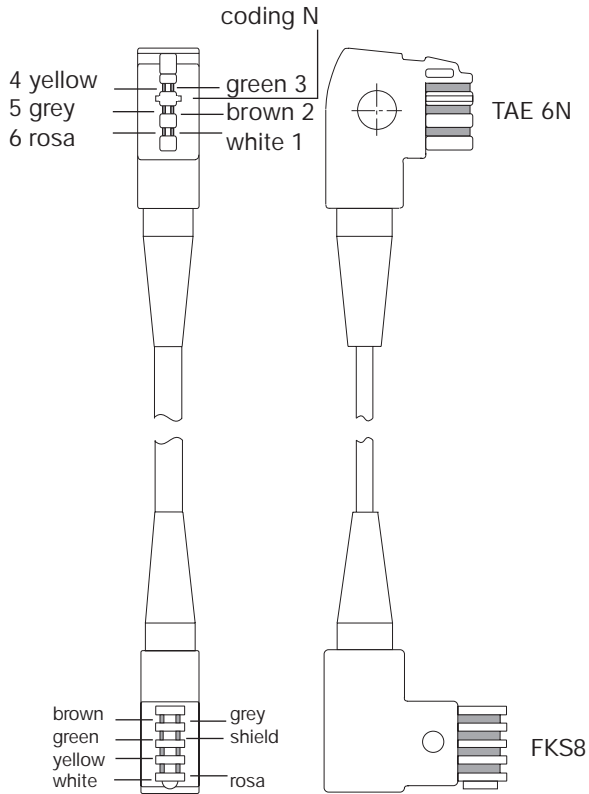

connector allocation		
1	white	La
2	brown	Lb
3	green	G
4	yellow	E
5	grey	b2
6	rosa	a2
	shield	S

Appendix C1
Data Interface LGM 28.8D1

DIN	ITU-T	int. name	description	pin
E2	102	GND	ground	16c
D1	103	TXD	transmit data	11c
D2	104	RXD	receive data	12c
S2	105	RTS	ready to send	13c
M2	106	CTS	clear to send	14c
M1	107	DSR	data set ready	15c
S1	108	DTR	data terminal ready = S1.1 or DTE operational = S1.2	16a
M5	109	DCD	data carrier detect	18c
M3	125	RI	incoming call	19a
PM1	142	TM	test status	22a
T2	114	TXC	transmit clock from DCE	11a
T4	115	RXC	receive clock from DCE	13a
T1	113	TXC	transmit clock from DTE	24a
S4	111		activate high transmission rate (DTE)	20a
M4	112		high transmission rate ON (DCE)	22c
PS2	140	RL	remote test loop	18a
PS3	141	LL	local test loop	14a

Voltage levels at the V.24 interface:

TTL (latch up protected HCMOS technology with integrated pull up resistors acc. to CEPT T/CD 1-14)

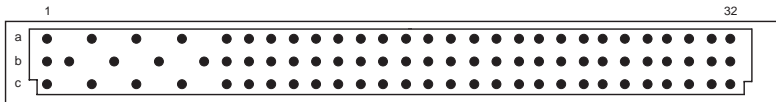

Appendix C2

Interfaces LGM 28.8D1

PIN	a	b	c
1	GND	GND	GND
2		G *	
3	Lb *		La *
4		Tx a (2-w.)	
5	Rx a		Rx b
6		Tx b (2-w.)	
7	b2 *		a2 *
8		E *	
9		ext. call generator	
10	HD1	S1/1 (SET1)	
11	T2	S1/2 (SET2)	D1
12	HD2	S1/3 (SET3)	D2
13	T4	S1/4 (SET4)	S2
14	PS3	S1/5 (SET5)	M2
15		S1/6 (SET6)	M1
16	S1	S1/7 (SET7)	GND
17		$\overline{\text{DTX}}$ (ext. data button)	
18	PS2	S1/8 (SET8)	M5
19	M3	S1/9 (SET9)	
20	S4	S1/10 (SET10)	
21	T1	S2/1 (SET11)	
22	PM1	S2/2 (SET12)	M4
23		S2/3 (SET13)	
24		S2/4 (SET14)	
25		VF- signal for amplifier	
26			
27			
28			
29	+5V	+5V	+5V
30	+5V	+5V	+5V
31	GND	GND	GND
32	GND	GND	GND

* These pins are connected to the FKS8 jack as well. The table presents the delivery state. Possible allocations are presented in chapter 6.

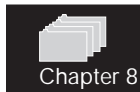

Appendix C3

V.24 Interface Allocations

DIN name	ITU-T name	Pin No. ISO-2110- Verbinder	Direction DTE-Modem	Name	Description
E1	101	1		GND	prot. ground
E2	102	7		GND	ground
D1	103	2	⇒	TXD	transmit data
D2	104	3	⇐	RXD	receive data
S2	105	4	⇒	RTS	request to send
M2	106	5	⇐	CTS	clear to send
M1	107	6	⇐	DSR	data set ready
S1.1	108/1	20	⇒	DTR	data terminal ready
S1.2	108/2	20	⇒	DTR	DTE ready
M5	109	8	⇐	DCD	data carrier detect
T2	114	15	⇐	TXC	transmit clock
T4	115	17	⇐	RXC	receive clock
M3	125	22	⇐	RI	ring indicator
PS3	141	18	⇒	LL	local loop
PM1	142	25	⇐	TM	test state
S4	111	23	⇒		set high transmission rate
M4	112	12	⇐	SPD	high transam. speed
PS2	140	21	⇒	RL	remote loop
T1	113	24	⇒	TXC	transmit clock
		9	⇐	+8 V	positive aux. voltage
		10	⇐	-8 V	negative aux.voltage

Attention! The auxiliary voltages allow for a max. charge of 25 mA.
The outputs are not resistant against short voltages!

Appendix C4 Asynchronous Standard Connection

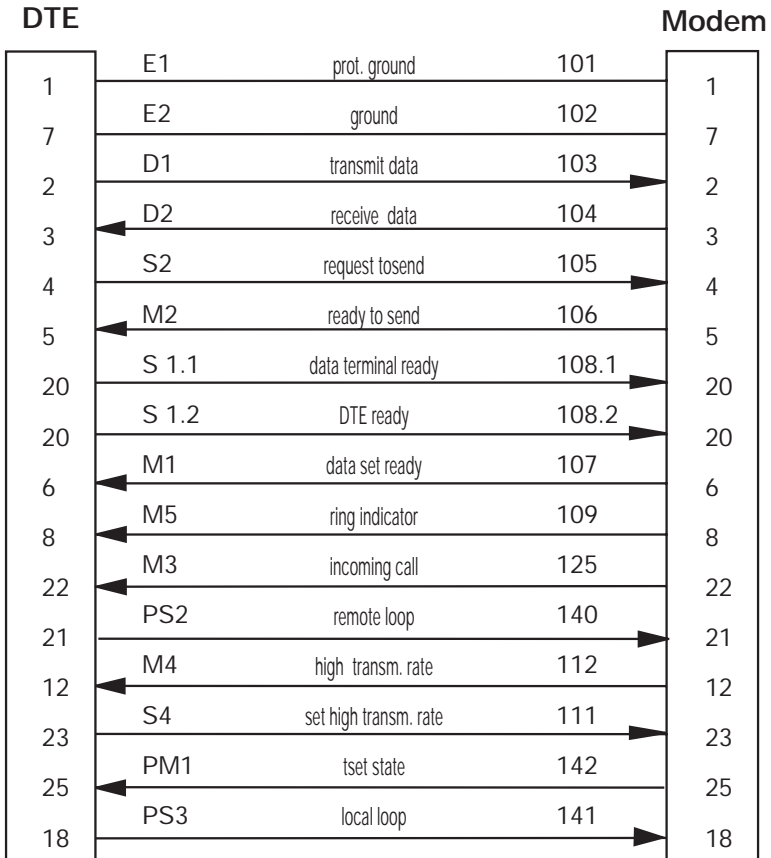

Appendix C5
Synchronous Standard Connection

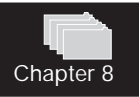
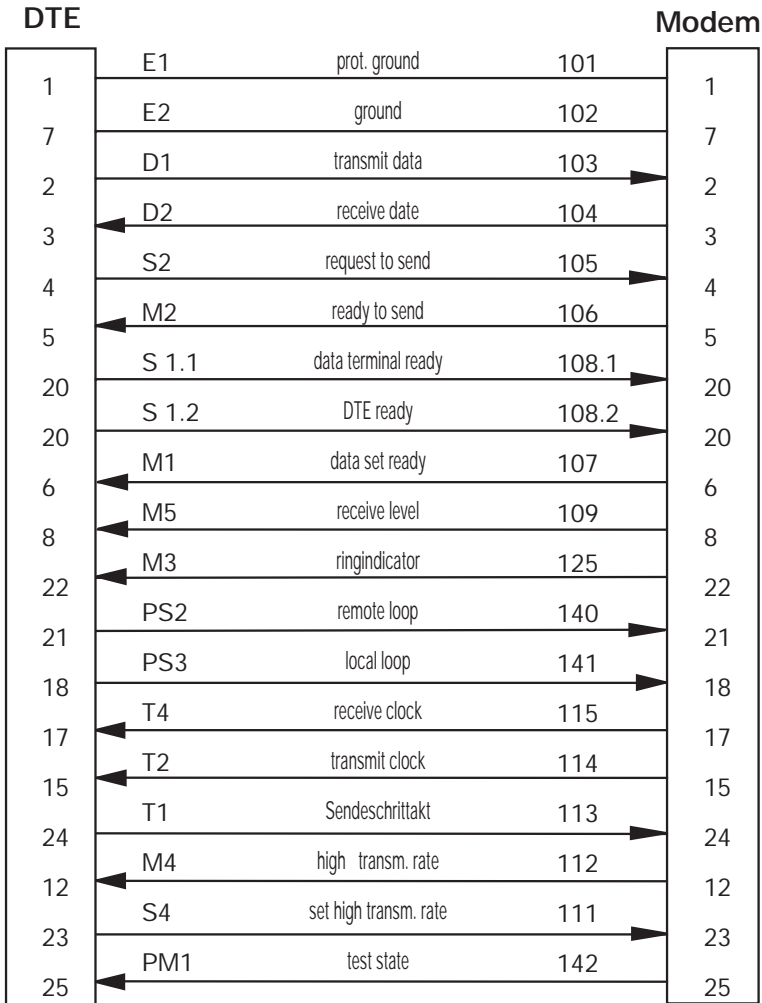

Appendix C6
Allocation of the 25pole Sub D Jack

The LOGEM 928 and the LGH 28.8D1 feature a 25pole sub D jack (acc. to ISO 2110) for DTE connection. A V.24 interface cable is part of the delivered items.

The signal, report and data lines come with V.28 levels.

25pole Sub D Jack:

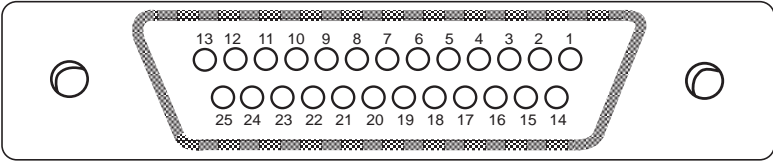

Appendix C7
Modem to Modem Cross Cable (asynchronous)

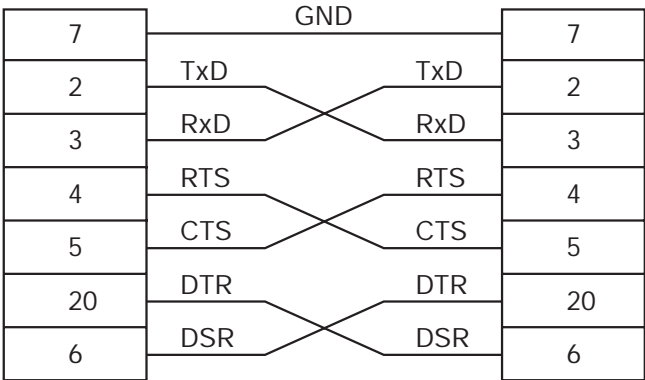

Appendix C8 Modem Identification

Identification of the modem specification (board, software version etc.) is possible from the modem sticker or with a software command.

1. Modem Sticker

377 XXX XX	/ article number
9308	/ production year/week
25	/ serial number
K.XX	/ configuration state

The so called K number (for configuration state) indicates the modem specification. The K number is being augmented after any alterations concerning software or hardware.

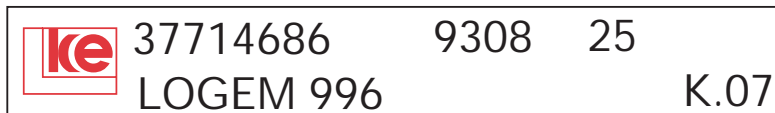

2. Software Mode (AT Commands)

After typing the command ATIO the modem issues the report listed below:

```
Version 3.03      20.06.96
Dok.Nr.:0106.01/0114.01
```

Here the modem comes with the software version 3.03. Please have your K number or software version number ready at any technical requests. The K sticker is updated to the most recent version at any manufacturer software updates (which is only possible by changing the EEPROM).

Appendix D

ASCII Table

Code	Mnem	DecHex	Code	DecHex	Code	DecHex	Code	DecHex
	NULL	00 00	SP	32 20	@	64 40	`	96 60
CTRL A	SOH	01 01	!	33 21	A	65 41	a	97 61
CTRL B	STX	02 02	"	34 22	B	66 42	b	98 62
CTRL C	ETX	03 03	#	35 23	C	67 43	c	99 63
CTRL D	EOT	04 04	\$	36 24	D	68 44	d	100 64
CTRL E	ENQ	05 05	%	37 25	E	69 45	e	101 65
CTRL F	ACK	06 06	&	38 26	F	70 46	f	102 66
CTRL G	BEL	07 07	'	39 27	G	71 47	g	103 67
CTRL H	BS	08 08	(40 28	H	72 48	h	104 68
CTRL I	HT	09 09)	41 29	I	73 49	i	105 69
CTRL J	LF	10 0A	*	42 2A	J	74 4A	j	106 6A
CTRL K	VT	11 0B	+	43 2B	K	75 4B	k	107 6B
CTRL L	FF	12 0C	,	44 2C	L	76 4C	l	108 6C
CTRL M	CR	13 0D	-	45 2D	M	77 4D	m	109 6D
CTRL N	SO	14 0E	.	46 2E	N	78 4E	n	110 6E
CTRL O	SI	15 0F	/	47 2F	O	79 4F	o	111 6F
CTRL P	DLE	16 10	0	48 30	P	80 50	p	112 70
CTRL Q	DC1	17 11	1	49 31	Q	81 51	q	113 71
CTRL R	DC2	18 12	2	50 32	R	82 52	r	114 72
CTRL S	DC3	19 13	3	51 33	S	83 53	s	115 73
CTRL T	DC4	20 14	4	52 34	T	84 54	t	116 74
CTRL U	NAK	21 15	5	53 35	U	85 55	u	117 75
CTRL V	SYN	22 16	6	54 36	V	86 56	v	118 76
CTRL W	ETB	23 17	7	55 37	W	87 57	w	119 77
CTRL X	CAN	24 18	8	56 38	X	88 58	x	120 78
CTRL Y	EM	25 19	9	57 39	Y	89 59	y	121 79
CTRL Z	SUB	26 1A	:	58 3A	Z	90 5A	z	122 7A
	ESC	27 1B	;	59 3B	[91 5B	{	123 7B
	FS	28 1C	<	60 3C	\	92 5C		124 7C
	GS	29 1D	=	61 3D]	93 5D	}	125 7D
	RS	30 1E	>	62 3E	^	94 5E	~	126 7E
	US	31 1F	?	63 3F	_	95 5F	DEL	127 7F

Appendix E
Glossary

DBU	Dial Backup Unit
DTE	Data Terminal Equipment
Dial Backup	Dial backup (switching of a secondary path via switched lines) is activated whenever the leased line is broken. The modem establishes automatically a switched line connection to the remote station. If the leased line is operational again the modem switches back automatically.
DCE	Data Communication Equipment
RAM	Random Access Memory. Part of the memory that can be read out and rewritten. The modem stores its current configuration in this part of the memory. After a failure of the operating voltage the memory content is lost.
ROM	Read Only Memory. The factory defaults are stored in the ROM where they are available permanently.
EEPROM	Electrically Erasable Programmable Read Only Memory. User configuration and phone numbers are stored here with a specific command.
 Chapter 8 direct call	The direct call option allows for dialing a phone number (stored with AT&Z0) from the number directory without a dial command just by setting the interface line S1/DTR.
direct mode	Direct mode allows for transparent data transmission. The transmission rate between modem and the DTE corresponds to the transmission rate between the modems. DTE data is transferred directly to the modulator of the modem, i.e. data is transferred without a data buffer. Data flow control between modem and DTE is not necessary here. A connection has to be deestablished by deactivation of S1/DTR as the escape sequence (+++) is not recognized here.

normal mode	The modem buffers data coming from the DTE. For this reason the transmission rate DTE/modem may differ from the modem to modem transmission rate. To prevent data losses the data flow control has to be activated. The modem processor controls the data transfer from the modem buffer. During normal mode data transmission is performed without data protection protocols.
reliable mode	Corresponds to normal mode. As an addition data protection protocols (MNP4, V.42) are active. The establishment of a connection is terminated if the modem operates in reliable mode and the remote modem does not support any data protection protocols.
autoreliable mode	Data transmission is possible with or without data protection.
speed buffering	Speed buffering guarantees for constant interface rates towards the terminal equipment if multimode modems are employed that support different modulations.
data flow control	Data flow control is implemented to avoid data loss during transmission. Data loss may occur whenever the data buffer of the modem overflows. The modem has to prevent in such cases the terminal equipment from transmitting further data. Data flow control is possible as: <ol style="list-style-type: none">hardware flow control; the signals S2 and M2 (RTS and CTS) of the V.24 interface are employed for flow control.software flow control; the XON and XOFF characters are employed for flow control; the connection is not transparent.
data protection protocol	The data protection protocol is employed to correct transmission errors. The modems come with implemented protection protocols. For this reason the terminal equipment transmits and receives only effective data. At an active data protection protocol transmit data is formed to blocks and transmitted with a checksum. The receive side computes the

checksum for each received block and compares it with the received checksum. A block is being positively acknowledged if no errors occur. A retransmission of the block is requested if any errors occur.

data compression Due to the data compression the data of the transmitting modem is compressed with special algorithms and transmitted. The receiving modem decompresses these data and transfers it to the terminal equipment. Data compression is only applicable with activated data protection protocols.

MNP 1...4 Data Protection Protocols.

MNP 5 Data Compression Procedure.

V.42 Data Protection Protocol.

V.42bis Data Compression Procedure.



Appendix F

Technical Data

	standalone LOGEM 928	rackmounted LOGEM LGM 28.8D1	top rail LOGEM LGH 28.8D1
dimensions (h x w x d) in mm	40 x 114 x 180	130 x 26 x 190	135 x 43 x 124
environmental conditions at operation/storage			
temperature	0...40 °C / -25 ... +55 °C		
rel. humidity	85 % / < 98 %		
climatic model acc. to DIN 50019 (non condensing)	R 12 / R 52		
power supply			
	power supply adapter inp. 230V/50HZ/7VA outp. 7V/50Hz/4.2VA	+5 V ± 5 % ca. 300 mA	+ 24 V ± 20 % max. 100 mA
electrical values for line switching			
return loss attenuation/ symmetrie	> 14 dB / > 55dB (at 300 ... 3400 Hz, against Z)		
voltage resistance betw. VF side and V.24 interf.	2 kV		
DC resistance	ca. 300 Ω		
loop current	11 - 60 mA		
DTE interface			
mechanical	25pole sub D jack acc. to ISO 2110	96pole connector, DIN 41612, partially equipped, type R, class 2	25pole sub D jack ISO 2110
electrical	acc. to ITU-T V.28	CMOS / TTL levels	ITU-T V.28
bit/s	asynchronous 300 ... 115200 synchronous 600 ... 64000		



AppendixG

Index

Symbols

2 wire leased line	153
2/4 wire leased line	18
25pole sub D jack	185
4 wire leased line	156

A

applications	145
ASCII table	187
asynchronous operation	76
AT command set	17, 67
automatic dialing	17, 70
autoreliable fallback character	91
autoreliable mode	189–190

B

Backpanel LOGEM ® 928	20
backspace character	109
backup number	18
basic setting 0	171
basic setting	34
basic setting 1	172
basic setting 8	173
baud rate detection	67
BLACKLISTED	76
block mode 8	9
Board of the LGH 28.8D1	63
Board of the LGM 28.8D1	61
Board of the LOGEM ® 928	59
BREAK	93
BREAK signal	101, 149

C

callback	15–16
carriage return	108
citycall message	29
command description	68

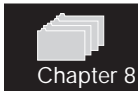

command interpreter	68, 119
command line	67
compatibility	17
compatible mode	16, 34
CONNECT	80
Country Setting for LGH 28.8D1	64

D

Da/Te button	114
data compression	15-16, 17, 92, 190
data flow control	93, 189-190
data format	115
data interface LGM 28.8D1	180
data protection	17
data protection protocols	15-16, 145-150
DBU	188-190
DBU board	137
DCE	188-190
DELAYED CALL	76
Dial Abortion	71
dial backup	118, 188
dial backup board	75, 135
dial prefix	100
dial sequence	71
dial up	71
dialing mode	120
dialing process	71
DIP switches	15-16, 33
direct call	188-190
direct mode	188-190
DNL commands	15-16
DTE	188-190
duplex operation.....	95

E

echo character	121
ECM mode	121
EEPROM	29, 105
ERROR.....	code 73
error correction procedure	90
escape character	35, 108
escape sequence	69, 73
event report system	29

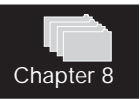

F

fax message	29
fax operation	18
fax software	18
FAX transmission rate	120
FKS8 jack	176
Front Panel LOGEM® LGM 28.8D1	21
Front Panel LOGEM® 928	19
Front Panel LOGEM® LGH 28.8D1	23

G

glossary	188
guard tone	74

H

halfduplex simulation	95
Hayes standard	67

I

index	193
installation and commissioning	26
ITU-T	15–16, 18

J

jumpers	138
---------------	-----

L

leased line	157
leased line operation	151
LGM 1200H1 Operation	38
LGM 2400D2 Operation	40
lightning and overvoltage protection	167
line feed	108
line interface	15–16
line selection	75
LOGEM® 914/LGM 14.4D1	
Synchronous/V.25bis	44
LOGEM® 928	15



LOGEM ® 928/LGM 28.8D1 Asynchronous	50
LOGEM ® 928/LGM 28.8D1 Synchronous V.25bis	48
LOGEM ® LGH 28.8D1	15
loudness	101
loudspeaker setting	101

M

manual dial backup	158
mixed mode	16, 34
Mixed Mode Switches	43
MNP 1...4	190
MNP 5	190
MNP block length	89
MNP4	145–150
modem cross cable	185
modem description	15
modem identification	73, 186
modem message	29
modem settings	86

N

normal mode	189–190
number of rings	108

O

operation mode labeling	98
operation modes	15, 34

P

PABX	70
password	18, 145
password protection	18, 96
POWER ON	34
pulse dialing	74

R

rackmounted version	15, 27
RAM	29, 105
register allocation	105



register description	107
reliable mode	100–101, 189–190
remote access	111
remote configuration	15,16, 18, 100, 145ff.
result codes	79
retrain	94
ROM	105

S

safety instructions	9
secondary path	135
short dial register	130
Side View LOGEM® LGM 28.8D1	22
software mode	16, 34, 52
special modem version	21
speed buffering	189–190
standalone modem	15
standalone version	26
stream link mode	89
super password	96
switched line	18, 157
switches description	33
switches tables	33
synchronous standard connection	184

T

TAE 6NF socket	174
technical data	191
telephone access cable FKS8/TAE 6N	179
telephone access cable RJ12/TAE 6N	178
telephone access jacks	175
test loops	77
tone dialing	74
top rail installation	15
top rail version	28
Top Side LOGEM® LGH 28.8D1	24
transmission procedure	72
transmission procedures	16
Transmit and Receive Levels	58
transparent mode	73



U

user setting 35, 84–87

V

V.24 interface allocations 182
V.25bis commands 17, 125
V.42 145–150, 190
V.42bis 190
verbose result codes 79

X

XOFF character 111
XON character 111
XON/XOFF character 94





