

Catalog Number: 40437-025

Features and Ratings

- Ringless Type Meter Socket
- 200A Continuous, 200A Max., 600V AC
- Outdoor Enclosure (NEMA Type 3R)
- Painted Steel Enclosure
- 3 Phase, 4 Wire
- 7 Jaw Meter Socket
- Meter Socket Type HQ-7U
- For Overhead & Underground Service
- 2-1/2" RX Type Hub Installed
- Lever Bypass

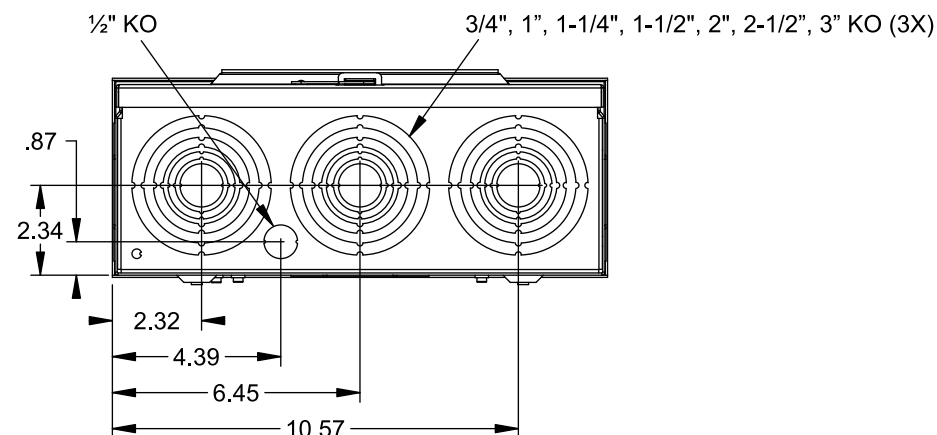
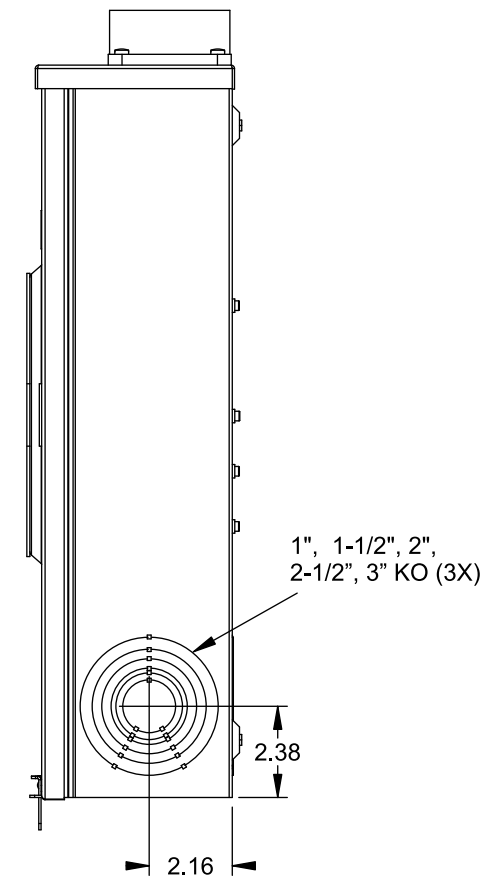
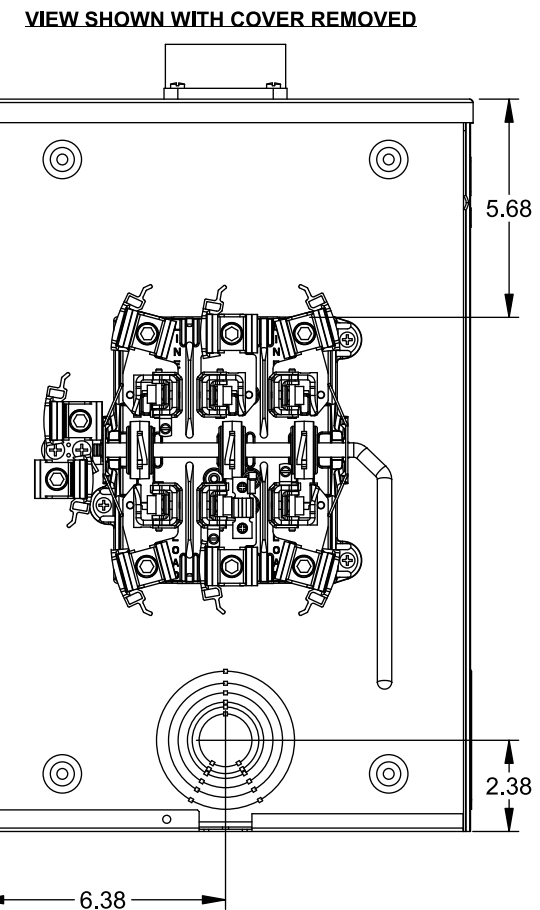
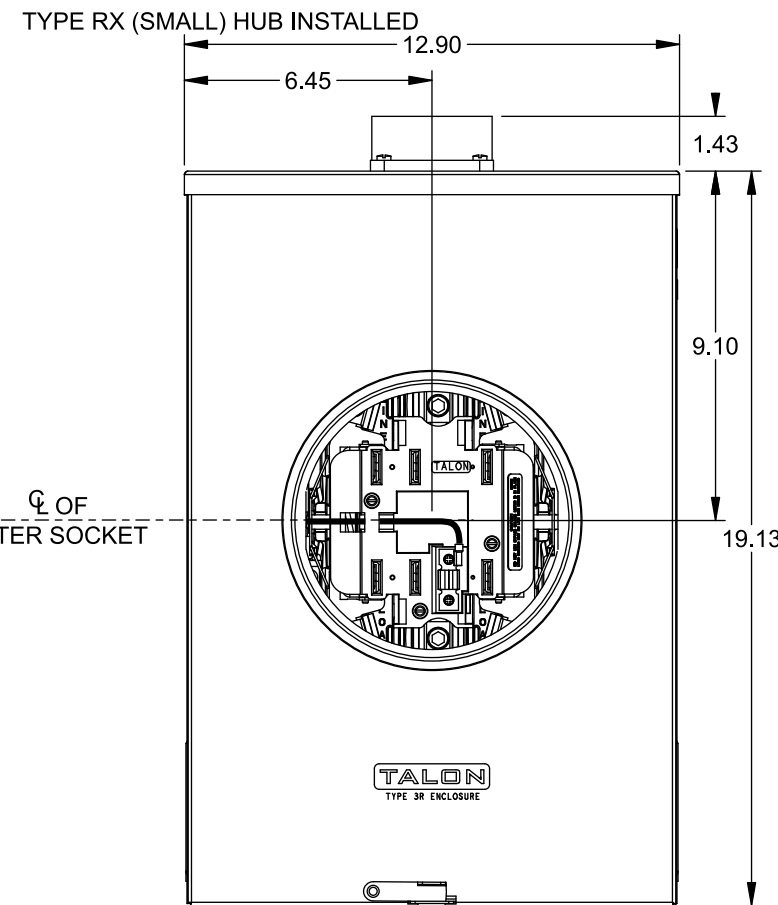
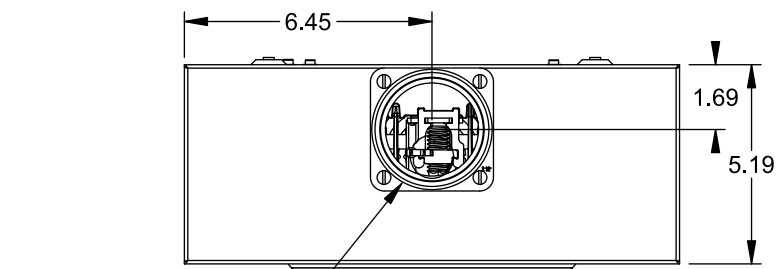
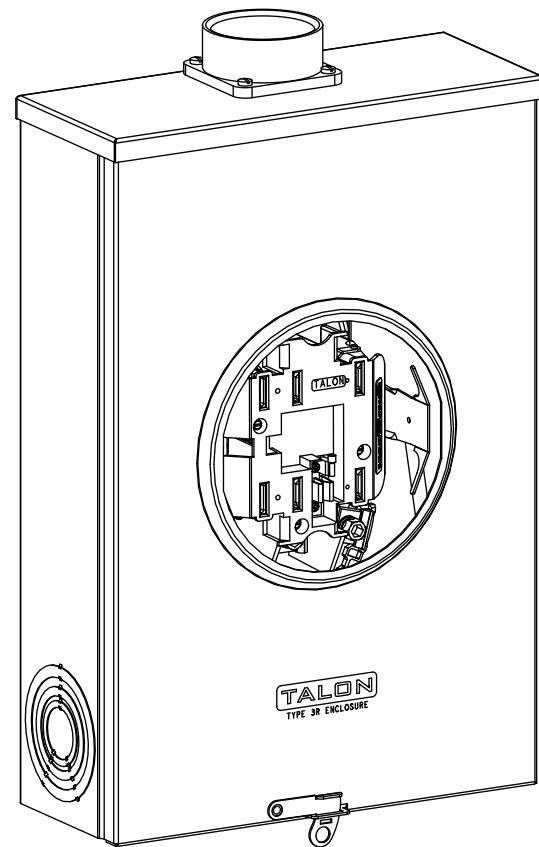

Accessories

CONDUIT HUBS (RX Type)	
TRADE SIZE	CATALOG No.
1-1/4 INCH	EC38597 or H38597-2
1-1/2 INCH	EC38598 or H38598-2
2 INCH	EC38599 or H38599-2
2-1/2 INCH	EC38600 or H38600-2

Hub Cover Plate EC38595 or H38595-1

Meter Opening Cover Plate
Cat No: H659-0162

Connectors, Wire Sizes and Torques

CONNECTOR	WIRE SIZE	TORQUE
LINE, LOAD, NEUTRAL*	#6 - 350 kcmil	275 IN.-LBS.
GROUND	#14 - 2 AWG	45 IN.-LBS.

* External Hex Drive 1/2"
* Internal Hex Drive 5/16"

© 2015 Copyright Siemens Industry, Inc.

TALON
Meter Socket

Description: **200A Cont, 7 Jaw, HQ-7U, 600V AC, Painted Steel Enclosure**

JEL 8/30/15 DO NOT SCALE DRAWING Dwg No: **40437-025**