

SIEMENS

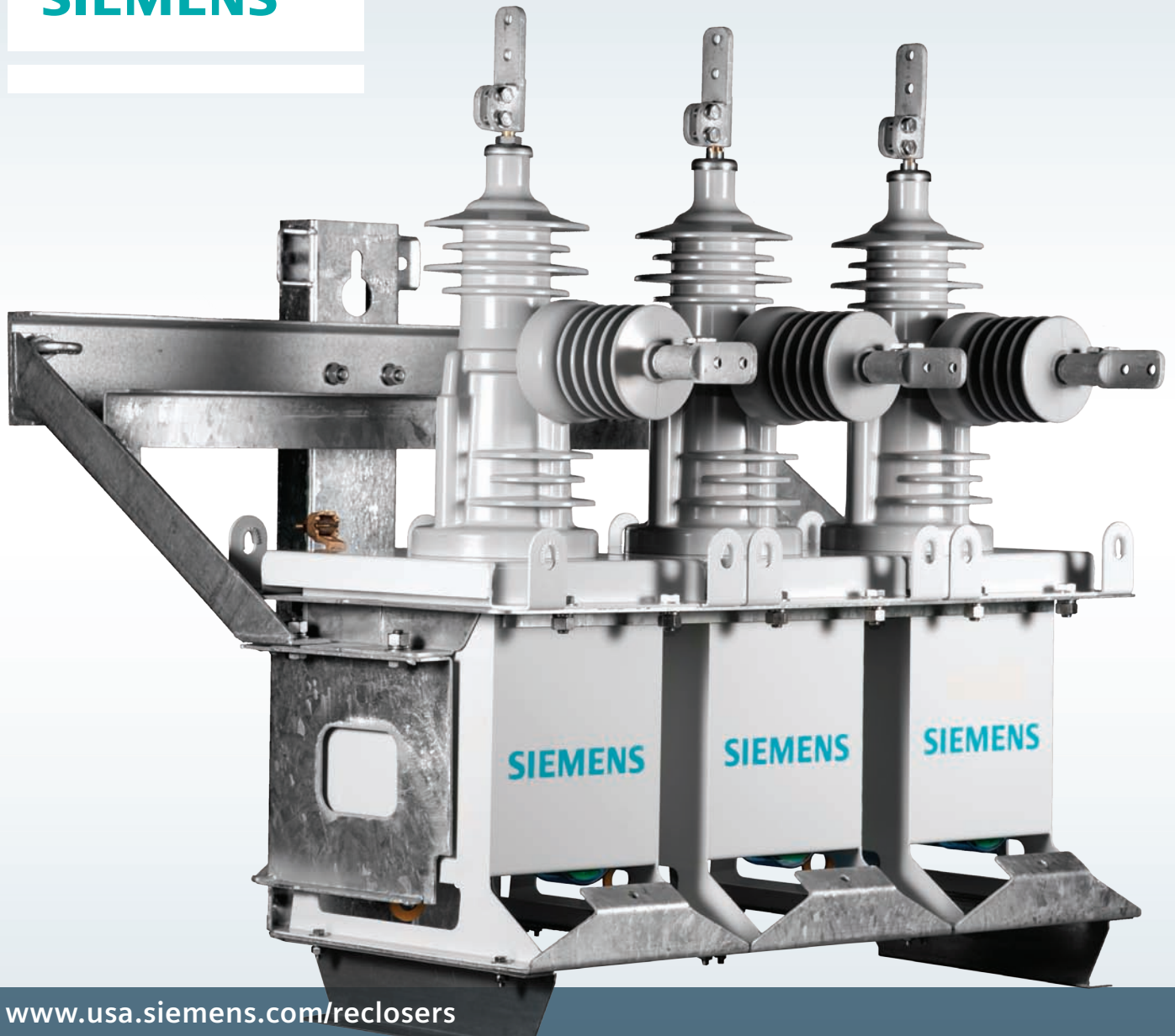

www.usa.siemens.com/reclosers

Instruction manual

Type SDR 15.5 kV to 27 kV triple-single distribution recloser

Installation operation maintenance E50001-F710-A412-X-4A00

Answers for infrastructure.

	⚠ DANGER
	<p>Hazardous voltages.</p> <p>Will cause death, serious injury or property damage.</p> <p>Always de-energize and ground the equipment before maintenance. Read and understand this instruction manual before using equipment. Maintenance should be performed only by qualified personnel. The use of unauthorized parts in the repair of the equipment or tampering by unqualified personnel will result in dangerous conditions which will cause death, severe injury or equipment damage. Follow all safety instructions contained herein.</p>

Important

The information contained herein is general in nature and not intended for specific application purposes. It does not relieve the user of responsibility to use sound practices in application, installation, operation and maintenance of the equipment purchased. Siemens reserves the right to make changes in the specifications shown herein or to make improvements at any time without notice or obligation. Should a conflict arise between the general information contained in this publication and the contents of drawings or supplementary material or both, the latter shall take precedence.

Qualified person

For the purpose of this manual a **qualified person** is one who is familiar with the installation, construction or operation of the equipment and the hazards involved. In addition, this person has the following qualifications:

- **Is trained and authorized** to de-energize, clear, ground and tag circuits and equipment in accordance with established safety procedures.
- **Is trained** in the proper care and use of protective equipment, such as: rubber gloves, hard hat, safety glasses or face shields, flash clothing, etc., in accordance with established safety practices.
- **Is trained** in rendering first aid.

Further, a qualified person shall also be familiar with the proper use of special precautionary techniques, personal protective equipment, insulation and shielding materials, and insulated tools and test equipment. Such persons are permitted to work within limited approach of exposed live parts operative at 50 volts or more, and shall, at a minimum, be additionally trained in all of the following:

- The skills and techniques necessary to distinguish exposed energized parts from other parts of electric equipment
- The skills and techniques necessary to determine the nominal voltage of exposed live parts
- The approach distances specified in NFPA 70E and the corresponding voltages to which the qualified person will be exposed
- The decision-making process necessary to determine the degree and extent of the hazard and the personal protective equipment and job planning necessary to perform the task safely.

Note:

These instructions do not purport to cover all details or variations in equipment, nor to provide for every possible contingency to be met in connection with installation, operation or maintenance. Should further information be desired or should particular problems arise that are not covered sufficiently for the purchaser's purposes, the matter should be referred to the local sales office.

The contents of this instruction manual shall not become part of or modify any prior or existing agreement, commitment or relationship. The sales contract contains the entire obligation of Siemens Industry, Inc. The warranty contained in the contract between the parties is the sole warranty of Siemens Industry, Inc. Any statements contained herein do not create new warranties or modify the existing warranty.

Table of contents

Introduction	04 – 05
General description	06 – 14
Receiving, handling and storage	15 – 16
Installation and commissioning	17 – 21
Operation	22 – 24
Maintenance	25 – 26
Technical data	27 – 31
Installation and commissioning report	32 – 37
Annex A	38 – 39

Introduction

Introduction

These instructions apply to the triple-single distribution vacuum recloser type SDR and are intended to familiarize personnel with the mechanical design and function of the recloser. These instructions also include notes on operation and information concerning installation and maintenance.

The purpose of this manual is to assist the user in developing safe and efficient procedures for the installation, maintenance and use of the equipment.

Personnel must familiarize themselves as early as possible with the instructions and other documents provided in order to gather any further relevant information on the recloser and its features.

Should further information be desired, or should particular problems arise that are not covered in the operating instructions, the matter should be referred to the local Siemens sales office.

In written or verbal communications, please provide the serial number of the recloser, the complete description from the operating instructions, and use only the designations and numbers for sub-parts used in this instruction manual.

Designated use

The recloser is deemed properly used when it is operated in accordance with the agreed terms and conditions of supply and technical data and also the equipment and special tools supplied are used exclusively for their intended purpose in accordance with the provisions of these operating instructions and applicable laws, codes, regulations and standards.

Any other use is forbidden, unless the consent of Siemens has been obtained.

If the above-mentioned conditions are not observed or the safety instructions are not followed, there can be danger from:



- High voltage
- Charged springs
- Falling and/or tipping parts
- Charged capacitors.

Responsibility of the operator

In order to avoid incidents, mis-operation or equipment damage, the party responsible for transportation, installation, operation, maintenance and disposal of the recloser or of parts thereof must ensure that only qualified and instructed personnel are assigned to work. Before starting work, regularly thereafter and following any unusual occurrences, personnel shall be instructed concerning the possible hazards and the safety measures required.

Regulations and instructions for safety at work (together with instructions on action to be taken in the event of incidents and/or fire) shall be available to personnel.

Equipment and facilities required for safe work and also the personal protective equipment, clothing, etc., necessary for certain procedures shall be available and used. Only spare parts, lubricants and auxiliary materials approved by Siemens shall be used.

	 DANGER
	<p>Hazardous voltages.</p> <p>Will cause death, serious injury and property damage.</p> <p>Do not contact energized conductors.</p> <p>De-energize and ground high voltage conductors before working on or near them.</p>

Signal words

The signal words “danger,” “warning” and “caution” used in this manual indicate the degree of hazard that may be encountered by the user. These words are defined as:

Danger - Indicates an imminently hazardous situation that, if not avoided, **will** result in death or serious injury.

Warning - Indicates a potentially hazardous situation that, if not avoided, **could** result in death or serious injury.

Caution - Indicates a potentially hazardous situation that, if not avoided, **may** result in minor or moderate injury.

Notice - Indicates a potentially hazardous situation that, if not avoided, **may** result in property damage.

Hazardous procedures

In addition to other procedures described in this manual as dangerous, user personnel must adhere to the following:

1. Always work only on de-energized equipment. Always de-energize the equipment before performing any tests, maintenance or repair. The equipment should be isolated, grounded and have all control power removed before performing any tests, maintenance or repair.
2. Always perform maintenance on the control cabinet only after the capacitors are discharged (see page 13).
3. Check to be certain the indicator flag is green, indicating that the switch unit is in the open position (see Figure 7).
4. Always let an interlock device or safety mechanism perform its function without forcing or defeating the device.

Field service operation and warranty issues

Siemens can provide competent, well-trained field service representatives to provide technical guidance and advisory assistance for the installation, overhaul, repair and maintenance of Siemens equipment, processes and systems. Contact regional service centers, sales offices or the factory for details, or telephone Siemens field service at +1 (800) 347-6659 or +1 (919) 365-2200 outside the U.S.

For medium voltage customer service issues, contact Siemens at +1 (800) 347-6659 or +1 (919) 365-2200 outside the U.S.

General description

Recloser principle and design

Reclosers are used in distribution systems. Like circuit breakers, reclosers are used to make and break normal and fault currents. Reclosers are fully equipped with sensors and a controller to provide a means of protection and control. In case of a line fault, reclosers can break and make currents several times, thus avoiding longer network interruptions due to temporary faults.

Type SDR vacuum reclosers are outdoor devices designed for repeated opening and reclosing in case of a fault, as specified in ANSI/IEEE standard C37.60.

The vacuum recloser consists of two main components: the recloser switch and the controller. The triple-single type SDR vacuum recloser consists of three single-phase switch units, each mounted in a separate tank and controlled from a common controller.

This instruction manual covers information related to the recloser switch units and the controller. The instruction manual does not cover the switch units mounting frame, control and protection relay or related accessories (for example, surge arresters, external voltage sensors, modems or radios).

For information pertinent to the mounting frame for the switch units, refer to the frame installation drawing provided with the order specific drawings.

For information pertinent to the control and protection relay, refer to the manufacturer's instruction manuals.

The manufacture, design and testing of the vacuum recloser is based on current regulations and standards and state-of-the-art technology. The product conforms to the following standards:

- ANSI/IEEE C37.60/IEC 62271-111
- IEC 60255-11
- IEC 60255-21-1 Class I
- IEC 60255-21-2 Class I
- IEC 60255-21-3 Class I
- IEC 60255-22-1 Class III
- IEC 60255-22-2 Class IV
- IEC 60255-22-3 Class III
- IEC 60255-22-4 Class IV
- IEC 60255-22-5
- IEC 60255-22-6
- IEC 60255-25
- IEC 60255-5
- IEC 62271-1

Note: IEEE C37.60 and IEC 62271-111 are the same document (dual logo IEEE and IEC).

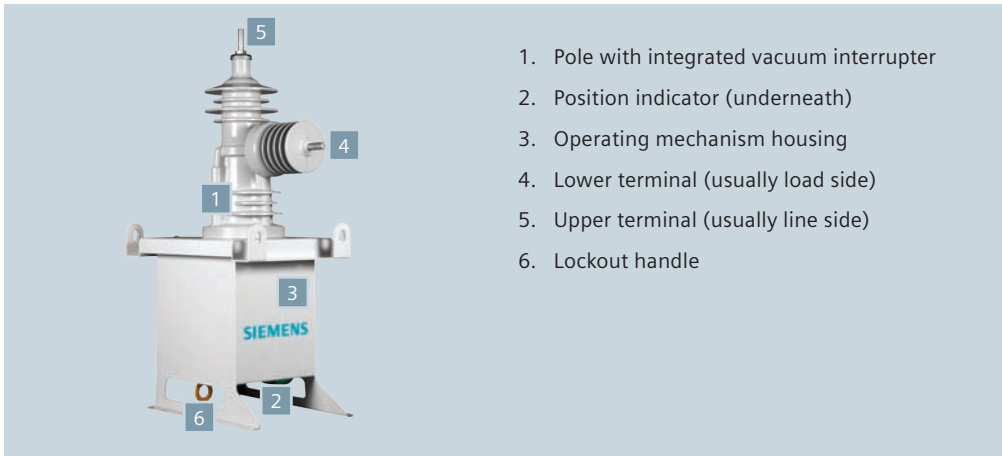

1. Pole with integrated vacuum interrupter
2. Position indicator (underneath)
3. Operating mechanism housing
4. Lower terminal (usually load side)
5. Upper terminal (usually line side)
6. Lockout handle

Figure 1: Single-phase recloser switch unit (front view)

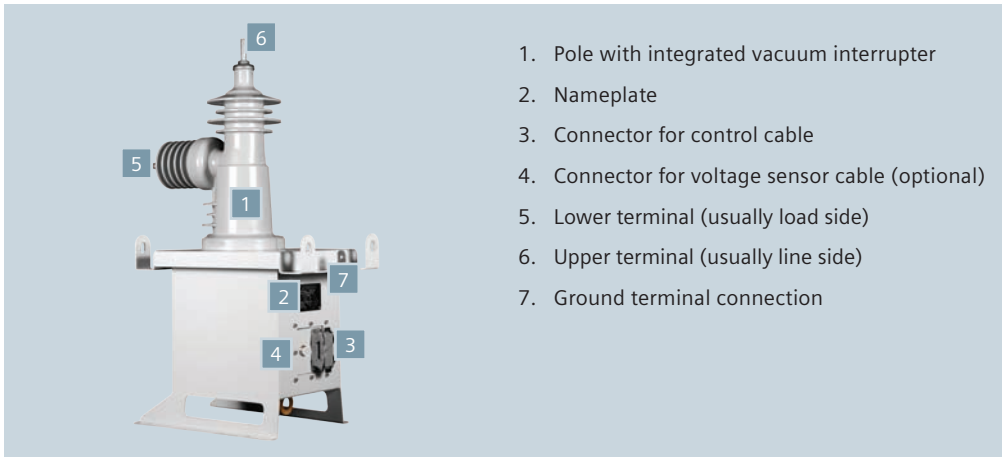

1. Pole with integrated vacuum interrupter
2. Nameplate
3. Connector for control cable
4. Connector for voltage sensor cable (optional)
5. Lower terminal (usually load side)
6. Upper terminal (usually line side)
7. Ground terminal connection

Figure 2: Single-phase recloser switch unit (rear view)

Triple-single recloser switch unit with encapsulated vacuum interrupter

The type SDR triple-single vacuum recloser consists of three single-phase switch units. The three switch units are typically close coupled in a common mounting frame (refer to Figure 3: Typical triple-single close-coupled pole mounting front view on page 8), but may be separately mounted, in close proximity, for applications such as cluster mountings, cross-arm mountings or vertical mountings on utility poles. Each triple-single recloser switch unit is comprised of the poles, the operating mechanism and the operating mechanism housing. The operating mechanism housing with the support feet form the base of the recloser switch unit. The switch units can be secured to the pole mounting or substation frame.

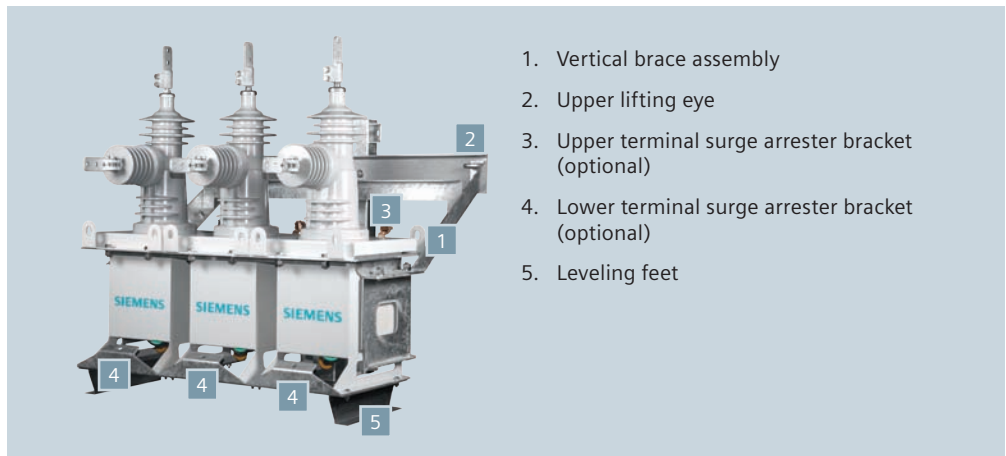

Figure 3: Typical triple-single close-coupled pole mounting front view



Figure 5: Pole with integrated vacuum interrupter

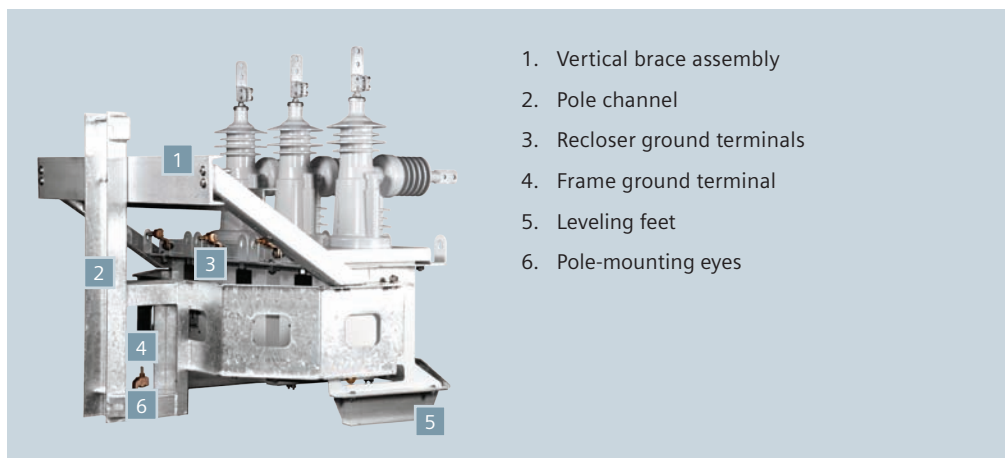

Figure 4: Typical triple-single close-coupled pole mounting rear view

Pole

The poles are molded using cycloaliphatic epoxy resin specially designed for outdoor use. The vacuum interrupters are encapsulated in the pole units. In addition, each pole contains a current transformer and may also contain an optional voltage sensor, both monitoring the lower terminal.

The phase designation and sequence of the poles is determined by the connection of the control cable and optional voltage sensing cables at the rear of each of the three recloser switch unit poles. These cables transition from a single connection at the type SDR triple-single controller to three separate connections at the switch unit poles.

The upper cable ends are marked to identify the phase designation (A, B or C). These cables may be aligned to match the system phase sequence during installation (refer to page 20). This sequence identifies the currents I_A , I_B and I_C of the controller. The phase sequence also may be changed to match the system phase sequence using the control and protection relay software.

Current transformers (CTs)

The type SDR vacuum recloser is equipped with one integrated current transformer per pole. The current transformer is the conventional type (iron core magnetic) and has a ratio of 800 A:1 A. It is for protection purposes and optimized for operation with the controller (see controller on page 11). The secondary signal is based on IEC 60044-1 and the IEC accuracy is 0.5 VA 5P20.

The secondary wires of the CT are connected to a varistor for each pole in the switch unit. This prevents the occurrence of high voltages (due to open-circuit CT secondary) if the control cable is removed while the switch unit is in operation. Do not disable the varistor circuit. The signal transfer from the CTs to the controller is by the control cable. A separate cable is not required.

Voltage sensor (optional)

The SDR vacuum recloser can be equipped with integrated resistive voltage sensors (optional). The integrated resistive voltage sensors have a high level of accuracy and are used both for measurement and protection purposes. The ratio is adapted to operation with the controller (see controller on page 11) and provides a $110 V/\sqrt{3}$ secondary signal with rated primary voltage applied to the recloser.

The voltage sensor and CT outputs are coordinated with Siemens controllers. If a non-Siemens controller is used, it is the controller vendor's obligation to properly coordinate their controller with the voltage sensors and CTs provided in the type SDR distribution vacuum recloser.

An optional separate sensor cable equipped with special screening (shield) is used for the signal transfer from the voltage sensors to the controller. This results in a high level of accuracy and protection against disturbances. The sensor cable is connected at the back of the operating mechanism housing next to the control cable.

The secondary wires of the voltage sensors are connected to a varistor for each pole in the switch unit. This prevents the occurrence of high voltage on the sensor cable if the sensor cable is removed while the switch unit is in operation. Do not disable the varistor circuit.

Operating mechanism

The operating mechanism for each of the three vacuum interrupters is located in a separate metal housing. To meet the required fast reclosing cycles, a magnetic actuator with capacitors as energy storage drives the switch units.

Each operating mechanism is equipped with an anti-condensation space heater. It is operated together with the heating in the controller and controlled by a thermostat.

A mechanical position indicator is easily visible from the ground and shows the current switch position of each recloser (open = green, closed = red). The colored display is reflective in the dark when using a flashlight.

Lockout handle

A lockout handle with ring protrudes from each of the three operating mechanism housings. The rings are colored bright yellow and are therefore easily seen.

By pulling any of the three lockout handles, the selected phase of the recloser opens and remains locked in this position. The locking has a dual electrical effect; it locks out both the controller and the electronics. It also mechanically locks the magnetic actuator for that phase.

As long as the lockout handle is pulled out, it is not possible to close the switch unit for that phase electrically, whether locally or from a remote location. The interlocking is not reset until the lockout handle has been completely pushed in. After this, the switch unit for that phase can be closed electrically, either locally or remotely.

The switching is described in the Operation section of this instruction manual (see page 22).

Note: Each lockout handle must be fully pushed in or the interlocking will prevent closing of the affected recloser.

Recloser position	Color of position indicator
Closed	Red
Open	Green

Table 1: Recloser position and indicator color



Figure 6: Single-phase operating mechanism (viewed from below)

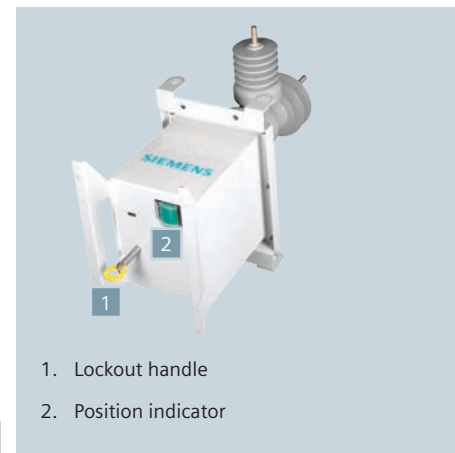
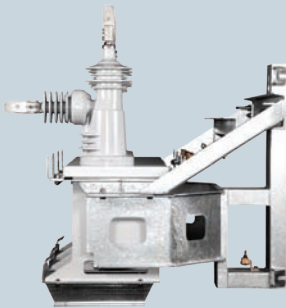

Figure 7: Single-phase operating mechanism with lockout handle pulled out (viewed from below)



1. Operations counter

Figure 8: Single-phase operations counter on the bottom of the switch unit



Triple-single frame



Single-phase frame

Figure 9: Typical pole-mounting frames

Operations counter

A mechanical operations counter is installed at the bottom of each recloser switch unit. It records the total number of switching operations independently of the electrical recording in the controller. The operations counter is used to keep track of the total number of operations of the switch unit in case the controller is replaced or the electronic counter is reset in the controller.

Mounting frames for recloser switch unit

A pole-mounting frame is used to install the recloser switch unit on an overhead line pole. The mounting frames can also optionally accommodate surge arresters, source-side external voltage sensors and control power transformers. The following pole-mounting frames are available:

- Triple-single pole frame (see Figure 9: Typical pole-mounting frames) with optional provisions for line-side external voltage sensors, line- and load-side surge arresters and control power transformers.
- The single-phase mounting frames may be used for cross-arm mountings or for cluster mountings or vertical mountings on utility poles.

For installation within a substation, a special mounting frame is available.

For pad-mounted applications, customized solutions are available.

Consult frame installation drawing provided with the order-specific drawings for information on mounting frames.

Control and protection relays

The term type “SDR controller” refers to the control cubicle as described by the type SDR distribution recloser. The option for control and protection relays are brand specific.

This instruction manual includes information on the type SDR controller to supplement information in the control and protection relay instruction manuals.

The user should consult information on the control and protection vendor’s web site for information on the specific relay involved (see Annex A on page 38).

The type SDR triple-single controller may be ordered with multiple control and protection relay options. The optional relays include:

- Siemens type 7SR224 recloser control relay (standard control and protection relay option)
- Schweitzer Engineering Laboratories, Inc. type SEL-651R recloser control relay (includes internal power module and capacitors which operate the switch unit magnetic actuators; type SDR switch unit driver electronics [PCB2] and capacitors [PCB3] are not utilized).

Only the Siemens type 7SR224 control and protection relay option is illustrated in this instruction manual.

Triple-single type SDR controller

The triple-single type SDR controller is equipped with integrated pole-mount brackets. It can be installed on the recloser pole or substation frame at an operating height as preferred by the user.

The triple-single type SDR controller is equipped with a lockable door with a three-point latch and provision for a padlock. Behind the door is a swing panel, which contains the control and protection relay, miniature circuit breakers and a ground fault circuit interrupter (GFCI) safety outlet for a laptop. Behind the swing panel, there are printed circuit boards (PCB), rechargeable batteries and wiring connections.

The triple-single type SDR controller is equipped with a thermostat-controlled anti-condensation heater (space heater). The thermostat also controls the space heater in the switch unit. The heating is switched off above approximately 40° C.

PCB2: Switch unit driver (SUD): controls the magnetic actuator with monitoring of end positions, monitoring for broken cable and with discharge switch for the capacitors (PCB2 not included with the Schweitzer Engineering Laboratories, Inc. type SEL-651R recloser control relay option).

PCB3: Capacitors for magnetic actuator (PCB3 not included with the Schweitzer Engineering Laboratories, Inc. type SEL-651R recloser control relay option).

Note: The triple-single type SDR controller requires one PCB2 switch unit driver and one capacitor circuit board for operation with each of the three single-phase reclosers that comprise the triple-single type SDR recloser.

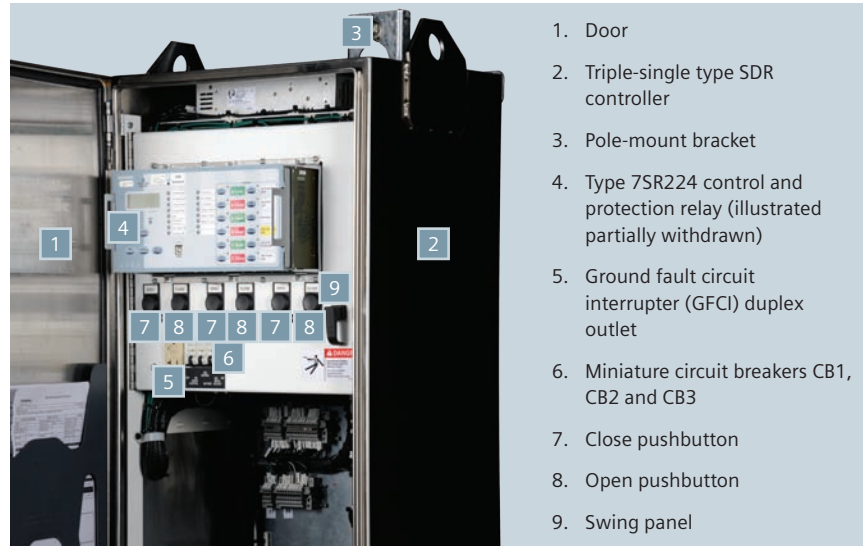

Figure 10: Triple-single type SDR controller with door open

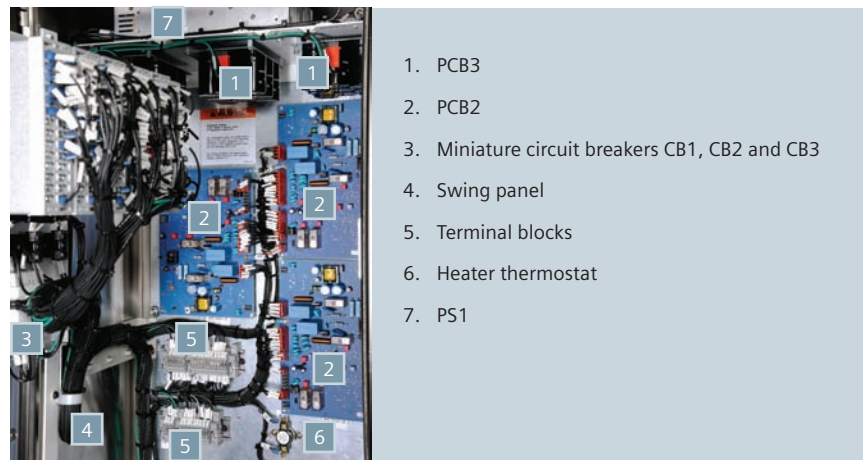
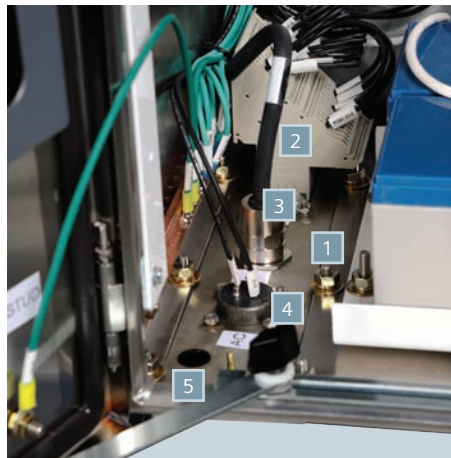

Figure 11: Triple-single type SDR controller with swing panel open



Figure 12: Space heater

Figure 13: Connector mounting plate, control cable connector, voltage sensor connector and optional antenna or auxiliary power connection



1. Connector mounting plate
2. Control cable connector
3. Optional voltage sensor connector
4. Optional auxiliary power connection
5. Optional antenna connector provision

Figure 14: Optional vandal guard



1. Optional vandal guard
2. Standard cable glands
3. Ground bolt connection

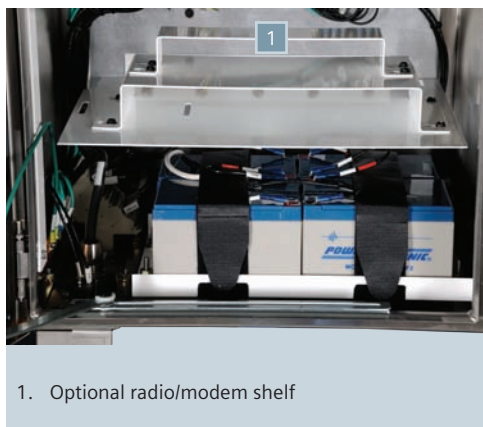

1. Optional radio/modem shelf

Figure 15: Optional radio/modem shelf



1. Optional door alarm

Figure 16: Optional door alarm

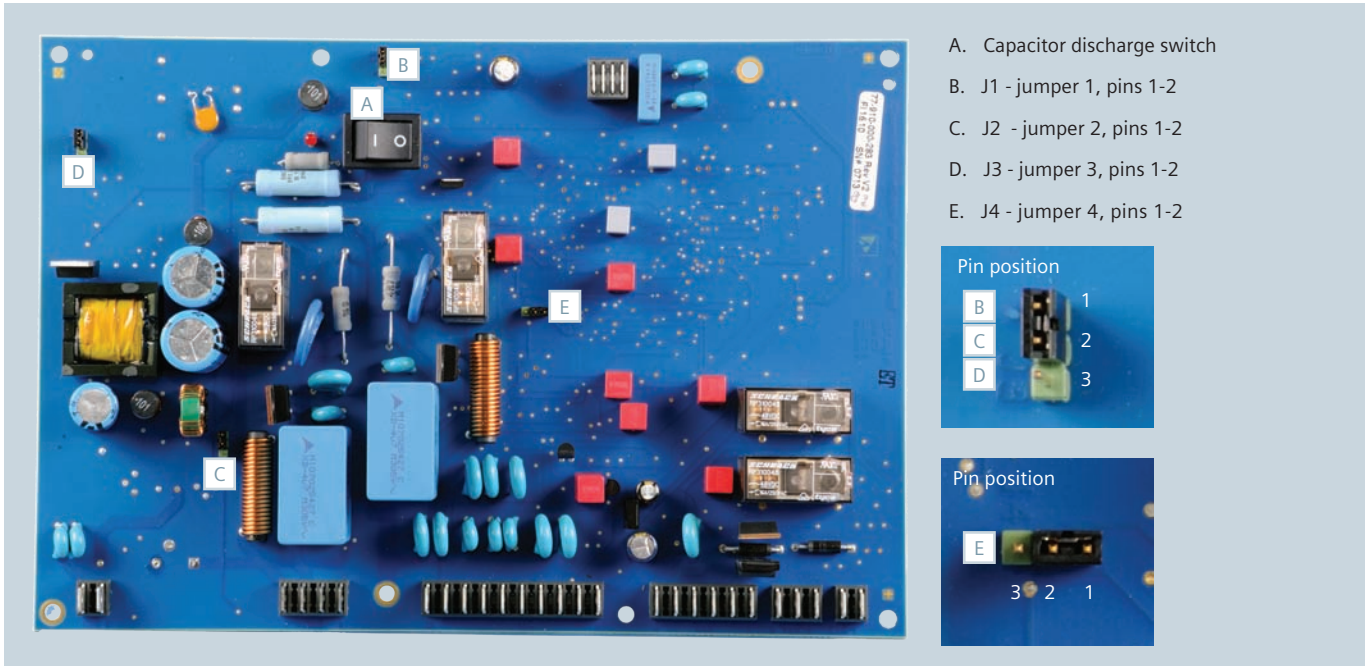



Figure 17: PCB2 jumpers

	<h2>⚠ WARNING</h2>
	<p>Hazardous voltage.</p> <p>Could result in serious injury or equipment malfunction.</p> <p>For maintenance work, the toggle switch (58) on PCB2 must be in the "discharge capacitors" position (position I). Do not work on the capacitor circuits when the red discharge LED is lit.</p> <p>For normal operation, the toggle switch (58) on PCB2 must be in the "operating" position (O).</p>

Discharge switch for the capacitors

The discharge switch on the switch unit driver (SUD) module/printed circuit board PCB2 serves to discharge the capacitors. In the "discharge capacitors" position (I), the capacitor charging operation is turned off and the capacitors are discharged via a resistor – discharge of the capacitors takes roughly one minute.

When capacitors are charged and the switch is changed from the "operating position" (O) to the "discharge capacitors" (I) position, the red LED next to switch illuminates.

When the discharging has reached a safe limit with a capacitor voltage below approximately 40 V, the LED no longer illuminates. Work on the capacitor circuits should only be performed once the LED no longer illuminates.

For normal operation, the switch must be brought into the "operating" position (O) as shown in Figure 17: PCB2 jumpers. In this position, the capacitors will be charged. The LED does not light up during normal operation.

Auxiliary power supply

The triple-single type SDR controller uses an internal 48 V bus, which is backed-up by rechargeable batteries as an uninterruptible power supply. The internal bus is energized by the power supply unit (PS1). It is connected to the auxiliary power provided on site, either through low-voltage supply or power transformer connected to the high-voltage line (optional). The charging of the batteries is temperature compensated by the power supply unit (for the location of PS1 refer to Figure 11: Triple-single type SDR controller with swing panel open on page 11.)

The incoming 120 Vac supply needs to be connected to the terminals on terminal block X1.

The power supply unit (PS1) is protected by the miniature circuit breaker CB1. CB1 also protects the ground fault circuit interrupter (GFCI) duplex outlet, which is supplied to provide power to the user's laptop computer.

The heaters are connected to the same incoming supply and are protected by the miniature circuit breaker CB2.

Rechargeable batteries

Four-12 V batteries are supplied with the recloser. They are to be installed in series on site (see Installation and commissioning on page 19). The batteries are protected by the miniature circuit breaker CB3. The batteries provide a minimum of 48 hours stand-by operation at 20 °C from a fully charged initial condition.

If miniature circuit breaker CB3 opens or trips, it disconnects the control power for the controller and the controller will neither operate the recloser nor protect the network. Control and protection functions restart automatically by closing CB3.

If the batteries are not in use, they should be recharged at intervals of six months.

Deep discharge protection (provided with the Siemens type 7SR224 control and protection relay)

The controller is equipped with deep discharge protection to avoid damage to the batteries if the auxiliary power supply is absent for an extended time.

In case of loss of auxiliary supply, the recloser will work as long as the internal bus voltage remains above 39 V. If the internal bus voltage goes below this limit, the voltage at the control relay binary input drops below the threshold level and a timer will start. This will create an entry to the event file and can be mapped to a general alarm. After a customer-settable time (default value is 30 minutes), the batteries will be disconnected from the electronics. The recloser is now completely inoperative and will remain in the state (open or closed) that it was in when the batteries were disconnected.

With returning auxiliary supply power, the controller will start-up and close the control relay binary output contact to connect the batteries to the power supply unit. The power supply is restored and the recloser returns to normal operation. The restoring can be delayed up to 2 minutes, caused by the reactivation of the power supply unit. Until the restoration process is complete, the recloser cannot be electrically switched from one position (closed or open) to the other.

Optional features

An optional power supply circuit can be provided for additional communication modules (radio unit or modem). It is directly connected to the auxiliary power supply through CB1 and not connected to the uninterruptible power supply.

Additional BI/BO may be provided as an option.

Receiving, handling and storage

	⚠ WARNING
	<p>Heavy weight.</p> <p>Can result in death, serious injury or property damage.</p> <p>Obtain the services of a qualified rigger prior to hoisting the recloser switch unit to assure adequate safety margins in the hoisting equipment and procedures to avoid damage.</p>

Introduction

This portion of the manual covers the receiving, handling and storage instructions for type SDR vacuum reclosers. This section of the manual is intended to help the user identify, inspect and protect the recloser prior to its installation.

Receiving procedure

Make a physical inspection of the shipping container before removing or unpacking the recloser. Check for shipment damage or indications of rough handling by the carrier. Check each item against the manifest to identify any shortages.

Shipping damage claims (when applicable)

Follow normal shipment damage procedures, which should include:

1. Check for visible damage upon arrival.
2. Visible damage must be noted on delivery receipt and acknowledged with driver's signature. Notation "Possible internal damage, subject to inspection" must be on delivery receipt.

3. Notify the Siemens field service at +1 (800) 347-6659 or +1 (919) 365-2200 outside the U.S.
4. Arrange for carrier's inspection. Do not move the unit from its unloading point.

Handling procedure

1. Carefully remove the packing material from the recloser. Keep the shipping pallet for later use if the recloser is to be stored prior to its installation.
2. Inspect for concealed damage. Notification to carrier must take place within 15 days to assure prompt resolution of claims.
3. The recloser should be appropriately lifted to avoid damaging the recloser.
4. The palletted recloser can also be moved using a properly rated forklift vehicle. The pallets are designed for movement by a standard forklift.

Storage procedure

Whenever possible, store the recloser indoors. The storage environment must be clean, dry and free of such items as: construction dust, corrosive atmosphere, mechanical abuse and rapid temperature variations.

Space heating

Space heating for the controller must be used for both indoor and outdoor storage to prevent condensation and corrosion. The controller space heater should be connected to a 120 Vac auxiliary supply at terminal block X1 as discussed in "Connecting the auxiliary voltage supply" on page 21 of this instruction manual. (Refer to the wiring diagrams provided with the order specific drawings for terminal numbers and terminal block location.) After these connections have been made, circuit breaker CB2, as shown on Figure 10, must be switched to the "on" position.

Installation and commissioning

	⚠ DANGER
	<p>Hazardous voltages. Will cause death, serious injury or property damage.</p> <p>To avoid electrical shock or burns, this equipment must be installed, operated and maintained only by qualified persons thoroughly familiar with the equipment, instruction manuals and drawings.</p>

	⚠ WARNING
	<p>Heavy weight. Can result in death, serious injury or property damage.</p> <p>Obtain the services of a qualified rigger prior to hoisting the recloser switch unit to assure adequate safety margins in the hoisting equipment and procedures to avoid damage.</p>

This section provides information about the installation and commissioning with regard to the following:

- Required documents
- Personnel requirements
- Tools, devices and expendable materials to be used
- Safety
- Recording/documentation.

Mechanical installation

The following documents are required for installation:

- These operating instructions
- Order specific drawings
- Installation and commissioning report form (see page 32).

A responsible person (or supervisor) must be assigned to oversee the installation and commissioning work. This person must instruct personnel during installation and commissioning tasks, and check for compliance with the applicable safety procedures.

The installation and commissioning work must be performed by authorized personnel who must be qualified persons as described on page 2 of this instruction manual.

Suitable lifting apparatus in good working condition and transport vehicles with sufficient load-bearing capacity must be used for installation.

All safety regulations, including NFPA 70E and OSHA regulations, must be observed.

Installation and commissioning must be documented (see "Installation and commissioning report," page 32).

Torque requirements for all hardware are as follows:

- .38 inch: (31 lbf-ft ± 5 lbf-ft)
- .50 inch: (75 lbf-ft ± 9 lbf-ft)
- .62 inch: (120 lbf-ft ± 20 lbf-ft)
- .75 inch: (250 lbf-ft ± 40 lbf-ft).



Figure 18: Lifting of the switch units

Preparatory work

Both the installation and commissioning report (see page 32) and these installation instructions are based on the sequence of the work to be performed. The on-site conditions may result in deviations from the sequence shown.

The following preparatory work must be performed:

- Instruct installation and maintenance personnel with regard to:
 1. Safety
 2. Cleanliness at installation site
 3. Safety markings
 4. Dealing with incidents or unexpected conditions
- Check delivery documents for completeness
- Check all shipping units for shipping damage
- Inspect power pole ground conductor and install ground conductor, if necessary
- If installation is on a substation frame, check the foundation for the substation frame and install ground connection, if required.

Mounting the recloser on the pole

The recloser is mounted in several steps. Refer to the frame installation drawing provided with the order specific drawings for information on mounting frames.

Lifting the recloser switch units

Figure 18: Lifting of the switch units shows the proper technique for lifting the single-phase switch unit and the triple-single recloser with mounting frame. The lifting cables should be attached to all four lifting lugs and the lifting cables must not touch the encapsulated pole units.

Installation of the triple-single type SDR controller on the pole

To attach the triple-single type SDR controller the following components are required:

- Two 0.75 inch mounting bolts with nuts and washers (length equal to pole diameter plus four inches; not included in scope of delivery)
- Triple-single type SDR controller
- Batteries.
 1. Insert upper mounting bolt through the pole (hole spacing 40.5 inches (1,029 mm)).
 2. Lift triple-single type SDR controller with two cables using the lifting eyes and fasten to the upper mounting bolt. Tighten nut by hand.
 3. Align triple-single type SDR controller and insert lower mounting bolt through the pole and fasten.
 4. Tighten bolted connections and check stability.
 5. Install the four batteries with terminals facing towards each other (per Figure 20) and secure with the hook and loop fastener strap.
 6. Fasten temperature sensor on the battery using a hook and loop fastener strap.
 7. First connect the positive terminal, then connect the adjacent terminals of two batteries using the short connecting cables and finally connect the negative terminal to the triple-single type SDR controller connection. Make sure the connections have the correct polarity (compare with the labeling on the cables).

Note: Avoid incorrect polarity of batteries. Connecting the rechargeable batteries with the wrong polarity will result in damage to the controller electronics (PCB2) and also misoperation of the recloser.

Connection covers

The control and (optional) voltage sensor cable connections are supplied with covers at the recloser switch unit and the controller. When connecting the cables, the covers should be stored in a clean and dry environment, such as the controller enclosure, in case of later use during disconnection of the cables.

Electrical installation

The following must be carried out in order to establish the electrical connections:

- Establish the ground (earth) connection,
- Connect the recloser switch unit to the triple-single type SDR controller,
- Connect the auxiliary voltage, and
- Establish the high-voltage connection.

Establishing the ground (earth) connection

Both the recloser switch unit and the triple-single type SDR controller must be connected to the pole ground (earth) or ground (earth) in the substation. If surge arresters are installed, these must also be securely grounded (earthed).

For correct grounding (earthing), the following must be observed:

- The recloser (switch units plus triple-single type SDR controller) must be grounded (earthed) in accordance with local regulations and work practices.
- The cable to be used must be suitable for grounding (earthing). This particularly applies for the cross section of the grounding (earthing) cable and connections.
- The cables (control and optional voltage sensor cable) must be installed as close together as possible with the ground (earth) conductor (see Figure 23: Connection of cables and grounding (earthing) of recloser on page 20). Ideally they should be bundled together.

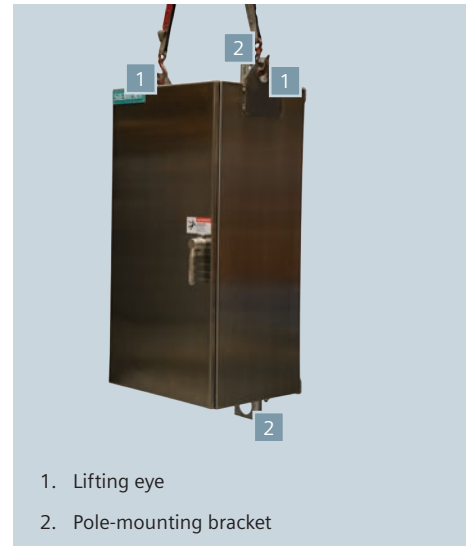

Figure 19: Lifting of control cubicle

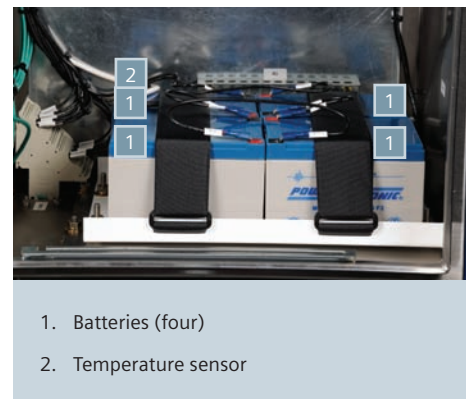

Figure 20: Installation of batteries

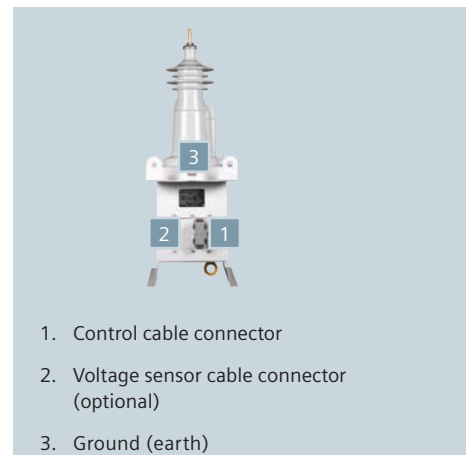
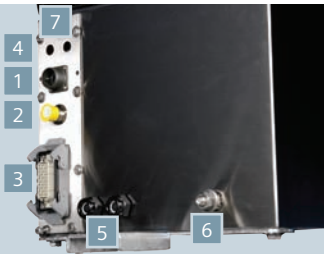

Figure 21: Single-phase recloser switch unit connections (rear view)



1. Connector for auxiliary power supply (optional)
2. Connector for voltage sensor cable (optional)
3. Connector for control cable
4. Antenna connector provision (optional)
5. Standard cable glands for user-interface cables
6. Ground bolt connection
7. Connector mounting plate

Figure 22: Triple-single type SDR controller connections



Figure 24: Cables

1. Recloser switch units
2. Surge arrester load side (optional)
3. Ground terminal (switch unit)
4. Ground connection for surge arrester (optional)
5. Ground wire
6. Control cable
7. Triple-single type SDR controller
8. Ground terminal .5" stud (controller)
9. Ground level
10. Pole ground

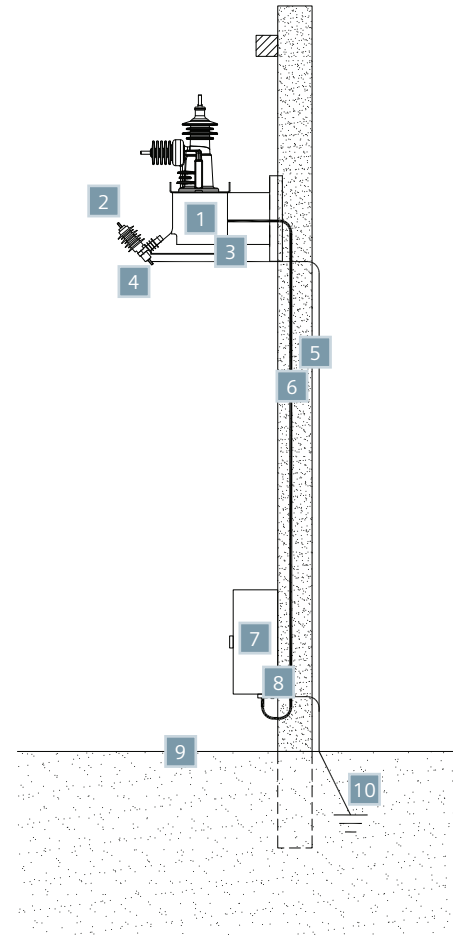

Figure 23: Connection of cables and grounding (earthing) of recloser

Connect cables between recloser switch units and triple-single type SDR controller

1. Connect control cable to the recloser switch unit poles and triple-single type SDR controller. The type SDR triple-single recloser control cable consists of two parts. The lower cable has a 40-pin connector on the end that connects to the type SDR triple-single controller. The end nearest to the recloser switch units has a 64-pin in-line weatherproof connector. The upper cable has a mated 64-pin connector with three leads at least four feet in length. Each lead is marked with the phase identification of the corresponding recloser switch unit pole. The connection on the control cable is protected against polarity mismatch.
2. Secure plugs to prevent them from loosening using the locking clip.
3. Connect voltage sensor cable (optional) to the recloser switch unit poles and triple-single type SDR controller. The type SDR triple-single recloser voltage sensor consists of two parts. The lower cable has a 12-pin connector on the end that connects to the type SDR triple-single controller. The end nearest the recloser switch units has a 10-pin in-line weatherproof connector. The upper cable has a mated 10-pin connector with three leads at least four feet in length. Each lead is marked with the phase identification of the corresponding recloser switch unit pole. The connection on the sensor cable is protected against polarity mismatch.

4. Check plugs are inserted correctly and secured.
5. Fasten the control and sensor cable to the pole using appropriate means (for example, cable ties, Electrical Materials Company U-Guard™ and clamps). Cables must be clamped so that the weight of the cables does not hang from the connection housing or terminal plug.
6. Loop and fasten excess lengths of cable in the area below the pole-mounting frame at the highest position possible.
7. Cable ties or clamps should be no more than six feet apart on the pole.

Note: The phase sequence may be changed by switching the control cable and optional voltage sensing cable connections at the rear of each recloser switch unit pole. The sequence may also be changed using the control and protective relay software.

Connecting the auxiliary voltage supply

The auxiliary voltage is supplied either by an external transformer or an external low-voltage power supply. In both cases, insert the connection cable through the cable gland (see Figure 22: Triple-single type SDR controller connections on page 20) into the triple-single type SDR controller and attach to the corresponding terminals at terminal block X1.

Refer to the wiring diagrams supplied with the order specific drawings for terminal numbers and terminal block location.

Optional provision for connectorized power supply cables may be provided as shown in Figure 22: Triple-single type SDR controller connections on page 20.

Establishing high-voltage connection

The recloser switch unit is equipped with terminal connectors to fasten cables or with flat spade connectors, depending on the configuration specified by the purchaser.

Commissioning

The equipment must be commissioned as follows. The installation and commissioning report (see page 32) serves as documentation and a checklist.

Function and operational instructions



For functional test and operational instructions for use with the type SDR triple-single controller, refer to the vendor website information in Annex A on page 38.

Only the Siemens type 7SR224 control and protection relay option is illustrated in this instruction manual.



1. Thermostat
2. X1 (auxiliary power supply)
3. X4 (customer connections)
4. X2 (internal connections)
5. X3 (internal connections)

Figure 25: Typical terminal block arrangement (terminals for the type 7SR224 control and protection relay illustrated)

	 <h2 style="margin: 0;">DANGER</h2>
	<p>Hazardous voltages.</p> <p>Will cause death, serious injury and property damage.</p> <p>Do not contact energized conductors.</p> <p>De-energize and ground the equipment before working on or near high voltage conductors.</p>

Operation



1. Controller enclosure
2. Control and protection relay
3. Open pushbutton
4. Close pushbutton

Figure 26: Controller with control and protection relay

Operation

The recloser is just one device in a distribution system. The user of the recloser must set the controller protection and control parameters to suit the user's distribution system needs, and to provide reliable, safe and trouble-free operation of the recloser.

Safety instructions for operation

In addition to the local safety rules and work practices, special precaution must be taken:

- The accessories required to operate the recloser must be stored in a clean location and must be checked regularly for completeness and good condition.
- All keys must be accessible only to the authorized operating personnel.
- No modifications should be made to the recloser. This includes, but is not limited to, removal of parts, opening the operating mechanism housing and any modification (including adjustment) of the drive system of the recloser.
- The control cable and the optional voltage sensor cable must not be removed during operation. Removing these cables would mean no further electrical operation could be performed and no measurement values or other signals could be sent from the recloser switch units to the controller.

Switching

Switching comprises electrical switching (remote and/or local operation) and mechanical switching (by means of the lockout handles).

Switching is carried out automatically by the controller to protect the network by remote control or manually on site.

Local operation

Local operation describes the manual electrical switching of the reclosers on site. Manual switching using the lockout handles is discussed in the Lockout operation section of this instruction manual on page 23.

These switching actions can be carried out from the controller using the Close/Open pushbuttons or using the function buttons on the control and protection relay. Refer to page 23 for more information.



⚠ DANGER

Hazardous voltages.

Will cause death, serious injury or property damage.

Always de-energize and ground the equipment and all terminals before performing any work near high-voltage conductors.

Work on the recloser switch unit or the control cubicle should be performed only by qualified personnel.

Do not open the inner panel of the control cubicle, as interior parts energized at voltages higher than 50 V are present.

Do not disconnect control or sensor cables while recloser is energized, as connectors contain energized parts.

Modes of operation

The type SDR triple-single recloser has three modes of operation:

- Mode A, **3P Trip/3P LO** allows the three single-pole reclosers to operate in the three-pole mode as a standard three-phase recloser. All open and close commands are issued to all three poles simultaneously. Any protection element operation for any phase will trip all three phases and all three phases will lockout during a failed auto-reclose sequence.
- Mode B, **1P Trip/3P LO** provides single-pole tripping and auto-reclose. All open and close commands are issued to all three poles simultaneously. Any protection element operation for any phase trips only the affected phase when auto-reclose is turned on. If any auto-reclose sequence is not successful or if auto-reclose is turned off, any protection element trips all three phases and all three phases will lockout.
- Mode C, **1P Trip/1P LO** allows the three poles of the reclosers to operate independently for faults that only affect one phase. All open and close commands are issued to each pole independently. Any protection element operation for any phase trips only the affected phase. Auto-reclose operates separately for each phase. After an unsuccessful auto-reclose sequence, each phase will lockout independently.

Lockout operation

Lockout operation combines the mechanical tripping/opening of the recloser pole or poles and the interlocking to inhibit subsequent closing of the recloser pole or poles.

The lockout can also be operated when under load.

For a triple-single recloser, each of the three poles will be mechanically operated individually. The poles may be electrically linked by the controller if the three-phase trip and lockout is selected.

Open the recloser

1. Using a hot stick or suitable rod from the ground, pull down the lockout handle of the selected phase recloser pole until it reaches the end (lower) position.

- The recloser pole opens. By operating the lockout mechanism, the recloser pole is opened mechanically and locked in this position.
- The mechanical position indicator on the bottom of the recloser switch unit pole shows green.
- The green OPEN LED for the selected phase recloser pole on the protection and control relay indicates the switch unit pole has operated.
- If three-phase trip and lockout is selected from the controller, the poles may be electrically linked. In this case, all three poles will trip and lockout electrically.
- The switch action is completed.

As long as the lockout handle is pulled out, it is not possible to close the selected phase recloser pole or poles electrically, whether locally or from a remote location.

Note: All three recloser poles must be mechanically locked out to prevent electrical operation of individual poles in the case that the single-phase mode of operation is selected from the controller.

Closing the recloser electrically from the controller

1. Using a hot stick or suitable rod from the ground, push the lockout handle of the locked out recloser pole back in completely.
2. Follow the control and protection relay instructions to electrically close the recloser pole or poles.

- The selected phase recloser pole or poles closes.
- After switching, confirm that the red CLOSED LED on the control relay indicates the switch position has been reached for the selected phase recloser pole or poles.
- Confirm the green OPEN LED is off for the selected phase recloser pole or poles.
- The switch action is complete.
- The mechanical position indicator on the bottom of the recloser switch unit shows red for the selected phase recloser pole or poles.

Note: The lockout handle needs to be pushed back completely. Otherwise, the interlocking still prevents closing.



Figure 27: Lockout handle with ring for manual operation (pushed in, normal operation)



Figure 28: Lockout handle with ring for manual operation (pulled out, recloser open and locked out)



Figure 29: Bottom view of fully assemble triple-single recloser with phase B locked out

Table 2: Troubleshooting

Malfunction	Remedy
Failure of the auxiliary power supply (for example, "Aux power OK" LED does not light up).	<p>The auxiliary power supply is protected by a miniature circuit breaker in the front of the swing panel.</p> <ol style="list-style-type: none"> 1. Check miniature circuit breaker CB1 and switch on if necessary. 2. Check the status of the external auxiliary power supply.
Ground fault circuit interrupter (GFCI) duplex outlet does not work.	<p>The ground fault circuit interrupter (GFCI) is protected by a miniature circuit breaker in the front of the swing panel.</p> <ol style="list-style-type: none"> 1. Check miniature circuit breaker CB1 and switch on if necessary. 2. Check the status of the external auxiliary power supply.
Heating does not work	<p>The heaters are protected by a miniature circuit breaker (in the front of the swing panel).</p> <ol style="list-style-type: none"> 1. Check miniature circuit breaker CB2 and switch on if necessary.
Failure of batteries	<p>The batteries are protected by a miniature circuit breaker (in the front of the swing panel).</p> <ol style="list-style-type: none"> 1. Check miniature circuit breaker CB3 and switch on if necessary. 2. Check the battery status via the protection and control relay menu or monitoring device and replace batteries if necessary.
Closing of a recloser pole or poles is blocked	<p>Manual lockout handle or handles is not fully returned to (pushed in) starting position.</p> <ol style="list-style-type: none"> 1. Push manual lockout handle or handles back in completely.
Incomplete recloser cycle > only switching off is possible	<p>Auxiliary power supply may be inadequate or capacitors may be faulty. In this case, the controller's self-monitoring function can block the full cycle.</p> <ol style="list-style-type: none"> 1. Check fault messages from the protection and control relay.
Controller does not start up	<ol style="list-style-type: none"> 1. Check the auxiliary power supply to confirm it is turned on (connected and CB1 is switched on). Otherwise, the deep discharge protection will prevent the controller from starting up.

Maintenance

	⚠ DANGER
	<p>Hazardous voltages.</p> <p>Will cause death, serious injury or property damage.</p> <p>Always de-energize and ground the equipment and all terminals before performing any work near high-voltage conductors.</p> <p>Work on the recloser switch unit or the control cubicle should be performed only by qualified personnel.</p> <p>Do not open the inner panel of the control cubicle, as interior parts energized at voltages higher than 50 V are present.</p> <p>Do not disconnect control or sensor cables while recloser is energized, as connectors contain energized parts.</p>

General

The recloser switch unit of the SDR vacuum recloser is designed to require no maintenance for 10,000 operating cycles under ANSI/IEEE C37.60 "usual service conditions." Regular monitoring and, if need be, replacement of the batteries is necessary for the triple-single type SDR controller. Regular maintenance is required for components in the controller, primarily consisting of checks of cleanliness, tightness of connections, battery test and similar activities.

Maintenance plan

The following work should be carried out as part of regular inspections reflected in Table 3.

Spare parts

Parts must be replaced only by instructed and certified personnel. Refer to list in Table 4.

Table 3: Maintenance plan

Work to be performed	Recommended interval
Visual inspections: 1. Terminals clean and undamaged 2. No visible corrosion or damage to metal parts and cables 3. No loose parts (for example, bolts or connections) 4. Ground (earth) connections secure and undamaged 5. Labeling clearly legible 6. Triple-single type SDR controller undamaged and correctly secured.	12 months (adjust interval according to experience)
Function tests: 1. Control and protection relay indicates fault-free operation of the auxiliary power supply, batteries and capacitors (monitoring LEDs) 2. Fault-free operation of communication modules 3. Perform battery test or check result of last battery tests at the control and protection relay.	12 months (as part of visual inspection)
Protection tests: 1. Protection test using secondary injection equipment, in conjunction with recloser function test (see the Installation and commissioning section of the control and protection relay instruction manual) 2. Function test of lockout handles.	Four years (adjust interval according to experience)
Reset counter "Switching operations since last visit" (refer to control and protection relay instructions)	Following every maintenance session

Table 4: Spare parts

Accessory/spare part	Order number
Surge arresters (3EK7)	On request
Auxiliary power supply (PS1)	On request
Switch unit driver (PCB2)	On request
Capacitor board (PCB3)	On request
External current transformer	On request
External voltage transformer	On request
Transformer for auxiliary voltage supply	On request
Current/voltage transformer pole-mount frame	On request
Control cable	On request
Voltage sensor cable	On request
Cover for position indicator	On request
Animal guards	On request
Set of terminal connectors (six pieces)	On request
Set of batteries (four batteries, 12 Ah, 48 V)	On request
Heaters	On request
Type SDR 15.5 kV to 27 kV triple-single distribution recloser instruction manual	E50001-F710-A412-X-XXXX

Technical data

Characteristic	Unit	Voltage class	
Rated maximum voltage U_r	kV	15.5	27.0
Rated continuous current I_r	A	630, 800	630, 800
Rated lightning impulse withstand voltage U_p	kV	110	125
Power frequency insulation level withstand test voltage (one minute dry) U_d	kV	50	60
Rated symmetrical interrupting current I_{sc}	kA	12.5, 16	12.5
Rated asymmetrical making current (rms)	kA	20, 25	20
Rated peak making current	kA	32.5, 41	32.5
Mechanical life (operating cycles)	OPS	10,000	10,000
Permissible short-circuit operations	OPS	up to 250	up to 250
Ambient temperature range	°C	-40 to +55	-40 to +55
Centerline spacing between phases	in (mm)	14.8 (376)	14.8 (376)
Flashover distance	Unit		
Phase/phase	in (mm)	12.3 (312)	12.3 (312)
Phase/ground (earth)	in (mm)	10.4 (265)	10.4 (265)
Creepage distance	Unit		
Phase/ground (earth)	in (mm)	31.9 (810)	31.9 (810)
Between line-side and load-side terminal	in (mm)	46.1 (1,170)	46.1 (1,170)

Table 5: Main characteristic data

Protective function	Unit	Minimum trip current	
Phase faults	A	40	40
Ground (earth) faults	A	4	4
Sensitive ground (earth) faults	A	4	4

Table 6: Minimum trip currents

Operation time	Unit	Time	
Closing time	ms	<60	<60
Opening time	ms	<35	<35
Arcing time	ms	<15	<15
Interrupting time	ms	<50	<50

Table 7: Operating times

Dead time	Unit	Time range	
Dead time after first open	s	0.2 to 14,400	0.2 to 14,400
Dead time after second and third open	s	2 to 14,400	2 to 14,400
Dead time after fourth open	s	30 to 14,400	30 to 14,400

Table 8: Dead times for recloser cycle (reclosing interval)

Current transformer data

The current transformer has a ratio of 800:1. The accuracy is 0.5 VA 5P20 to IEC 60044-1.

Voltage sensor data (optional)

The ratio of the voltage sensors is adapted to operation with the control and protection relay and provides a $110 \text{ V}/\sqrt{3}$ secondary signal when the recloser is energized at rated maximum voltage.

Ambient conditions

The type SDR vacuum recloser is suitable for use under "usual service conditions" as given in IEEE standard C37.60/IEC 62271-111, as follows:

- Ambient temperature -40°C to 55°C
- Solar radiation $<1,120 \text{ W}/\text{m}^2$
- Altitude $<1,000 \text{ m}$ or less

Altitude correction factor

The insulating capability of insulation in air decreases as the altitude increases due to the reduced air density. The rated lightning impulse withstand voltage values (see Table 5) are valid according to IEC 62271-1 and IEEE C37.60 up to an installation height of 1,000 m above sea level. Above a height of 1,000 m, the insulation level must be corrected in line with Figure 30.

Example: At 2,500 m altitude, a unit rated 110 kV BIL under "usual service conditions" will have a lightning impulse withstand capability of:

$$\frac{110}{K} = \frac{110}{e^{m(h-1000)/8150}} = \frac{110}{1.2} = 91.5 \text{ kV}$$

Table 9: Power consumption

Auxiliary system	Unit	Power consumption
Auxiliary power requirement, controller	W	<15, typically <10
Auxiliary power requirements, heating (controller and switch unit)	W	Control cubicle = 37.5, switch unit = 50
Auxiliary power requirement, communication (dependent on modem or radio used)	W	<15 typical
External requirements (external user, for instance, laptop)	A	2 (if supplied by auxiliary transformer); 10 (if connection to low-voltage network)

Figure 30: Altitude correction factor K

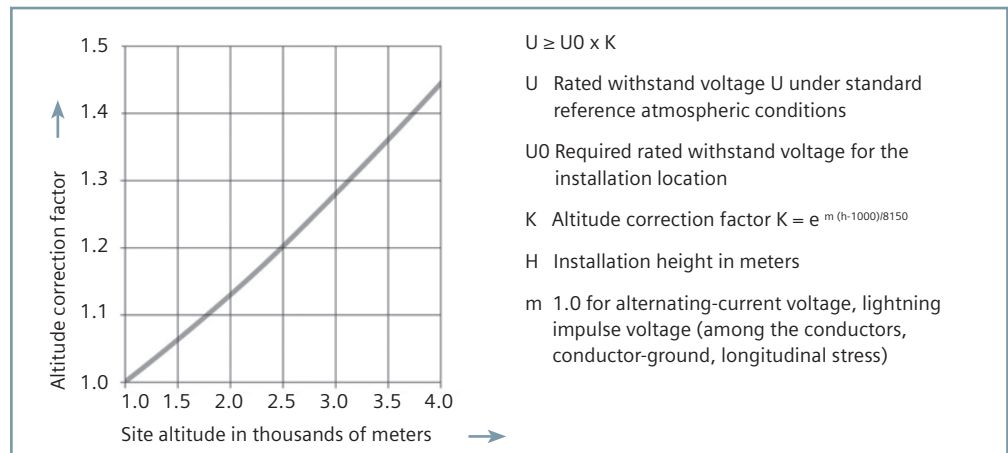

Rated voltage U:	Unit	15.5 kV and 27.0 kV
Dimensions: length x width x height	in (mm)	46.3 (1,176) x 26.9 (673) x 42.8 (1,087)
Weight	lbs (kg)	450 (204)

Table 10: Switch unit dimensions and weights (without frame)

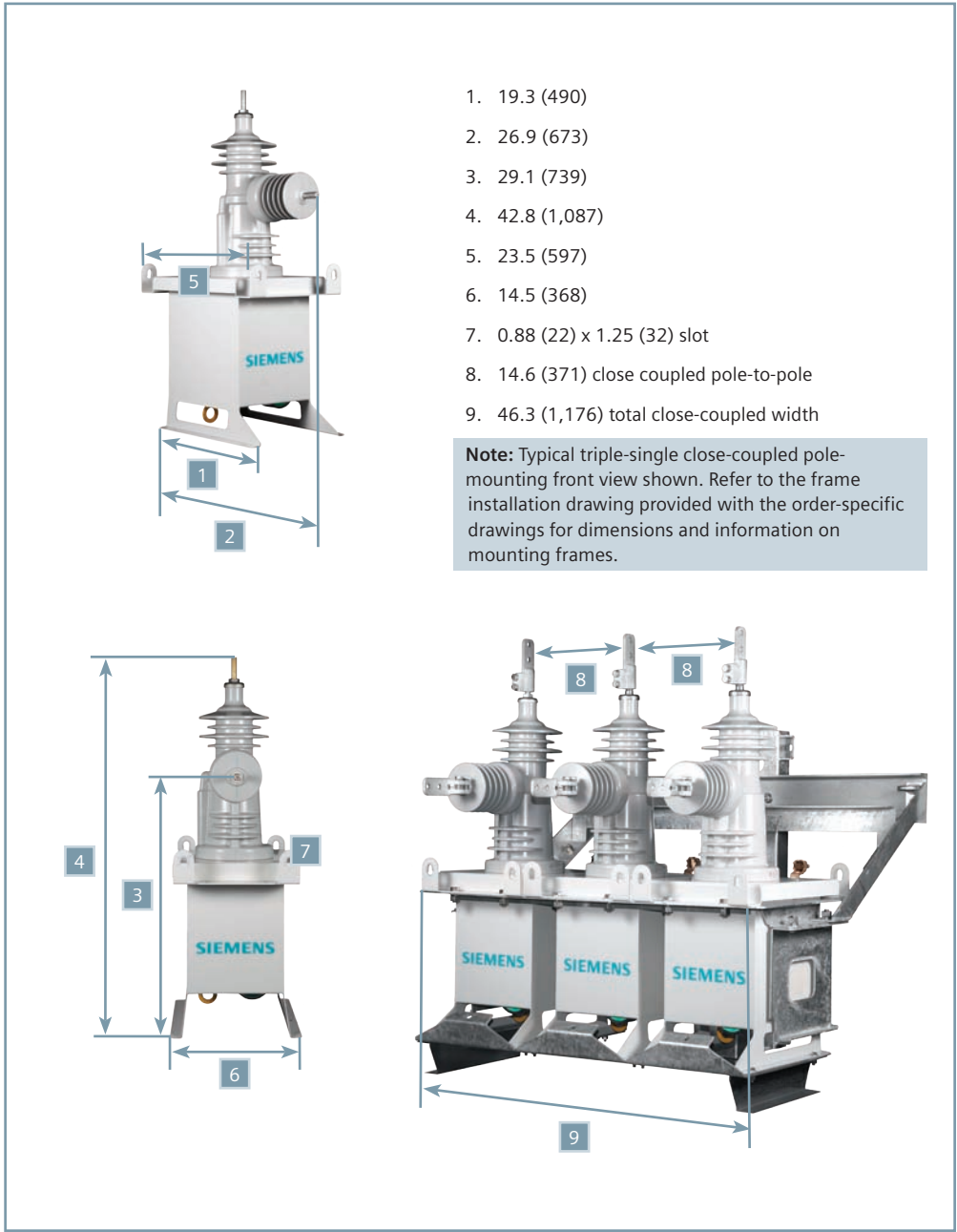

Figure 31: Recloser switch unit dimensions in (mm)

Table 11: Controller

Rated voltage U _r		All voltages
Dimensions: length x width x height (without pole-mount brackets)	in (mm)	18.0 (457) x 14.0 (356) x 36.0 (914)
Weight (without batteries)	lbs (kg)	150 (67)

Figure 32: Controller dimensions in (mm)

1. 18.0 (457)
2. 14.0 (356)
3. 36.0 (914)
4. 40.5 (1,029) center line pole-mounting bracket bolt holes



A stainless steel nameplate is located at the rear of the recloser switch unit. A corresponding rating label is located on the left wall inside the triple-single type SDR controller. This label identifies the serial number of the controller and switch unit that were tested as a complete assembly per IEEE C37.60.

Switch nameplate

1 SIEMENS		7	
Vacuum Recloser		8 Design code	
2 WOD Serial No. 3AD/00000000	9 Year of manuf.		
3 U_r kV	10 I_r	A	
4 U_p kV	11 I_{sc}	kA	
5 U_d kV	12 m	kg	
6 Order Code		13 ANSI C 37.60	
MADE IN GERMANY			

Controller nameplate

1 SIEMENS	
CONTROL CABINET tested with RECLOSER SWITCH	
Product Type/Style 14	Switch Manufacturer 1
Sales Order No. 15	Switch Type 17
Sales Item No. 16	Switch A Serial No. 2
Serial No. 2	Switch A Prod. Date 9
Production Date 9	Switch B Serial No. 2
Weight 12	Switch B Prod. Date 9
	Switch C Serial No. 2
	Switch C Prod. Date 9
	U_r 3
	U_p 4
	U_d 5
13 IEEE C37.60	I_r 10
MADE IN USA	I_{sc} 11
Order Code 6	
Instruction Manual No. 18	
Siemens Industry, Inc. 7000 Siemens Road, Wendell, NC 27591	
18-762-111-050	

Figure 33: Nameplates

1. Manufacturer
2. Serial number
3. Rated maximum voltage U_r
4. Rated lightning impulse withstand voltage U_p
5. Rated short-time withstand voltage (60s) U_d
6. Type designation/order number
7. Quality control stamp
8. Design code
9. Date of manufacture/production date
10. Rated continuous current I_r
11. Rated symmetrical interrupting current I_{sc}
12. Weight
13. Standard
14. Product type/style
15. Sales order number
16. Sales item number
17. Switch type
18. Instruction manual code

Installation and commissioning report

Installation and commissioning report

The installation and commissioning report on the following pages is intended for using and copying as a checklist.

Installation and commissioning report

Type SDR distribution recloser

User

Siemens Type SDR

Location

Recloser type

Contract number

Serial number

Rated maximum voltage (kV)

Rated continuous current (A)

Auxiliary voltage

Rated short-circuit current (kA)

Table 12 is based on the Siemens type 7SR224 control and protection relay option for the triple-single type SDR controller.

Refer to page 22 for function test and operational instructions for other optional control and protection relays. Apply these instructions as applicable to complete the checklist.

Table 12: Preparatory tasks

Item	Checklist	Notes
A.01	Installation and commissioning personnel have received instruction and meet the conditions for "Qualified person" (see page 2): <ul style="list-style-type: none"> ■ Occupational safety ■ Safety markings ■ Transit damage. 	
A.02	The recloser (switch unit and controller) is visually in good condition and undamaged.	
A.03	Any paint damage occurring during transport and installation has been repaired.	
A.04	All accessories and special equipment ordered are available/ assembled at the installation site.	
A.05	Pole or foundation is in suitable condition.	
A.06	Grounding (earthing) is sufficient and in accordance with local regulations.	
A.07	Compare the correct voltage of the recloser. (For example, compare the rated voltage of the recloser with the system voltage. Contact Siemens customer service if the voltage is incorrect at +1 (800) 347-6659 or +1 (919) 365-2200 outside the U.S.)	

Table 13: Visual inspections after installation

Item	Checklist	Notes
B.01	All bolted connections and other assembly elements are tight.	
B.02	Batteries are installed correctly: <ul style="list-style-type: none"> ■ All four are connected in series ■ Contacts point to the center of the battery tray. ■ Polarity labeling on the supply wires on the left and right correspond to actual connection of the batteries ■ Hook and loop straps are over the batteries and fastened tightly. 	
B.03	Temperature sensor is in contact with a battery and secured (see Figure 20).	
B.05	Cross-sectional area of the ground (earth) connection is adequate or the required ground current and connection to the switch unit is secure.	
B.06	Auxiliary voltage is connected correctly per order specific wiring diagram.	
B.07	Capacitor discharge switches are in the operating position. Switch must be in position "O" (see Figure 17).	

Table 14: Function checks

Item	Checklist	Notes
C.01	Switch on miniature circuit breakers: CB1 and CB3 (behind the panel): <ul style="list-style-type: none"> ■ Start-up of controller is shown on display. ■ "Protection healthy" LED lights green after approximately 30 seconds ■ Status LED "AuxPower OK" lights up green ■ Status LED "Recloser OK" lights up green ■ LED next to the Open function buttons light up green ■ Position indicator on the bottom of the recloser switch unit is green (open). 	
C.02	Select "Mode A: 3PTrip3Plo" from control and protection relay using the control mode.	
C.03	Press the Close pushbutton for either phase A, B or C: <ul style="list-style-type: none"> ■ Recloser for each phase closes. ■ LED next to the Open function button for each phase is no longer lit ■ LED next to the Close function button for each phase lights up red ■ During switching, the "Recloser OK" status LED goes out briefly (capacitors are charged for the next switching operation). Within 1 s, the status LED lights up green again. A longer period indicates the charging level of the batteries is very low or CB3 is not switched on. ■ Position indicator on the bottom of the recloser switch unit for each phase is red. 	
C.04	Press the Open pushbutton for either phase A, B or C: <ul style="list-style-type: none"> ■ Recloser for each phase opens ■ LED next to the Close function button for each phase is no longer lit ■ LED next to the Open function button for each phase lights up green ■ Position indicator on the bottom of the recloser switch unit for each phase is green (open). 	
C.05	Press the Close function button on the control and protection relay for either phase A, B or C and then press <Enter>: <ul style="list-style-type: none"> ■ Recloser for each phase closes ■ LED next to the Open function button for each phase is no longer lit ■ LED next to the Close function button for each phase lights up red ■ During switching, the "Recloser OK" status LED goes out briefly ■ Position indicator on the bottom of the recloser switch unit for each phase is red. 	
C.06	Press the Open function button on the control and protection relay for either phase A, B or C and then press <Enter>: <ul style="list-style-type: none"> ■ Recloser opens for each phase ■ LED next to the Close function button for each phase is no longer lit ■ LED next to the Open function button for each phase lights up green ■ Position indicator on the bottom of the recloser switch unit for each phase is green (open). 	
C.07	Press the Close pushbutton or the Close function button on the control and protection relay for either phase A, B or C and then press <Enter>: <ul style="list-style-type: none"> ■ Recloser for each phase closes ■ LED next to the Open function button for each phase is no longer lit ■ LED next to the Close function button for each phase lights up red ■ Position indicator on the bottom of the recloser switch unit for each phase is red. 	

Table 14: Function checks
(continued)

Item	Checklist	Notes
C.08	<p>Mechanical operation of the recloser by pulling the lockout handle for either phase A, B or C:</p> <ul style="list-style-type: none"> ■ Recloser opens for each phase ■ LED next to the Close function button for each phase is no longer lit ■ LED next to the Open function button for each phase lights up green ■ Position indicator on the bottom of the recloser switch unit for each phase is green (open). 	
C.09	<p>Press the Close pushbutton for either phase A, B or C:</p> <ul style="list-style-type: none"> ■ No switching operation shall take place. 	
C.10	<p>Press the Close function button for either phase A, B or C on the control and protection relay and then press <Enter>:</p> <ul style="list-style-type: none"> ■ No switching operation shall take place. 	
C.11	<p>Push lockout handle back in completely:</p> <ul style="list-style-type: none"> ■ Press Close pushbutton or the Close function button on the control and protection relay for either phase A, B or C and then press <Enter> ■ Recloser closes for each phase ■ LED next to the Open function button for each phase is no longer lit ■ LED next to the Close function button for each phase lights up red ■ Position indicator on the bottom of the recloser switch unit for each phase is red. 	
C.12	Select "Mode C: 1PTrip1Plo" from control and protection relay using the control mode	
C.13	Repeat C.03 through C.11 for phases A, B and C. Each phase will now operate independently.	
C.14	<p>Switch on miniature circuit breaker CB2:</p> <ul style="list-style-type: none"> ■ At external temperatures of < 95 °F (35 °C) the heaters heat up after approximately one minute. 	

Table 15: Final tasks

Item	Checklist	Notes
D.01	<p>Adjust the control and protection relay to the desired setting file:</p> <ul style="list-style-type: none"> ■ The control and protection relay shows default set in - Group 1 ■ If necessary, select other group with user-specific parameter settings. 	
D.02	If applicable, check the voltage and current readings of the controller.	
D.03	Check the date and the time on the controller and correct if necessary.	
D.04	Set trip counter to zero (at initial installation only).	
D.05	<p>Delete event memory (at initial installation only):</p> <ul style="list-style-type: none"> ■ If necessary, download events for further documentation. 	
D.06	Close and latch swing panel.	
D.07	Install controller cover and fasten.	
D.08	Close and secure triple-single type SDR controller door.	

Item	Checklist	Notes
E.01	Instruction manual available.	
E.02	Routine test records available.	
E.03	On-site instruction on recloser/controller.	
E.04	Order specific drawings are available.	
E.05	Type 7SR224 quick reference guide available.	

Table 16 Other services

Table 17: Remarks

Job	Name	Department	Date	Signature
Technician				
Commissioning engineer				
Owner				
Supervisor				
Instructed person				

Table 18: Signatures

Annex A

Vendor website information:

- Siemens type 7SR224 recloser control relay (standard control and protection relay option) <http://www.energy.siemens.com/us/en/power-distribution/reclosers/recloser-controller.htm>
- Schweitzer Engineering Laboratories, Inc. type SEL-651R recloser control relay (includes internal power module and capacitors which operate the switch unit magnetic actuator; type SDR switch unit driver electronics [PCB2] and capacitors [PCB3] are not utilized) <http://www.selinc.com/SEL-651R/>

The information provided in this document contains merely general descriptions or characteristics of performance which in case of actual use do not always apply as described or which may change as a result of further development of the products. An obligation to provide the respective characteristics shall only exist if expressly agreed in the terms of contract.

All product designations may be trademarks or product names of Siemens AG or supplier companies whose use by third parties for their own purposes could violate the rights of the owners..

Siemens Industry, Inc.
7000 Siemens Road
Wendell, NC 27591

For more information, contact:
+1 (800) 347-6659
www.usa.siemens.com/reclosers

Subject to change without
prior notice.
Order No.:
E50001-F710-A412-X-4A00
All rights reserved.
Printed in USA
© 2012 Siemens Industry, Inc.