

Switchboard (SB1, SB2, SB3)/ Power Panel Kit (P5) SJG2D for Branch Mounting Type VL JG Frame Breakers

Installation Instructions

10. Reference fig. 9 - Installing the provision barrier (item 19). In case of a provision, orient the barrier as shown in fig. 9. Insert the 5/16-18" screw (item 13) through the 0.312" hole in the barrier and through the 0.281" hole in the B-phase and tighten. Repeat this step if there is another provision.

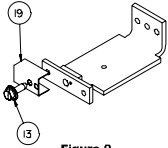

Figure 9

NOTE: If a Branch Neutral Lug Assembly is NOT Required, skip to Step 13.

NOTE: For switchboard applications, skip to Step 12.

11. Reference fig. 10 - Installing the Branch Neutral Lug (item 18) in a Panelboard. The Branch Neutral is located at the bottom of the "Z-rails", or mirrored at the top depending upon the feed cable location. Two (2) different Neutral lug assemblies are included in the kit, be sure to install the type pictured below. The Neutral lug assemblies can be mounted, as shown, on either side of the Branch Neutral depending on cable feed location. Torque all hardware as specified on the rear of the deadfront.

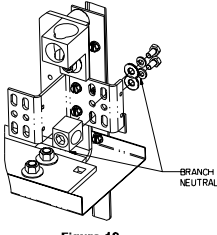

Figure 10
PANELBOARD ONLY

12. Reference fig. 11 - Installing the Branch neutral lug (item 18) in a Switchboard. The Branch Neutral is located at the bottom of the "Z-rails", or mirrored at the top depending upon the feed cable location. Two (2) different Neutral lug assemblies are included in the kit, be sure to install the type pictured below. The Neutral lug assemblies can be mounted, as shown, on any available hole of the Branch neutral depending on the cable feed location. Torque all hardware as specified on the rear of the deadfront.

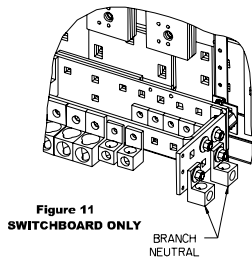

Figure 11
SWITCHBOARD ONLY

13. Re-install the deadfront using one of the breaker cover plates supplied with this kit. Other filler plates may be required for proper fit. See filler plate kits listed on the rear of the deadfront.

-4-

Installation Instructions

The following instructions are for the installation of Siemens VL JG Frame electronic trip breakers in switchboard (SB1, SB2, SB3) or deep panelboards (P5). This kit will require 6.25" of unit space. The parts provided in this kit are for connections to a 3-phase / 3-wire or 3-phase / 4-wire system.



HAZARDOUS VOLTAGE.
Will cause death or serious injury.
Keep out.
Qualified personnel only.
Disconnect and lock off all power before working on this equipment.

1. Lock off power supplying this equipment before working on it.
2. Reference fig. 1 - Remove the (2) gutter covers and all cover plates.

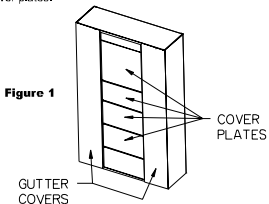

Figure 1

3. Reference fig. 2 - To mount a VL JG Frame breaker, 6.25" of empty unit space is required. To locate the mounting position, measure from the top deadfront support to the top of the empty unit space filler on the deadfront. Transfer this dimension from the deadfront support along the Z-rail and mark. This will be the unit space as shown on Fig. 4. After marking the Z-rail, remove the deadfront.

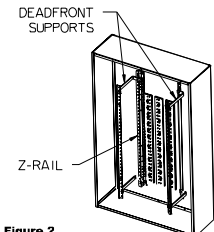

Figure 2

4. Open the shipping box and check the contents against the following list:

ITEM	DESCRIPTION	QTY.
1	INSTRUCTION MANUAL	1
2	A/C BOTTOM STRAP	2
3	A/C TOP STRAP	2
4	B PHASE STRAP	1
5	B PHASE LINK	1
6	BARRIER	1
7	CHRISTMAS TREE RIVET	1
8	BREAKER MOUNTING BRACKET	2
9	STRAP-SECTION BUS HARDWARE KIT	1
10	1/4-20 X 1/2" SCREW	4
11	1/4-20 X 3/8" SCREW	4
12	1/4-20 X 3/4" SCREW	2
13	5/16-18 X 1" SCREW	7
14	CARD HOLDER	2
15	CIRCUIT ID CARD	2
16	PACKAGING ASSEMBLY	1
17	6.25" COVER PLATE	1
18	NEUTRAL LUG ASSY.	2
19	PROVISION BARRIER	2

5. Reference fig 3 and fig 4 - The first items to be installed are the B strap and B-phase link (items 4 and item 5). Locate two 0.228" diameter holes on the B-phase of the section bus 5.00" down from the top of 6.25" unit space selected. Insert two 1/4-20 thread-forming screws (see the mounting hardware kit, item 9, for proper length) through the two holes in the B-phase strap (item 4) and then into the 0.228" diameter holes on the B-phase bus and tighten. To install the B-phase link (item 5), orient the link so that the half punch on the link is inserted into the 0.218 hole in the B-phase strap (item 4). Insert one 5/16-18" screw (item 13) through the 0.375" hole on B-phase link (item 5) and then into the 0.281" diameter hole on the B-phase strap and tighten. Torque all screws to the values specified on the rear of the deadfront.

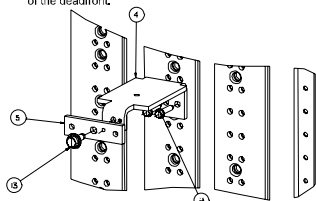

Figure 3

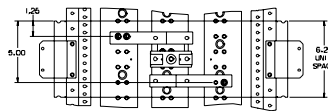

Figure 4

6. Reference fig. 5 - Attach the barrier (item 6) to B-phase strap. Insert the christmas tree rivet (item 7) through the 0.25" diameter hole in the barrier and into the 0.155" diameter hole in the B-phase strap. Push for a tight fit.

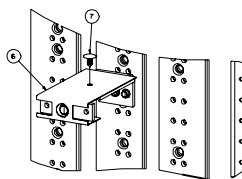

Figure 5

7. Reference fig. 4 and fig. 6 - Locate two 0.228" diameter holes in the A-phase section bus, 1-1/4" down from the top of 6.25" unit space selected. Insert two 1/4-20 thread-forming screws (see the mounting hardware kit, item 9, for proper length) through the two holes in the A-phase straps (item 2 and 3) and then into the 0.228" diameter holes on the A-phase bus and tighten. To install the C-phase strap (item 2 and 3) locate two 0.228" diameter holes on the C-phase section bus 5.00" down from the top of the 6.25" unit space. Insert two more 1/4-20 screws through the two holes in the strap and then into the 0.228" diameter holes in the C-phase section bus. Orient the straps as shown in fig. 6. Ensure that there is 1.75" vertically between centers of the straps. Torque all screws to the values specified on the rear of the deadfront.

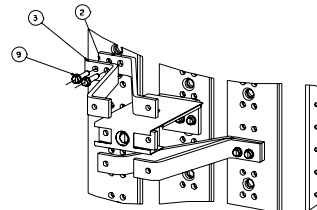

Figure 6

8. Reference fig. 7 - The mounting brackets (item 8) are to be mounted. Locate a 0.228" diameter hole on the left Z-rail 1.875" down from the top of the 6.25" of unit space. Insert one 1/4-20 X 3/8" screw (item 11) through the 0.312" diameter hole in the mounting bracket and then into the hole in the Z-rail and tighten securely. Orient the mounting bracket as shown. Insert another 1/4-20 X 3/8" screw through the second 0.312" diameter hole in the mounting bracket and then into a 0.228" diameter hole in the Z-rail and tighten securely. Repeat the same steps to install the second mounting bracket onto the right hand Z-rail.

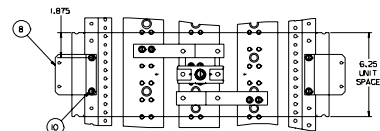

Figure 7

9. Reference fig. 8 - Install a circuit breaker by inserting one 5/16-18 screw (item 13) into each of the three contacts on the line side of the breaker and into the three 0.281" diameter holes in the phase straps. Insert two 1/4-20 X 3/4" screws (item 12) into the two 0.228" diameter holes in the mounting bracket and tighten securely. Torque the 5/16-18 screw connections to the values as specified on the rear of the deadfront.

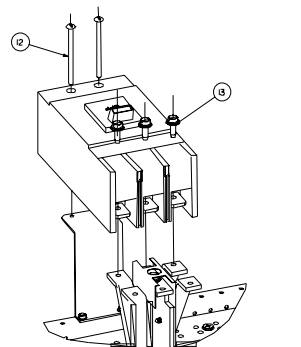

Figure 8

This device/system may only be set up and used in conjunction with these instructions. Installation, maintenance and operation of this device/system may only be performed by qualified personnel. Within the context of these instructions, qualified persons are defined as persons who have the skills and knowledge related to the construction and operation of the electrical equipment and installations and have received safety training to recognize and avoid the hazards involved.

11-B-1026-01 REV. 1

-2-

-3-

11-B-1026-01 REV. 1