

Catalog Number: MC2040B1200JLC

Features and Ratings

- UL Listed
- Pending XCEL Approval
- 200A Continuous Rating, Type HQ
Lever Bypass Meter Socket
- 20 Spaces, 40 Circuits Max.
- 200A Main Breaker Factory Installed
- 5th Jaw Factory Installed in 9 O'Clock Position

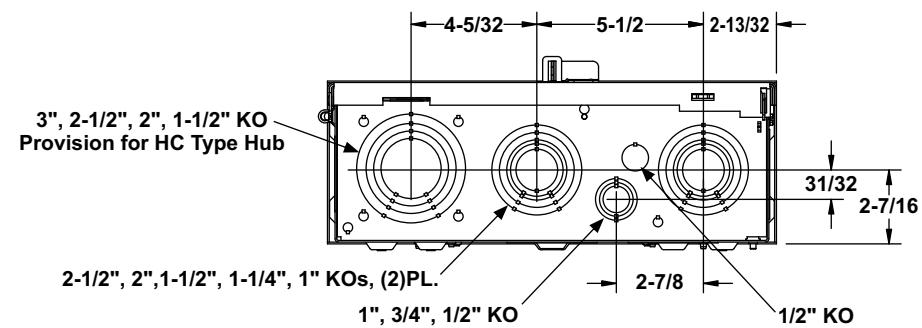
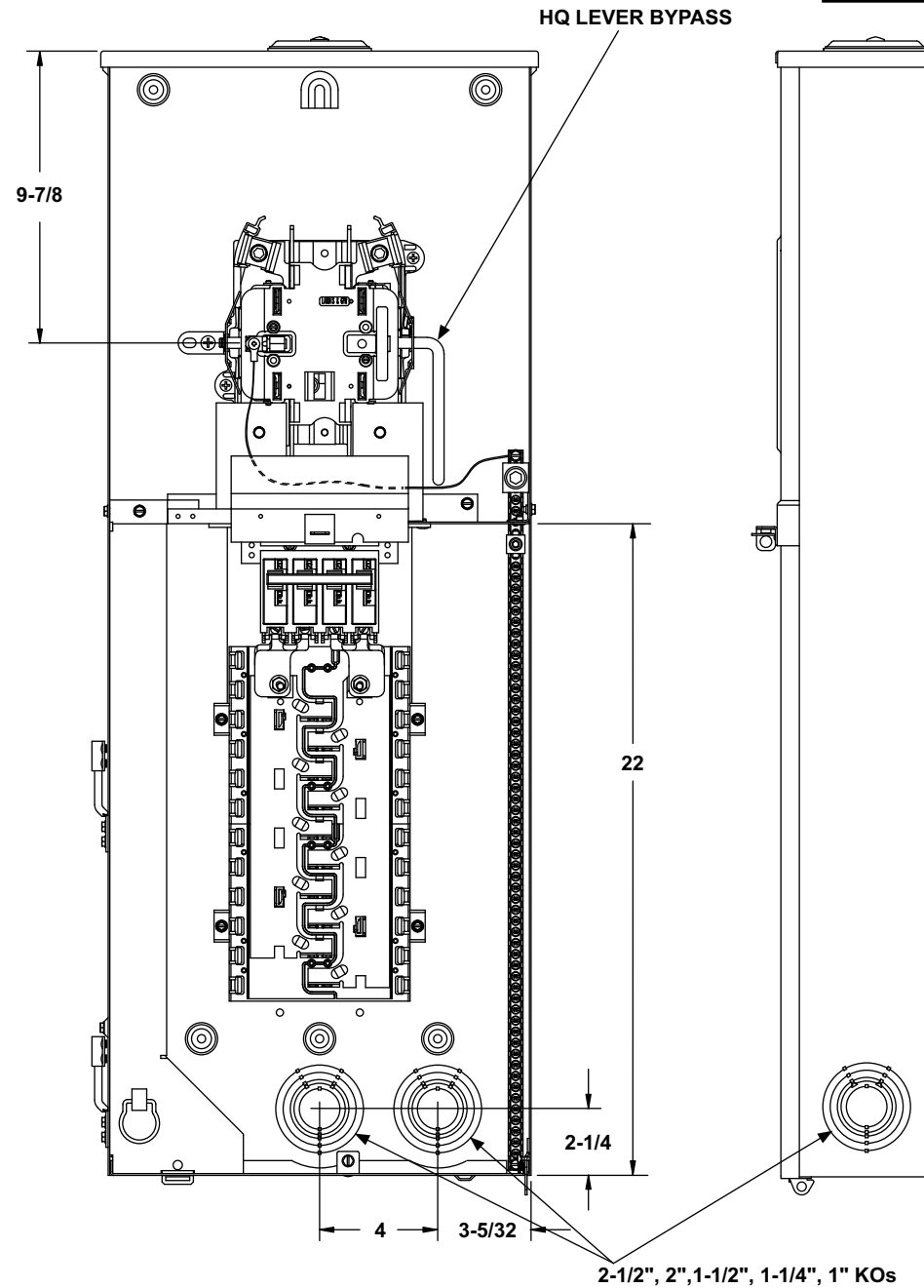
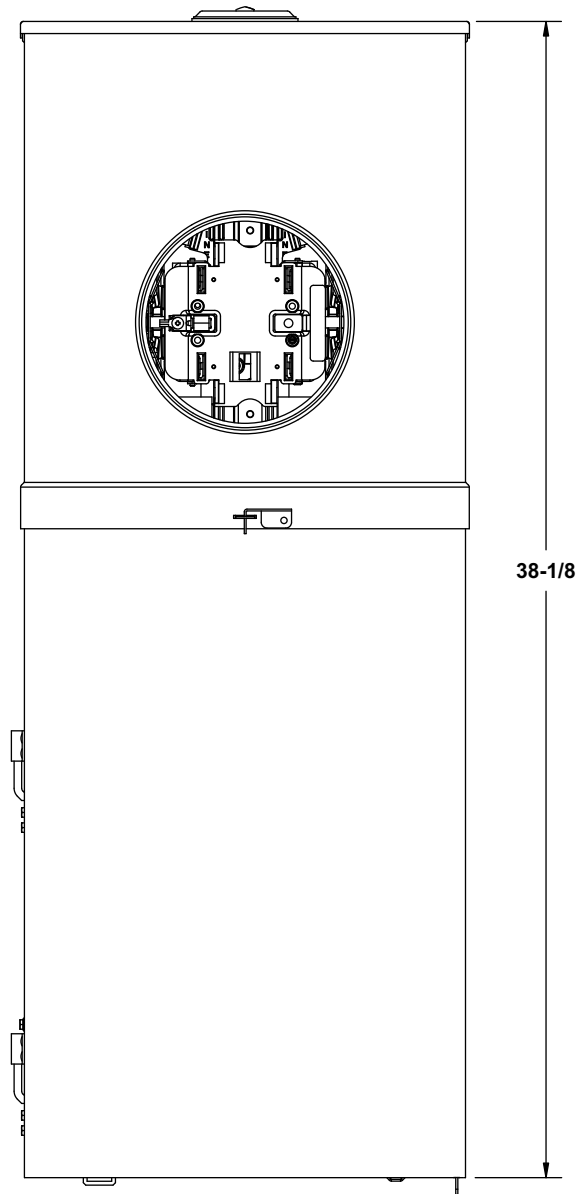
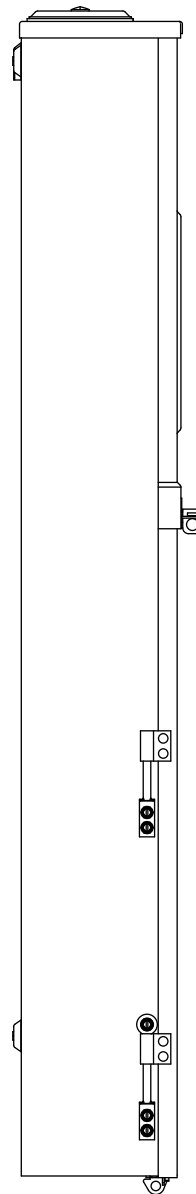
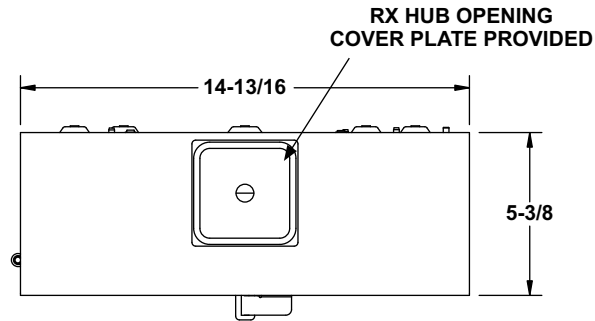

Accessories

Filler Plate Cat. No. QF3 or ECQF3
Mechanical Breaker Interlock: ECSBPK08
Equipment Grounding Bars: Type ECGB

Neutral Lug Kit	Wire Range	Torque
ECLK1-2	2/0-#4	45 Lb.-Ins.
ECLK2	2/0-#4	135 Lb.-Ins.
ECLK3	300 kcmil - #1	340 Lb.-Ins.

Trade size (in)	Catalog number
<i>RX Type Hub (top endwall)</i>	
1 1/4"	EC38597
1 1/2"	EC38598
2"	EC38599
2 1/2"	EC38600
<i>HC Type Hub (bottom endwall)</i>	
2"	EHC200
2 1/2"	EHC250
3"	EHC300

Wire Sizes and Torques

(see schematic)

Terminals A, B, and N
Suitable for 60°/75°C Conductors.
Wire Size: #4 AWG-250 kcmil.
A, B: Torque Terminals to 275 Lb.-Ins.
N: Torque Terminals to 250 Lb.-Ins.

Terminal N1 Wire Size: #4 - 2/0 AWG
Torque: 110 Lb.-Ins.

Neutral Bar is suitable for 60°/75°C Conductors.
Wire Size 4-14 AWG CU, 4-12 AWG AL.

Wire Size	Tighten Torque
14-10CU/12-10AL AWG	20 Lb.-Ins.
8 AWG	25 Lb.-Ins.
6-4 AWG	35 Lb.-Ins.

Schematic

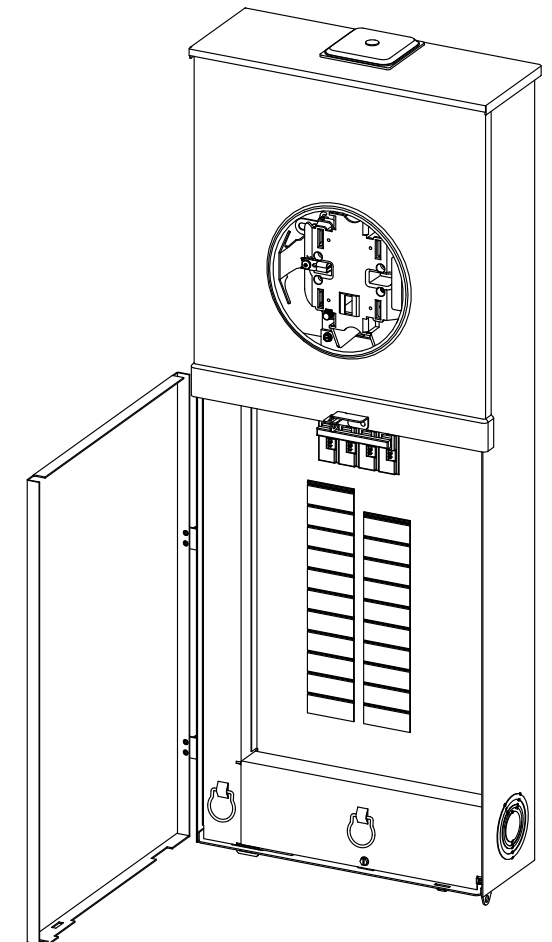
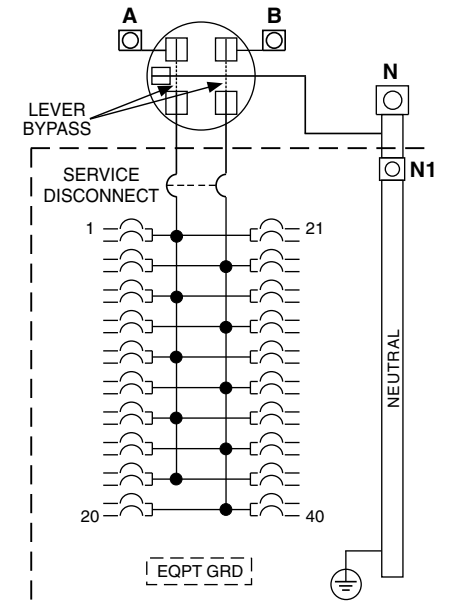

© 2010 Copyright Siemens Industry, Inc.

Siemens Industry, Inc.
Building Technologies Division

Meter Load Center Combination

Description:
200A 2040 HQ Lever Bypass OH/UG

Size B	FamT-LBP	Dwg. No.	MC2040B1200JLC	
Dwn	KAM	Date	5/10/10	DO NOT SCALE DRAWING SHEET 1 OF 1