

SIEMENS

Outdoor Uni-PAK All-In-One Metering

Catalog Number

WPL4412RJ

Enclosure

Type 3R

Main Bus Rating: 400 Amps
120/240 V~, 1 Phase, 3 Wire
208Y/120 V~, 1 Phase, 3 Wire

Meter Socket Rating: 200A Continuous
Branch Rating: Top breaker position: 200 Amps Max.
All other breaker positions: 225 Amps Max.

For installation by Qualified Person in accordance with all local electrical codes and/or the National Electrical Code ®.

Suitable Only For Use As Service Equipment. Install no more than six main disconnecting means.

For overhead or underground service.

Use 60/75°C Copper or Aluminum Conductors for all panel terminals and on circuit breaker terminals when breakers are so marked.

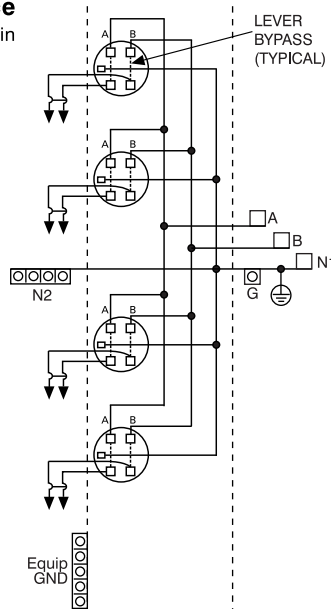

Terminal	Wire Size	Torque
A, B, N1	See Chart Below	
N2, G	300 kcmil - #4 AWG	275 LB-IN
Equip GND	#2/0 - 4 AWG	110 LB-IN
Lug Kit	Wire Size	Torque
H56476	800 kcmil - #3/0 AWG	500 LB-IN
H60162	600 kcmil - #4 AWG (2) 250 kcmil-#1/0 AWG	500 LB-IN
H68752-1	(3) 250 kcmil - #6 AWG	275 LB-IN
H56732	(2) 350 kcmil - #4 AWG	275 LB-IN
H56732M	(2) 500 kcmil - #4 AWG	375 LB-IN
Terminals A, B, N1: Torque 3/8-16 Nuts (9/16" drive) to 250 lb.-in.		

SIEMENS

Outdoor Uni-PAK All-In-One Metering

General Information:

Circuit breaker overload trip position is indicated by handle position midway between ON and OFF. To reset, move handle to OFF position, then turn ON.

Short Circuit Current Rating

The maximum short circuit current rating of this device is 100,000 RMS symmetrical amperes, 120/240 V~. The actual rating is limited to the lowest interrupting rating of any circuit breaker installed. Use only Siemens type QS, QSH, QSHH, HQS, HQSH, QP, QPH, HQP, HQPH, MP-T, MP-HT, or MP-MT circuit breakers. Use of other circuit breakers in this device will void the warranty.

Accessories

5th Jaw, 9 o'Clock Position S35815-2
Meter Socket Cover Plate (Ringless) ECCP3

Use HD Type Hubs if required

Trade Size (in)	Catalog No.
2"	EC56854
2-1/2"	EC56855
3"	EC56856
3-1/2"	EC56857
4"	EC56858
Closure Plate	EC56933S

Important: Do not allow petroleum based (hydrocarbon) sprays, chemicals, solvents or any paint to contact interior components. Petroleum based chemicals can cause degradation of electrical insulating materials.