



<b>5/2</b>	<b>Introduction</b>	<b>5/36</b>	<b>SIRIUS 3RR24 monitoring relays for mounting onto 3RT2 contactors for IO-Link</b>
5/2	Communication overview	5/36	General data
5/3	System components	5/39	Current and active current monitoring
5/8	IO-Link specification	<b>5/43</b>	<b>SIRIUS 3UG48 monitoring relays for stand-alone installation for IO-Link</b>
<b>5/9</b>	<b>Masters</b>	5/43	General data
5/9	IO-Link master module for S7-1200	5/46	Line monitoring
5/9	- SM 1278 4xIO-Link master	5/47	Voltage monitoring
5/10	IO-Link master module for ET 200SP	5/48	Current monitoring
5/10	- CM 4xIO-Link	5/49	Power factor and active current monitoring
5/12	IO-Link master modules for ET 200S		Residual current monitoring
5/12	- IO-Link 4SI electronic modules	5/50	- Residual-current monitoring relays
5/12	- SIRIUS 4SI electronic modules	5/51	- 3UL23 residual-current transformers
5/13	- SIRIUS 4SI electronic modules	5/52	Speed monitoring
5/14	IO-Link master modules for ET 200eco PN	5/53	Accessories
<b>5/15</b>	<b>Input modules</b>	<b>5/54</b>	<b>SIRIUS 3RS14, 3RS15 temperature monitoring relays for IO-Link</b>
5/15	General data	5/54	General data
5/16	IO-Link K20 modules	5/56	Relays, digitally adjustable for 1 sensor
<b>5/18</b>	<b>Contactors and contactor assemblies</b>	5/58	Relays, digitally adjustable for up to 3 sensors
5/18	SIRIUS 3RT20 contactors, 3-pole, 3 ... 18.5 kW	5/59	Accessories
5/20	SIRIUS 3RA23 reversing contactor assemblies	<b>5/60</b>	<b>RFID systems</b>
5/22	SIRIUS 3RA24 contactor assemblies for wye-delta starting	5/61	SIMATIC RF210R
5/24	SIRIUS 3RA27 function module for IO-Link	5/63	SIMATIC RF220R
<b>5/26</b>	<b>SIRIUS 3RB24 solid-state overload relays for IO-Link</b>	5/65	SIMATIC RF260R
5/26	3RB24 for IO-Link, up to 630 A for High-Feature applications		
5/30	Current measuring modules		
5/31	Accessories		
<b>5/33</b>	<b>SIRIUS 3RA6 compact starters</b>		
5/33	SIRIUS 3RA64, 3RA65 compact starters for IO-Link		
5/35	Accessories for compact starters for IO-Link		

# IO-Link

## Introduction

### Communication overview

#### Overview

IO-Link is an open communication standard for sensors and actuators – defined by the Profibus User Organization (PNO). IO-Link technology is based on the point-to-point connection of sensors and actuators to the control system.

Parameter and diagnostics data are transmitted in addition to the cyclic operating data for the connected sensors/actuators. The simple, unshielded three-wire cable customary for standard sensors is used for this purpose.

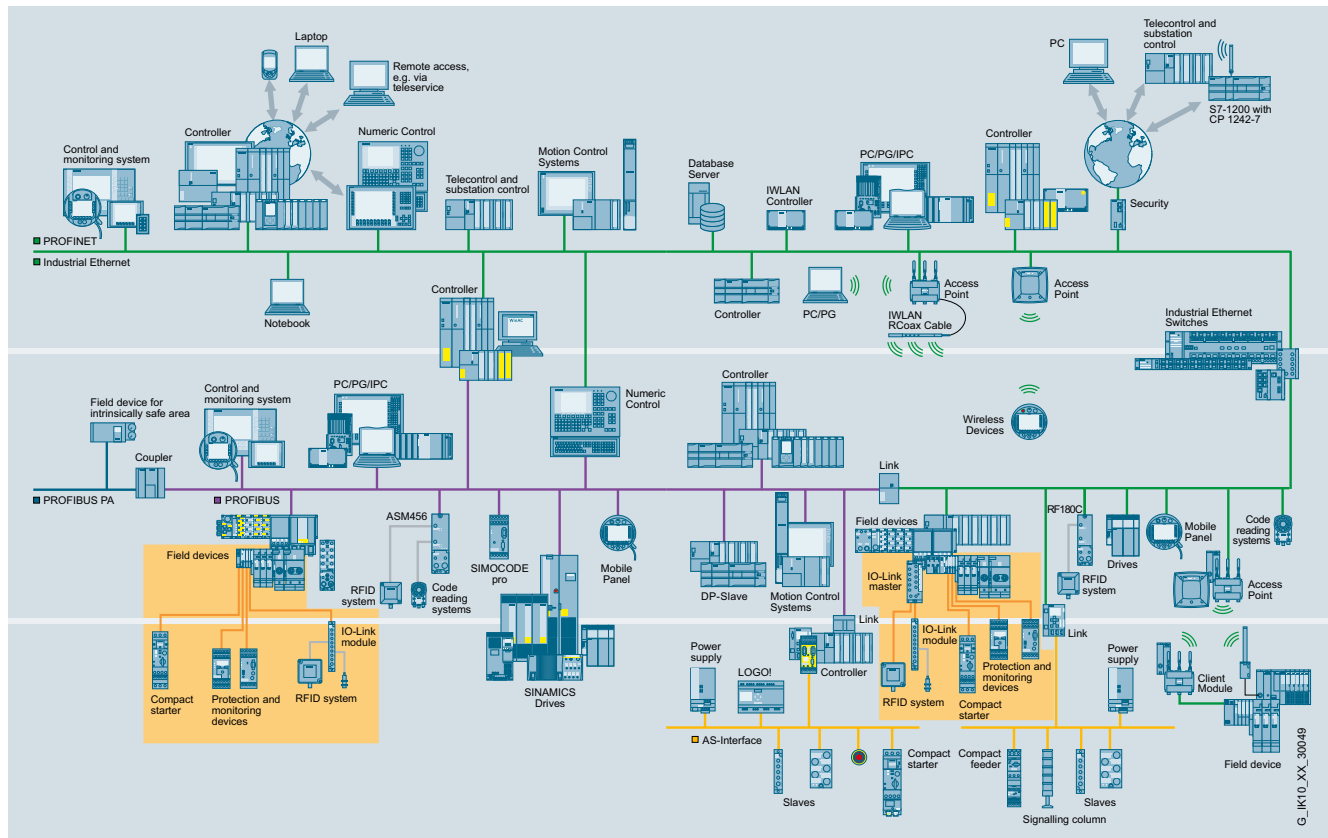

#### Benefits

##### Engineering

- Standardized, open system for greater flexibility (non-Siemens IO-Link devices can be integrated in engineering)
- Uniform, transparent configuring and programming through integrated engineering (SIMATIC STEP 7)
- Unassigned SIMATIC function blocks for easy parameterization, diagnostics and read-out of measured values
- Efficient engineering thanks to pre-integration into SIMATIC HMI
- Low error rate in CAD circuit diagram design as a result of reduced control current wiring

##### Installation and commissioning

- Faster assembly with minimized error rate as a result of reduced control current wiring
- Less space required in the control cabinet
- Low-cost circuitry where there are several feeders by making full use of existing components

##### Operation and maintenance

- High transparency in the system right down to field level and integration into power management systems
- Reduction in downtimes and maintenance times thanks to system-wide diagnostics and faster fault correction
- Support of predictive maintenance
- Shorter changeover times, even for field devices, by means of parameter and recipe management

#### Application

IO-Link can be used in the following main applications:

- Easy connection of complex IO-Link sensors/actuators with a large number of parameters and diagnostic data to the control system
- Replacement of sensor boxes for connecting binary sensors with the IO-Link input modules optimized in terms of cabling
- Optimized cable connection of switching devices to the control system
- Simple transmission of energy values from the device to the control system for integration into a user program or power management

In these cases, all the diagnostics data are transmitted to the higher-level control system through IO-Link. The parameter settings can be changed during operation. Central data storage means that it is possible to exchange an IO-Link sensor/actuator without a PC or programming device.

##### Integration in STEP 7

Integration of the device configuration in the STEP 7 environment guarantees:

- Quick and easy engineering
- Consistent data storage
- Quick localization and rectification of faults

### Overview



IO-Link product family

To implement communication, a system installation has the following main components:

- An IO-Link master
- One or more IO-Link devices, such as sensors (e.g. RFID systems), actuators or combinations thereof
- A standard 3-wire sensor/actuator cable

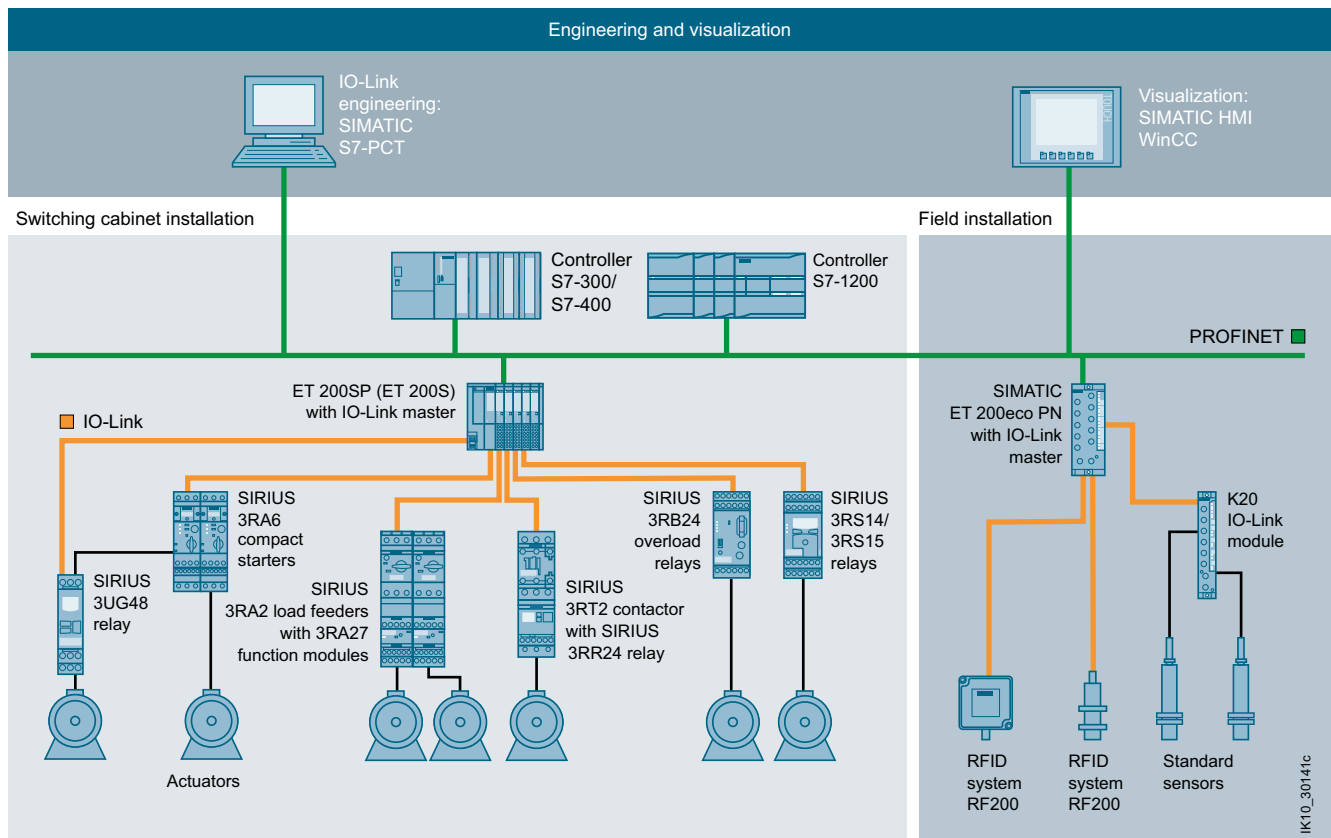

Example of a configuration with the system components

## IO-Link

### Introduction

#### System components

#### Overview (continued)

##### Compatibility of IO-Link

IO-Link guarantees compatibility between IO-Link-capable modules and standard modules as follows:

- IO-Link sensors can be operated both on IO-Link modules (masters) and standard input modules.
- IO-Link sensors/actuators as well as today's standard sensors/actuators can be used on IO-Link masters.
- If conventional components are used in the IO-Link system, then of course only the standard functions are available at this point.

##### Load feeders and motor starters

Through IO-Link it is possible to control not only sensors but also actuators in the form of load feeders and motor starters.

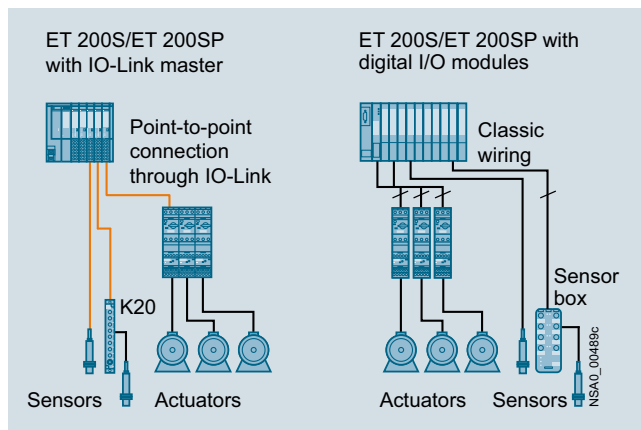

Possibilities for connecting load feeders and motor starters to IO-Link or in the conventional way

##### Analog signals

Another advantage of IO-Link technology is that analog signals are digitized already in the IO-Link sensor itself and are digitally transmitted by the IO-Link communication. As the result, faults are prevented and there is no extra cost for cable shielding.

##### Enhanced through IO-Link input modules

IO-Link compatibility also permits connection of standard sensors/actuators, i.e. conventional sensors/actuators can also be connected to IO-Link. This is particularly effective with the IO-Link input modules, which allow several sensors to be connected at one time via a cable to the controller.

##### Grouping of motor starters

The SIRIUS controls allow four starters to be combined to form a group.



Connection of a motor starter group made up of three 3RA64 direct-on-line starters and a 3RA65 reversing starter

In this way up to 16 starters can be operated on a single IO-Link master. This leads to a reduction in the installation space and control wiring required.

**Overview** (continued)**Monitoring relays**

By using monitoring relays with IO-Link it is now possible to send data that has already been recorded and evaluated in the devices directly to the controller. This avoids the use of duplicated sensors.

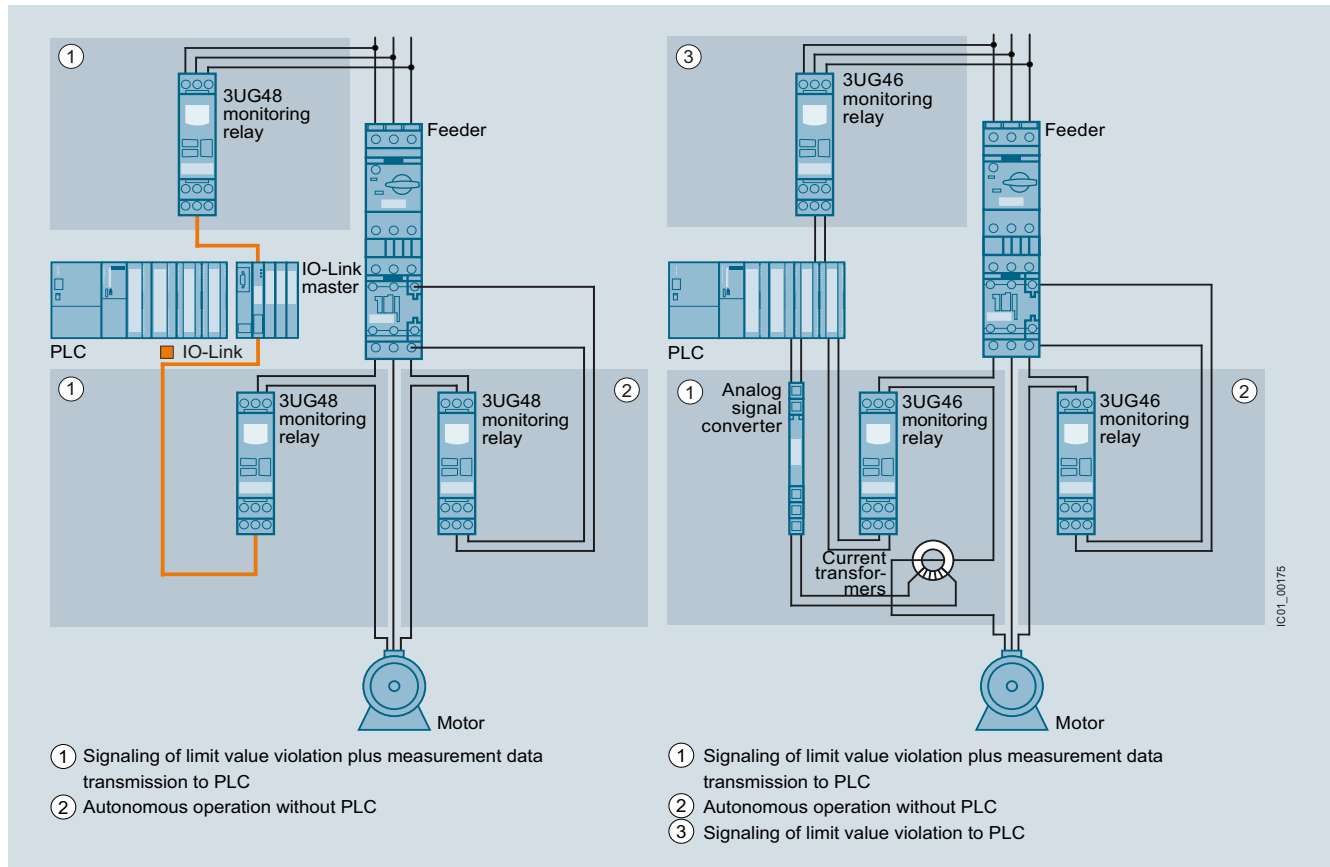

Possibilities for connecting monitoring relays to IO-Link or in the conventional way

## IO-Link

### Introduction

#### System components

#### Overview (continued)

##### Wireless communication

Using an upstream IWLAN client module, such as SCALANCE W722-1 RJ45, allows IO-Link to be integrated into the PROFINET world via a distributed I/O. Possible uses include acting as an alternative to fault-prone cable carrier or collector wire technology. The individual diagnostics options

offered by the various IO-Link devices provide greater transparency for the production process. Just like the parameter data for a device, these diagnostics data can be evaluated remotely using the possibilities offered by SIMATIC. This supports remote maintenance down to the lowest level in the field.

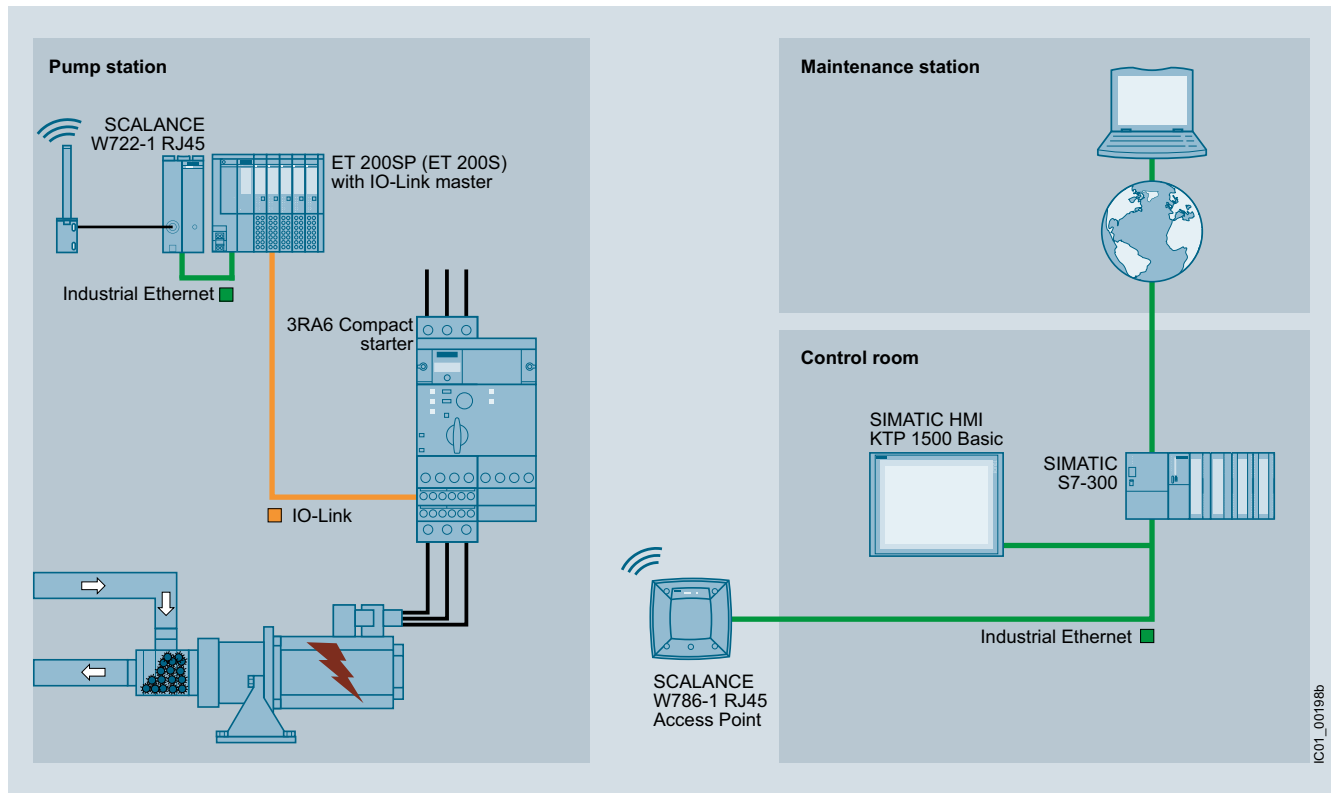

Wireless communication between Industrial Ethernet and IO-Link components

IC01\_00198b

## Overview (continued)

## IO-Link components

## IO-Link master, software, cables

CM 4xIO-Link  
for ET 200SP

STEP 7 PCT

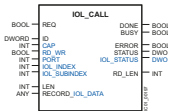
IO-Link Call  
function blockWinCC flexible  
template project

## Masters

IO-Link masters for S7-1200

- SM1278 4xIO-Link

See page 5/9

IO-Link master modules for ET 200SP

- CM 4xIO-Link

See page 5/10

IO-Link master modules for ET 200S

- IO-Link 4SI electronic modules
- SIRIUS 4SI electronic modules

see pages 5/13

IO-Link master modules for ET 200eco PN  
see page 5/14.

## Software

## STEP 7 PCT

Engineering software for configuring  
the IO-Link master modules for S7-1200,  
ET 200SP, ET 200S, ET 200eco

- Available as a stand-alone version or integrated into STEP 7 (V5.5 SP1 or later) and TIA (V12 or later)
- Retrieval of parameter and diagnostics data from the IO-Link devices connected to the master
- Monitoring of the process image of the IO-Link devices
- Open interface for importing further IO-DDS
- Freely available for download from Industry Online Support<sup>1)</sup>

## IO-Link Call function block

STEP 7 function block for easy acyclical data  
exchange in the user program

- Freely available for download from Industry Online Support<sup>2)</sup>

## WinCC flexible template project

Easy integration of IO-Link devices into the  
user program by using ready-made WinCC  
flexible templates

- Freely available for download from Industry Online Support<sup>3)</sup>

## IODD files

IO-Link Device Description (IODD) files  
provide the device description for IO-Link

- Comprehensive IODD catalog of SIEMENS IO-Link devices
- Freely available for download from Industry Online Support<sup>4)</sup>

## Cable

3-wire standard cable

see for example catalog ID 10 "Industrial  
Identification Systems"

## IO-Link devices



K20 input module

## Detection with IO-Link

## IO-Link input modules

K20 input module

- 4 inputs, M12 connections
- 8 inputs, standard M8 connections

See page 5/15

## IO-Link devices (continued)

SIMATIC RF210R,  
SIMATIC RF220R,  
SIMATIC RF260R

## IO-Link RFID systems

SIMATIC RF200 RFID system in the HF range

- SIMATIC RF210R, SIMATIC RF220R, SIMATIC RF260R products
- Simple identification tasks (read-only), such as reading an ID number
- No RFID-specific programming, ideal for those new to RFID
- Simple connection via master modules for IO-Link, such as SIMATIC ET 200S and ET 200eco
- Use with the tried and tested ISO 15693 transponders (MOBY D)  
see Catalog ID 10 "Industrial Identification Systems"

## Switching with IO-Link

## Contactors and contactor assemblies

Power contactors for switching motors

- SIRIUS 3RT2 contactors, 3-pole, up to 18.5 kW

See page 5/18

Contactor assemblies

- SIRIUS 3RA23 reversing contactor assemblies
- SIRIUS 3RA24 contactor assemblies for wye-delta starting

See page 5/22

SIRIUS 3RA27 function modules for IO-Link

- For direct-on-line starters, reversing starters and wye-delta starters

See page 5/24

## Motor starters for use in the control cabinet

SIRIUS 3RA6 compact starters

- 3RA64 direct-on-line starters
- 3RA65 reversing starters
- Infeed system for 3RA6

see page 5/33

SIRIUS 3RA2711  
function module for IO-LinkSIRIUS 3RA64  
direct-on-line starterSIRIUS 3RB24  
overload relaySIRIUS 3RR24  
monitoring relaySIRIUS 3UG48  
monitoring relaySIRIUS 3RS14  
temperature monitoring relay

## Contactors with IO-Link

## Overload relays

SIRIUS 3RB24 solid-state overload relays for  
IO-Link

- Evaluation module
- Current measuring modules from 0.3 to 630 A
- Controlling direct-on-line, reversing and star-delta starters via IO-Link in conjunction with contactors
- Full motor protection
- Diagnostics and current value transmission via IO-Link

See page 5/26

## Monitoring with IO-Link

## SIRIUS 3RR24 monitoring relays for IO-Link

- Monitoring of current, phase failure, open circuit and phase sequence
- Designed for mounting on 3RT2 contactors

See page 5/36

## SIRIUS 3UG48 monitoring relays for IO-Link

- Monitoring network, voltage, current, cos  $\varphi$ , residual current or speed depending on device design
- On/tripping delay time can be adjusted

See page 5/43

## SIRIUS 3RS14, 3RS15 temperature monitoring relays for IO-Link

- Temperature monitoring with connected sensors
- Two limit values, can be adjusted separately

See page 5/54

1) <http://support.automation.siemens.com/WWW/view/en/37936752>2) <http://support.automation.siemens.com/WWW/view/en/82981502>3) <http://support.automation.siemens.com/WWW/view/en/38006560>4) <http://support.automation.siemens.com/WWW/view/en/29801139/133100>



# IO-Link

## Introduction

### IO-Link specification

#### Overview

##### Principles of the IO-Link specification

According to the IO-Link specification, communication functions as follows:

- Transmission takes place via an unshielded three-wire cable no more than 20 m long, of the kind normally used for standard sensors.
- Analog values which have already been digitized are transmitted in the form of message frames, which may correspond to  $\pm 10$  V or 4 to 20 mA.
- Digital communication from 0 to 24 V on the so-called C/Q cable
- Most of the values transmitted are measured values from the sensors which include the units.
- The sensors and actuators are described by the IO-Link Device Description (IODD).
- While the IO-Link specification permits an infinite number of ports, an IO-Link master currently only supports four ports. Only one IO-Link device (slave) can be connected to each port (point-to-point connection).
- The transmission rates between IO-Link master and the devices are as follows:
  - via COM1: 4 800 Bd
  - via COM2: 38 400 Bd
  - via COM3: 230 400 Bd
- The average cycle time is 2 ms for the reading/writing of 16 data bits at a transmission rate of 38 400 Bd.

##### IO-Link protocol

For the dialog between device and master, IO-Link uses a standard protocol, the standard asynchronous communication interface (UART) in "semi-duplex" mode.

The IO-Link protocol supports both the Standard IO mode (SIO) and the IO-Link communication mode (COM).

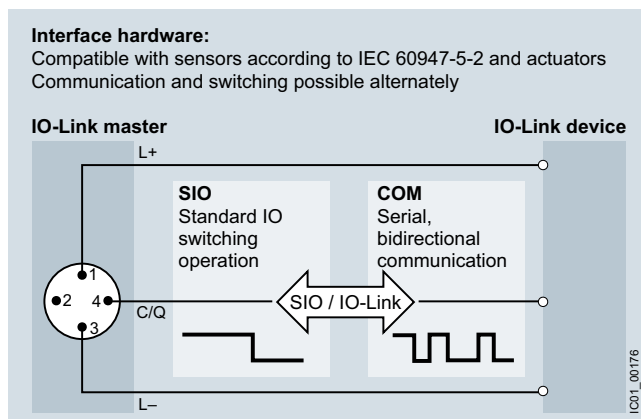

The structure of the protocol and its message frames depends on the types of data to be transmitted.

##### Data types

In the IO-Link specification a distinction is made between the following data types:

###### Process data

The process data of the devices are transmitted cyclically in a data frame, provided the process data width does not exceed 2 bytes. In the case of larger process data widths up to 32 bytes, parts are transmitted one after the other in several cycles. As of Version 1.1 of the specification, up to 32 bytes of process data can be transferred in a single cycle.

###### Service data (SD)

With the aid of the service data, parameter values or device statuses can be read out. It is also possible to write the parameter values or transmit commands via the service data. Service data are always exchanged acyclically and in response to an inquiry from the IO-Link master.

###### Events

Via events it is possible to transmit device events or statuses such as contamination, overheating, short circuits etc., from the device via the IO-Link master to the PLC or to visualize them.

The events are sent on the initiative of the devices via the "event flag", which the master evaluates. The master itself can also generate events.

Three categories of event are defined:

- Error signals (errors)
- Maintenance data (warnings)
- Device functions (notifications)

###### Data storage

As of Specification V1.1, a data storage concept has been created for IO-Link. In this concept, the IO-Link device initiates the storage of its data on a higher-level parameter server. In the event that a device is replaced, the parameter server can restore the original parameterization. It is therefore possible to replace the devices without re-parameterization.

The IO-Link master can contain the parameter server.

The parameter server can also be implemented centrally in the PLC or in a system server. In this case the IO-Link master passes on the corresponding information.

###### IO-Link master

The IO-Link master is the interface to higher-level control systems. The IO-Link master presents itself as a normal fieldbus node, and is integrated into the appropriate network configurator via the relevant device description (e. g. GSD, FDCML, EDS etc.).

###### IO-Link Device Description (IODD)

The IO-Link Device Description (IODD) has been defined to provide a full, transparent description of system characteristics as far as the IO-Link device. It is based on the open XML standard.

The IODD contains information on communication characteristics, device parameters, identification, process and diagnostics data, and is supplied by the manufacturer. The design of the IODD is the same for all devices from all manufacturers, and is always presented in the same way by the IODD Interpreter Tools. This therefore ensures that the handling is the same for all IO-Link devices, whatever the manufacturer.

###### New in IO-Link Specification V1.1

The IO-Link Specification is currently available in Version 1.1, and standardized in accordance with IEC 61131-9.

Specification V1.1 offers the following new features compared with the previous Specification V1.0:

- Transmission of up to 32 bytes of process or service data in one cycle
- Data storage concept



### Overview



SM 1278 4xIO-Link master

The SM 1278 4xIO-Link master signal module is an IO-Link master, and can be used in the SIMATIC S7-1200 automation system.

#### Features

- IO-Link master according to IO-Link specification V1.1
- Up to four IO-Link devices (3-wire connections) can be connected to each IO-Link master module.
- Data transmission rates COM1 (4.8 kBd), COM2 (38.4 kBd), COM3 (230.4 kBd), automatic adjustment to the transmission rate supported by the device
- Port-by-port parameterizable diagnostics
- Up to eight IO-Link master modules can be used depending on the SIMATIC S7-1200 CPU in use.

#### Central data storage

The device parameters are kept in the master module according to the specification V1.1.

#### Note:

When the SM 1278 4xIO-Link master module is exchanged, the IO-Link parameter data are not assigned automatically.

### Configuration

#### Module integration

To integrate the module you need the STEP 7 V13 TIA Portal engineering tool.

#### Configuration

S7-PCT V3.2 and higher is required in addition for IO-Link configuration.

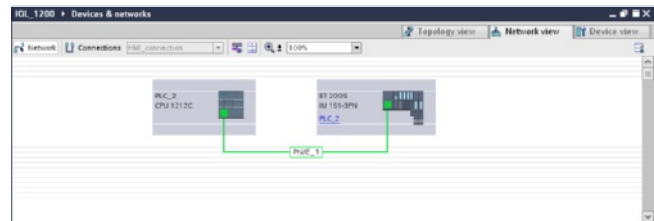

PROFINET configuration with SIMATIC S7-1200 CPU and ET 200S distributed I/O with IO-Link master modules

The address areas for exchanging the cyclic data (process values) are defined by IO-Link in the device view of the PROFINET device.

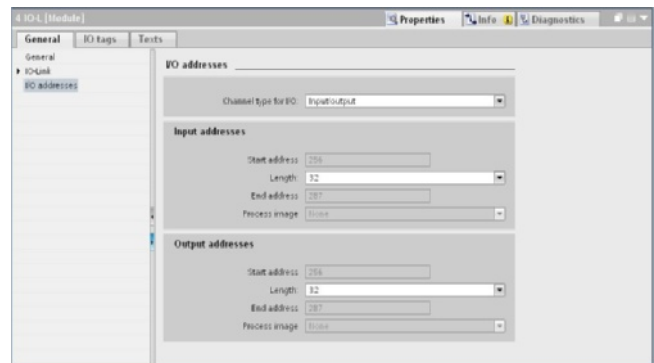

Device view with setting of the address range by IO-Link via TIA Portal

### Selection and ordering data

Version	Article No.
 <p><b>SM 1278 4xIO-Link master signal modules</b></p> <ul style="list-style-type: none"> <li>• IO-Link master for SIMATIC S7-1200</li> <li>• Corresponds to IO-Link specification V1.1</li> <li>• Dimensions (W x H x D / mm): 45 x 100 x 75</li> <li>• Up to eight IO-Link master modules can be used depending on the SIMATIC S7-1200 CPU in use.</li> <li>• Firmware updates</li> </ul>	<b>6ES7278-4BD32-0XB0</b>

6ES7278-4BD32-0XB0

### More information

For more information about SIMATIC S7-1200 see <http://support.automation.siemens.com/WW/view/en/86567043>.

#### Manuals

Manual "SIMATIC IO-Link System" see <http://support.automation.siemens.com/WW/view/en/65949252>.

### Industry Mall

More information see Industry Mall at "Automation Technology" ⇒ "Industrial Communication" ⇒ "IO-Link" ⇒ "Masters" ⇒ "IO-Link Master Module for S7-1200"

## IO-Link

### Masters

#### IO-Link master module for ET 200SP

#### CM 4xIO-Link

#### Overview



IO-Link master CM 4xIO-Link

The CM 4xIO-Link communication module is the IO-Link master, for use in the ET 200SP distributed I/O system.

#### Features

- IO-Link master as serial communication module with 4 ports according to IO-Link specification V1.1
- Module exchange with automatic data recovery without engineering for IO-Link master and IO-Link device
- Up to four IO-Link devices (3-wire connections) can be connected to each IO-Link master module.
- Data transmission rates COM1 (4.8 kBd), COM2 (38.4 kBd), COM3 (230.4 kBd), automatic adjustment to the transmission rate supported by the device
- Port-by-port parameterizable diagnostics
- PROFinergy support
- Parameterization of IO-Link parameters by S7-PCT V3.0 and higher

#### Central data storage

If the communication module is pulled off the BaseUnit, part of the electronic coding element will remain in the BaseUnit. Stored in this part are the parameters of the CM 4xIO-Link and the parameters of the IO-Link devices. When a new (not yet parameterized) IO-Link master is plugged on, it will adopt the parameters from the electronic coding element.

#### Connection

All type A0 BaseUnits can be used for the CM 4xIO-Link communication module, i.e. all variants of the BaseUnit (without/with infeed, -AUX).

#### Configuration

##### Module integration

To integrate the module you need the engineering tool STEP 7 V5.5 and higher or STEP 7 V11 TIA Portal.

##### Configuration

S7-PCT V3.0 and higher is required in addition for IO-Link configuration.

The following diagram shows a PROFINET configuration in which PROFINET ET 200SP and ET 200eco PN devices are integrated with IO-Link masters.



Configuration of a PROFINET network with lower-level IO-Link masters

The address areas for exchanging the cyclic data (process values) are defined by IO-Link in the device view of the PROFINET device.

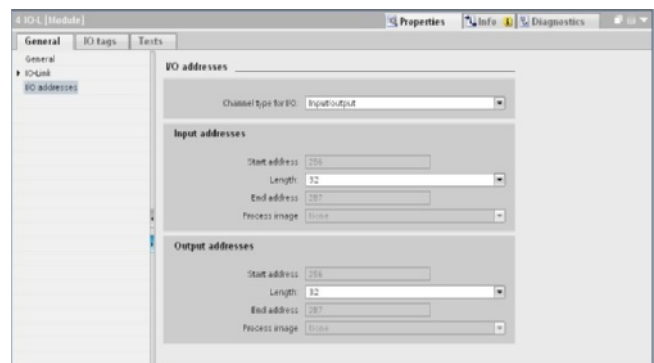

Device view with setting of the address range by IO-Link via TIA Portal

### Selection and ordering data

Version	Article No.
 <p><b>CM 4xIO-Link communication modules</b></p> <ul style="list-style-type: none"> <li>• IO-Link master for SIMATIC ET 200SP, can be plugged onto BaseUnit</li> <li>• Corresponds to IO-Link specification V1.1</li> <li>• Dimensions (W × H × D / mm): 15 × 100 × 75</li> </ul>	<p><b>6ES7137-6BD00-0BA0</b></p>

6ES7137-6BD00-0BA0

### Accessories

Version	Article No.
 <p><b>BaseUnit</b></p> <ul style="list-style-type: none"> <li>• BaseUnit BU15-P16+A10+2D for CM 4xIO-Link to SIMATIC ET 200SP</li> <li>• For opening a new voltage group via the plugged-in peripheral module</li> <li>• Current carrying capacity per process terminal max. 2 A</li> </ul>	<p><b>6ES7193-6BP20-0DA0</b></p>

6ES7193-6BP20-0DA0

### More information

#### Manuals

Manual "SIMATIC IO-Link System" see  
<http://support.automation.siemens.com/WW/view/en/65949252>.

System manual "ET 200SP Distributed I/O System" see  
<http://support.automation.siemens.com/WW/view/en/58649293>.

Product manual "SIMATIC ET 200SP Communication Module  
 IO-Link Master CM 4xIO-Link" see  
<http://support.automation.siemens.com/WW/view/en/67328527>.

#### Industry Mall

For more information see Industry Mall at  
 "Automation Technology" ⇒ "Industrial Communication"  
 ⇒ "IO-Link" ⇒ "Masters" ⇒ "IO-Link Master Module for ET 200SP".

## IO-Link

### Masters

### IO-Link master modules for ET 200S

#### 4SI IO-Link electronic modules

#### Overview



IO-Link 4SI electronic module for ET 200S

The 4SI IO-Link electronic module is an IO-Link master and enables easy integration of sensors and actuators from different manufacturers in the SIMATIC ET 200S multifunctional, distributed I/O system at a total of four ports.

#### Features



- Up to four IO-Link devices (3-wire connection) can be connected to each IO-Link master module. 3RA6 compact starters or load feeders with 3RA27 function modules can even be bundled in groups of four devices on one IO-Link port. It is possible therefore to connect up to 16 load feeders to the control system at one IO-Link master module.
- Up to four standard sensors (2-wire/3-wire connection) can be connected.
- The 4SI IO-Link electronic module has a width of 15 mm and can be used with the following universal terminal modules:
  - TM-E15S26-A1 (screw terminals)
  - TM-E15C26-A1 (spring-type terminals)
  - TM-E15N26-A1 (FastConnect)
- Supports firmware update (STEP 7 V5.4 SP4 and higher).
- Corresponds to IO-Link Specification V1.0

#### Selection and ordering data

Version	Connection	Article No.
 <b>IO-Link 4SI electronic module</b>	Screw terminals, spring-type terminals or FastConnect, depending on universal terminal module	<b>6ES7138-4GA50-0AB0</b>

6ES7138-4GA50-0AB0

#### Accessories

Version	Connection	Article No.
<b>Universal terminal modules for ET 200S</b>		
Module type		
• TM-E15S26-A1	Screw terminals	 <b>6ES7193-4CA40-0AA0</b>
• TM-E15C26-A1	Spring-type terminals	 <b>6ES7193-4CA50-0AA0</b>
• TM-E15N26-A1	FastConnect	 <b>6ES7193-4CA80-0AA0</b>

#### More information

##### Manuals

Product manual "SIMATIC ET 200S distributed I/O 4SI IO-Link electronic modules" see  
<http://support.automation.siemens.com/WW/view/en/29825814>

##### Industry Mall

More information and technical specifications see Industry Mall under "Automation"  
 ⇒ "Industrial Communication" ⇒ "IO-Link" ⇒ "Masters"  
 ⇒ "IO-Link Master Modules for ET 200S".

## Overview



SIRIUS 4SI electronic module for ET 200S

The SIRIUS 4SI electronic module allows the simple and cost-effective connection of SIRIUS devices with IO-Link to the multi-functional, distributed I/O system SIMATIC ET 200S at a total of four ports.

### Features



- Up to 4 SIRIUS devices can be connected at the 4 ports of the SIRIUS 4SI electronic module. 3RA6 compact starters or load feeders with 3RA27 function modules can even be bundled in groups of four devices on one IO-Link port. It is possible therefore to connect up to 16 load feeders to the control system at one IO-Link master module.
- The SIRIUS 4SI electronic module has a width of 15 mm and can be used with the following universal terminal modules:
  - TM-E15S26-A1 (screw terminals)
  - TM-E15C26-A1 (spring-type terminals)
  - TM-E15N26-A1 (FastConnect)
- Supports firmware update (STEP 7 V5.4 SP5 and higher)
- Corresponds to IO-Link Specification V1.0

## Selection and ordering data

Version	Connection	Article No.
 <b>SIRIUS 4SI electronic modules</b>	Screw terminals, spring-type terminals or FastConnect, depending on universal terminal module	<b>3RK1005-0LB00-0AA0</b>

3RK1005-00LB00-0AA00

## Accessories

Version	Connection	Article No.
<b>Universal terminal modules for ET 200S</b>		
Module type		
• TM-E15S26-A1	Screw terminals	 <b>6ES7193-4CA40-0AA0</b>
• TM-E15C26-A1	Spring-type terminals	 <b>6ES7193-4CA50-0AA0</b>
• TM-E15N26-A1	FastConnect	 <b>6ES7193-4CA80-0AA0</b>

## More information

### Manuals

Product manual "ET 200S distributed I/O system - 4SI SIRIUS electronic modules" see <http://support.automation.siemens.com/WW/view/en/37856470>.

### Industry Mall

More information and technical specifications see Industry Mall under "Automation" ⇒ "Industrial Communication" ⇒ "IO-Link" ⇒ "Masters" ⇒ "IO-Link Master Modules for ET 200S".

## IO-Link Masters

### IO-Link master modules for ET 200eco PN

#### Overview



IO-Link master module for ET 200eco PN

The ET 200eco PN IO-Link master module is an IO-Link master and enables easy connection of sensors and actuators from different manufacturers to the I/Os directly in the machine's field area.

#### Features

- Up to four IO-Link devices (3-wire connection) can be connected to each IO-Link master module.
- Up to eight standard sensors (8 DI) and up to four standard actuators (4 DO) can be connected in addition.

#### Selection and ordering data

	Version	Connection	Article No.
	<b>IO-Link master modules for ET 200eco PN</b> Block I/Os in IP65	M12	<b>6ES7148-6JA00-0AB0</b>

6ES7148-6JA00-0AB0

#### More information

##### Manuals

Manual "SIMATIC Distributed I/O ET 200eco PN" see <http://support.automation.siemens.com/WW/view/en/29999018>

##### Industry Mall

More information and technical specifications see Industry Mall under "Automation"  
⇒ "Industrial Communication" ⇒ "IO-Link" ⇒ "Masters"  
⇒ "IO-Link Master Modules for ET 200eco PN".



## Overview



IO-Link input modules

Using IO-Link technology, it is basically possible to connect standard sensors to IO-Link masters. However, connecting standard sensors directly to the IO-Link master does not exploit the full potential of IO-Link. The solution lies in the technology of the IO-Link modules. Their use is a more economically attractive solution in comparison with the direct connection of a sensor.

IO-Link input modules are a sensible addition to the ET 200S distributed peripherals. The IO-Link input module technology enhances IO-Link via a pure point-to-point cable connection towards decentralized structures. The maximum cable length of an IO-Link connection between an IO-Link module and an IO-Link master is 20 m. The use of sensor boxes with accordingly complex and error-prone wiring is no longer necessary.

**Transmission of parameter and diagnostic signals**

The IO-Link input modules also offer the possibility of transmitting parameters and diagnostic signals. This enables for example the inputs of modules to be parameterized as NC contacts or NO contacts through IO-Link. An overload or short circuit in the sensor supply is signaled to the control system through the IO-Link master.

**M8 and M12 terminals**

M8 and M12 terminals are available for connecting the sensors. Connection to the IO-Link master is made using a standard M12 connecting cable.

## Benefits

The use of IO-Link input modules has the following benefits:

- Economical use of innovative IO-Link technology also for binary sensors
- Optimum use of all ports of the IO-Link master
- Connection of several binary sensors/actuators to one port of the IO-Link master, hence low-cost connection of also binary sensors/actuators to the control system through IO-Link
- Reduction of digital input modules in the peripheral station
- Use of parameters also for binary sensors (e. g. NC contacts, NO contacts and input delay can be parameterized)
- Reduction of cabling and hence less risk of wiring errors by dispensing with sensor boxes
- Expansion toward distributed structures using pure point-to-point wiring
- Easy and elegant integration of sensors within a radius of 20 m around an ET 200S station
- Possibility of transmitting parameter and diagnostic signals (e.g. sensor supply overload)
- Can also be used in harsh ambient conditions thanks to the very compact design and degree of protection IP67

## Application

IO-Link input modules are particularly used where sensor boxes had previously been used for the connection of binary sensors.

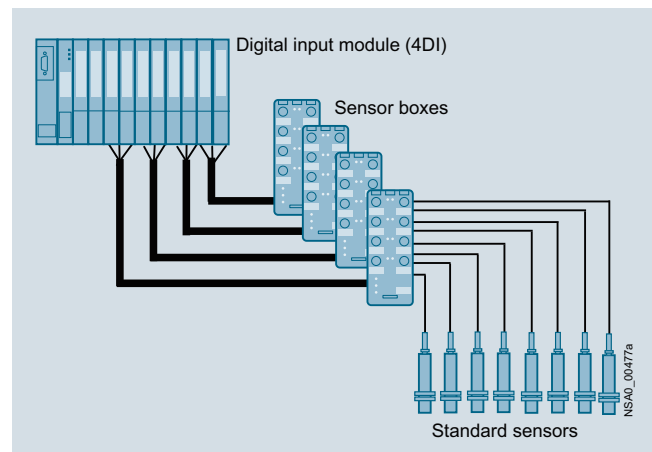

Former technology with sensor boxes

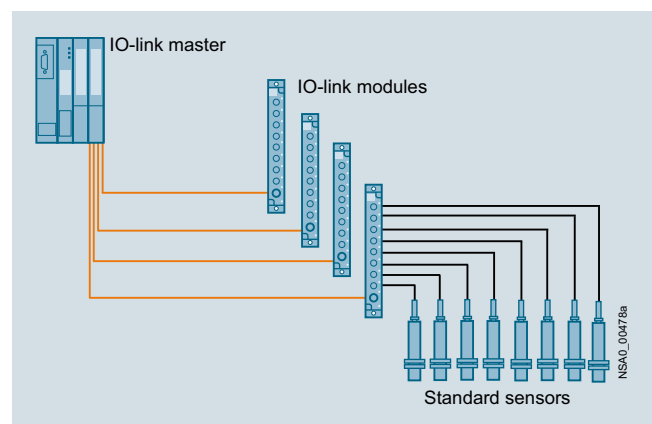



Technology with IO-Link input modules

**IO-Link**

## Input modules

**IO-Link K20 modules****Selection and ordering data**

	Type	Pin assignment	Connection	Article No.
 3RK5010-0BA10-0AA0	<b>IO-Link K20 modules</b> • 4 inputs • 8 inputs	Y	M12	<b>3RK5010-0BA10-0AA0</b> <b>3RK5010-0CA00-0AA0</b>
		Standard	M8	
 3RK5010-0CA00-0AA0				

## Accessories

	Type	Article No.
 3RK1901-1KA00	<b>M12 sealing caps</b> For free M12 sockets	<b>3RK1901-1KA00</b>
 3RK1901-1PN00	<b>M8 sealing caps</b> For free M8 sockets	<b>3RK1901-1PN00</b>
 3RK1902-4GB50-4AA0	<b>Control cables, assembled at one end</b> Angular M12 socket for screw fixing, 4-pole, 4 x 0.34 mm <sup>2</sup> , A-coded, black PUR sheath, max. 4 A • Cable length 5 m	<b>3RK1902-4GB50-4AA0</b>
 3RK1902-4CA00-4AA0	<b>Angular M12 socket</b> for screw fixing, 4-pole screw terminals, max. 0.75 mm <sup>2</sup> , A-coded, max. 4 A	<b>3RK1902-4CA00-4AA0</b>
 3RK1902-4BA00-5AA0	<b>M12 plugs, straight</b> For screw fixing, 5-pole screw terminals, max. 0.75 mm <sup>2</sup> , A-coded, max. 4 A	<b>3RK1902-4BA00-5AA0</b>
 3RK1902-4DA00-5AA0	<b>M12 plugs, angled</b> For screw fixing, 5-pole screw terminals, max. 0.75 mm <sup>2</sup> , A-coded, max. 4 A	<b>3RK1902-4DA00-5AA0</b>
 3RK1902-4H...-5AA0	<b>Control cables, assembled at one end</b> M12 plugs, angled, for screw fixing, 5-pole, 5 x 0.34 mm <sup>2</sup> , A-coded, black PUR sheath, max. 4 A • Cable length 1.5 m • Cable length 5 m • Cable length 10 m	<b>3RK1902-4HB15-5AA0</b> <b>3RK1902-4HB50-5AA0</b> <b>3RK1902-4HC01-5AA0</b>
 3RK1902-4PB15-3AA0	<b>Control cable, assembled at both ends</b> Straight M12 plug, straight M12 socket, for screw fixing, 3-pole, 3 x 0.34 mm <sup>2</sup> , A-coded, black PUR sheath, max. 4 A • Cable length 1.5 m	<b>3RK1902-4PB15-3AA0</b>
 6ES7194-1KA01-0XA0	<b>M12 Y-shaped coupler plugs</b> For connection of two sensors to one M12 socket with Y assignment	<b>6ES7194-1KA01-0XA0</b>

## More information

**Industry Mall**

More information and technical specifications see Industry Mall under "Automation" ⇒ "Industrial Communication" ⇒ "IO-Link" ⇒ "Input Modules" ⇒ "IO-Link K20 Modules".

## IO-Link

### Contactors and contactor assemblies

#### SIRIUS 3RT20 contactors, 3-pole, 3 ... 18.5 kW

#### Overview

##### **Contactors with communication interface, sizes S00 and S0**

Contactor versions with communication interface are required to establish a connection to the control system via IO-Link or AS-Interface. The link is established by means of function modules mounted on the front of the contactor.

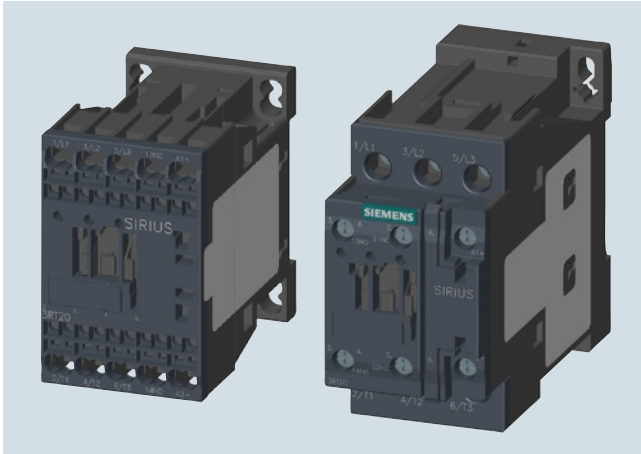

Contactor size S00 with communication interface and spring-type terminals and contactor size S0 with screw terminals

##### Standards

IEC 60947-1, EN 60947-1,  
IEC 60947-4-1, EN 60947-4-1,  
IEC 60947-5-1, EN 60947-5-1 (auxiliary switches)

The 3RT20 contactors for switching motors are climate-proof and are suitable and tested for use worldwide.

If the devices are used in ambient conditions which deviate from common industrial conditions (IEC 60721-3-3 "Stationary Use, Weather-Protected"), information must be obtained about possible restrictions with regard to the reliability and endurance of the device and possible protective measures. In this case contact our Technical Assistance.

3RT2 contactors are finger-safe according to EN 50274.

The contactors are suitable for screw fixing or for mounting onto TH 35 standard mounting rails according to IEC 60715.

##### Contact reliability

If voltages  $\leq 110$  V and currents  $\leq 100$  mA are to be switched, the auxiliary contacts of the 3RT2 contactor or 3RH21 contactor relay should be used as they guarantee a high level of contact reliability.

These auxiliary contacts are suitable for solid-state circuits with currents  $\geq 1$  mA at a voltage  $\geq 17$  V.

##### Connection methods

The 3RT2 contactors are available with screw terminals or spring-type terminals.

##### Short-circuit protection of the contactors

Short-circuit protection of the contactors without overload relay, see "Technical specifications" (see Note).

To assemble fuseless motor feeders you must select combinations of motor starter protector and contactor as explained in "3RA2 Load Feeders".

##### Motor protection

3RU21 thermal overload relays or 3RB30 solid-state overload relays can be fitted to the 3RT2 contactors for protection against overload. The overload relays must be ordered separately.

##### Ratings of three-phase motors

The quoted rating (in kW) refers to the output power on the motor shaft (according to the nameplate).

##### Control supply voltage

Contactors with communication interface are available with 24 V DC operation.

##### **Manuals and configurator**

For more information, see



- System manual "SIRIUS Innovations – System Overview", <http://support.automation.siemens.com/WW/view/en/60311318>
- Manual "SIRIUS Innovations – SIRIUS 3RT2 Contactors/ Contactor Assemblies", <http://support.automation.siemens.com/WW/view/en/60306557>

For online configurator see

[www.siemens.com/sirius/configurators](http://www.siemens.com/sirius/configurators).

## Selection and ordering data

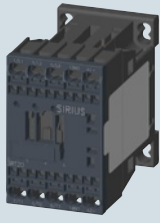
**DC operation · DC solenoid system**  
**Rated control supply voltage 24 V**

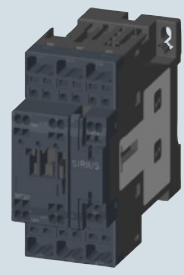
			
3RT201.-1BB4.-0CC0	3RT201.-2BB4.-0CC0	3RT202.-1BB40-0CC0	3RT202.-2BB40-0CC0
Rated data	Auxiliary contacts	Screw terminals	Spring-type terminals
AC-2 and AC-3, $T_U$ : Up to 60 ?	AC-1, $T_U$ : 40 ?		
Operational current $I_e$ up to 400 V	Rating of three-phase motors <sup>1)</sup> at 50 Hz and <b>400 V</b>	Operational current $I_e$ up to 690 V	Ident. No.      Version
A	kW	A	NO      NC
		Article No.	Article No.

For screw and snap-on mounting onto TH 35 standard mounting rail

Size S00

**Contactors with communication interface**

Terminal designations in accordance with DIN EN 50012 or DIN EN 50005

- With auxiliary contact 1 NO, Ident. No. **10**

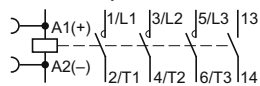

- With auxiliary contact 1 NC, Ident. No. **01**

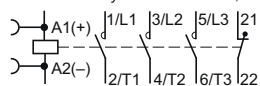

7	<b>3</b>	18	<b>10</b>	1	--	<b>3RT2015-1BB41-0CC0</b>	<b>3RT2015-2BB41-0CC0</b>
			<b>01</b>	--	1	<b>3RT2015-1BB42-0CC0</b>	<b>3RT2015-2BB42-0CC0</b>
9	<b>4</b>	22	<b>10</b>	1	--	<b>3RT2016-1BB41-0CC0</b>	<b>3RT2016-2BB41-0CC0</b>
			<b>01</b>	--	1	<b>3RT2016-1BB42-0CC0</b>	<b>3RT2016-2BB42-0CC0</b>
12	<b>5.5</b>	22	<b>10</b>	1	--	<b>3RT2017-1BB41-0CC0</b>	<b>3RT2017-2BB41-0CC0</b>
			<b>01</b>	--	1	<b>3RT2017-1BB42-0CC0</b>	<b>3RT2017-2BB42-0CC0</b>
16	<b>7.5</b>	22	<b>10</b>	1	--	<b>3RT2018-1BB41-0CC0</b>	<b>3RT2018-2BB41-0CC0</b>
			<b>01</b>	--	1	<b>3RT2018-1BB42-0CC0</b>	<b>3RT2018-2BB42-0CC0</b>

Size S0

**Contactors with communication interface**

Terminal designations according to EN 50012

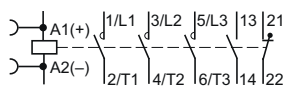

9	<b>4</b>	40	<b>11</b>	1	1	<b>3RT2023-1BB40-0CC0</b>	<b>3RT2023-2BB40-0CC0</b>
12	<b>5.5</b>	40	<b>11</b>	1	1	<b>3RT2024-1BB40-0CC0</b>	<b>3RT2024-2BB40-0CC0</b>
16	<b>7.5</b>	40	<b>11</b>	1	1	<b>3RT2025-1BB40-0CC0</b>	<b>3RT2025-2BB40-0CC0</b>
25	<b>11</b>	40	<b>11</b>	1	1	<b>3RT2026-1BB40-0CC0</b>	<b>3RT2026-2BB40-0CC0</b>
32	<b>15</b>	50	<b>11</b>	1	1	<b>3RT2027-1BB40-0CC0</b>	<b>3RT2027-2BB40-0CC0</b>
38	<b>18.5</b>	50	<b>11</b>	1	1	<b>3RT2028-1BB40-0CC0</b>	<b>3RT2028-2BB40-0CC0</b>

For online configurator see [www.siemens.com/sirius/configurators](http://www.siemens.com/sirius/configurators).

<sup>1)</sup> Guide value for 4-pole standard motors at 50 Hz 400 V AC.  
The actual starting and rated data of the motor to be switched must be considered when selecting the units.

## IO-Link

### Contactors and contactor assemblies

#### SIRIUS 3RA23 reversing contactor assemblies

##### Overview

The 3RA23 contactor assemblies for reversing can be ordered as follows:

- Complete, fully wired and tested, with mechanical and electrical interlock
- As individual parts for customer assembly.

The functions modules for establishing the connection to the control system must be separately ordered in both cases.

The auxiliary contacts integrated in the contactors (see page 5/19) can be freely assigned when function modules are used.

##### Selection and ordering data

###### Fully-wired and tested contactor assemblies

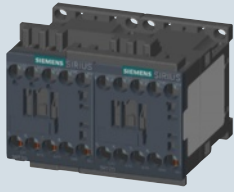
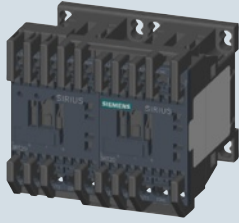
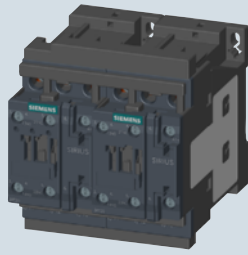
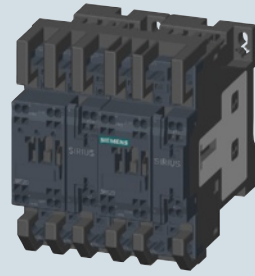
 3RA231.-8XE30-1BB4		 3RA231.-8XE30-2BB4		 3RA2324-8XE30-1BB4		 3RA2324-8XE30-2BB4	
Rated data AC-2 and AC-3				Screw terminals		Spring-type terminals	
Operational current $I_e$ up to	Ratings of three-phase motors <sup>1)</sup> at 50 Hz and						
400 V	230 V	400 V	500 V	690 V			
A	kW	kW	kW	kW	Article No.	Article No.	

##### DC operation 24 V

Size S00

###### With communication interface

7	2.2	3	3.5	4	3RA2315-8XE30-1BB4	3RA2315-8XE30-2BB4
9	3	4	4.5	5.5	3RA2316-8XE30-1BB4	3RA2316-8XE30-2BB4
12	3	5.5	5.5	5.5	3RA2317-8XE30-1BB4	3RA2317-8XE30-2BB4
16	4	7.5	7.5	7.5	3RA2318-8XE30-1BB4	3RA2318-8XE30-2BB4

Size S0

###### With communication interface

12	3	5.5	7.5	7.5	3RA2324-8XE30-1BB4	3RA2324-8XE30-2BB4
16	4	7.5	10	11	3RA2325-8XE30-1BB4	3RA2325-8XE30-2BB4
25	5.5	11	11	11	3RA2326-8XE30-1BB4	3RA2326-8XE30-2BB4
32	7.5	15	18.5	18.5	3RA2327-8XE30-1BB4	3RA2327-8XE30-2BB4
38	7.5	18.5	18.5	18.5	3RA2328-8XE30-1BB4	3RA2328-8XE30-2BB4

For online configurator see [www.siemens.com/sirius/configurators](http://www.siemens.com/sirius/configurators).

<sup>1)</sup> Guide value for 4-pole standard motors at 50 Hz 400 V AC.  
The actual starting and rated data of the motor to be switched must be considered when selecting the units.



**Selection and ordering data** (continued)**Components for customer assembly**

Assembly kits for all sizes are available for customer assembly of reversing contactor assemblies.

Contactors, overload relays and function modules for reversing starting must be ordered separately.

Selection of contactors for customer assembly

Rated data AC-2 and AC-3 for 50 Hz 400 V AC		Size	Article No.		
Rating kW	Operational current $I_e$ A		Contactor	Assembly kit	Complete assemblies
3	7	<b>S00</b>	3RT2015-.BB4.-0CC0	3RA2913-2AA.	<b>3RA2315-8XB30-.BB4</b>
4	9		3RT2016-.BB4.-0CC0		<b>3RA2316-8XB30-.BB4</b>
5.5	12		3RT2017-.BB4.-0CC0		<b>3RA2317-8XB30-.BB4</b>
7.5	16		3RT2018-.BB4.-0CC0		<b>3RA2318-8XB30-.BB4</b>
5.5	12	<b>S0</b>	3RT2024-.BB40-0CC0	3RA2923-2AA.	<b>3RA2324-8XB30-.BB4</b>
7.5	16		3RT2025-.BB40-0CC0		<b>3RA2325-8XB30-.BB4</b>
11	25		3RT2026-.BB40-0CC0		<b>3RA2326-8XB30-.BB4</b>
15	32		3RT2027-.BB40-0CC0		<b>3RA2327-8XB30-.BB4</b>
18.5	38		3RT2028-.BB40-0CC0		<b>3RA2328-8XB30-.BB4</b>

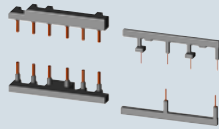
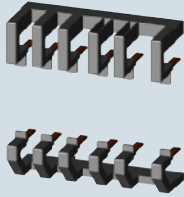
 3RA2923-2AA1			 3RA2923-2AA2		
Type			Article No.	Article No.	

**Assembly kits for making 3-pole contactor assemblies**

3RT201	<b>S00-S00</b>	The assembly kit contains: Mechanical interlock, 2 connecting clips for 2 contactors, wiring modules on the top and bottom • For main, auxiliary and control circuits	<b>3RA2913-2AA1</b>	<b>3RA2913-2AA2</b>
3RT202	<b>S0-S0</b>	The assembly kit contains: Mechanical interlock, 2 connecting clips for 2 contactors, wiring modules on the top and bottom • For main, auxiliary and control circuits • Only for main circuit <sup>1)</sup>	<b>3RA2923-2AA1</b>	<b>3RA2923-2AA2</b>

<sup>1)</sup> Version in size S0 with spring-type terminals:  
Only the wiring modules for the main circuit are included.  
No connectors are included for the auxiliary and control circuit.

## IO-Link

### Contactors and contactor assemblies

#### SIRIUS 3RA24 contactor assemblies for wye-delta starting

##### Overview

These 3RA24 contactor assemblies for wye-delta starting are designed for standard applications.

##### Note:

Contactor assemblies for wye-delta starting in special applications such as very heavy starting or wye-delta starting of special motors must be customized. Help with designing such special applications is available from Technical Assistance.

The 3RA24 contactor assemblies for wye-delta starting can be ordered as follows:

- Complete, fully wired and tested, with electrical and mechanical interlock
- As individual parts for customer assembly.

A dead interval of 50 ms on reversing is already integrated in the function module for wye-delta starting. The auxiliary contacts integrated in the contactors (see page 5/19) are unassigned.

##### Selection and ordering data

##### Fully-wired and tested contactor assemblies

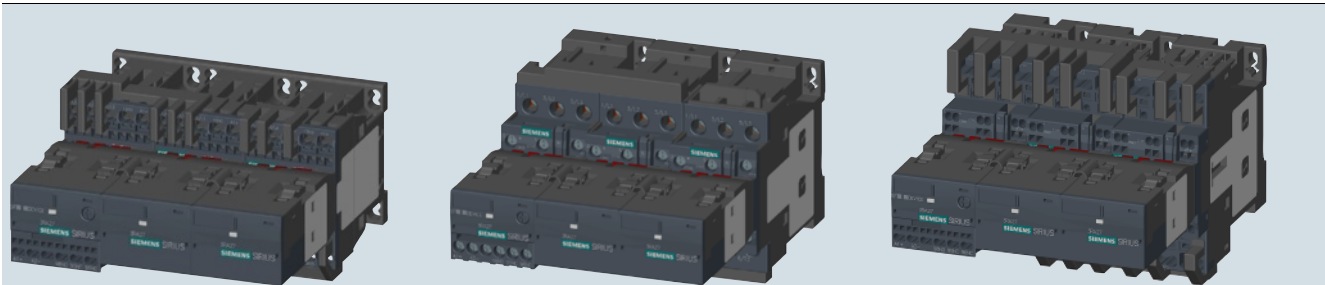

3RA241.-8XE31-2BB4

3RA242.-8XE32-1BB4

3RA242.-8XE32-2BB4

Rated data AC-3

Operational current  $I_e$  up toRatings of three-phase motors<sup>1)</sup> at 50 Hz and400 V      230 V      **400 V**      500 V      690 V

A              kW              kW              kW              kW              V

Rated control supply voltage  $U_s$ 

Screw terminals



Spring-type terminals



Article No.

Article No.

##### DC operation 24 V

##### Size S00

##### For IO-Link connection

12	3.3	<b>5.5</b>	7.2	9.2	24 DC
16	4.7	<b>7.5</b>	10.3	9.2	24 DC
25	5.5	<b>11</b>	11	11	24 DC

**3RA2415-8XE31-1BB4****3RA2415-8XE31-2BB4****3RA2416-8XE31-1BB4****3RA2416-8XE31-2BB4****3RA2417-8XE31-1BB4****3RA2417-8XE31-2BB4**

##### Size S0

##### For IO-Link connection

25	7.1	<b>11</b>	15.6	19	24 DC
32 / 40	11.4	<b>15 / 18.5</b>	19	19	24 DC
50	--	<b>22</b>	19	19	24 DC

**3RA2423-8XE32-1BB4****3RA2423-8XE32-2BB4****3RA2425-8XE32-1BB4****3RA2425-8XE32-2BB4****3RA2426-8XE32-1BB4****3RA2426-8XE32-2BB4**

For online configurator see [www.siemens.com/sirius/configurators](http://www.siemens.com/sirius/configurators).

<sup>1)</sup> Guide value for 4-pole standard motors at 50 Hz 400 V AC. The actual starting and rated data of the motor to be switched must be considered when selecting the units.

**Selection and ordering data** (continued)**Components for customer assembly**

Assembly kits with wiring modules and mechanical connectors are available for contactor assemblies for wye-delta starting. Contactors, overload relays, function modules for wye-delta starting, auxiliary switches for electrical interlock – if required also infeed terminals – must be ordered separately.

The wiring kits for sizes S00 and S0 contain the top and bottom main conducting path connections between the line and delta contactors (top) and between the delta and star contactors (bottom).

**Selection of contactors for customer assembly**

Rated data AC-3 at 50 Hz 400 V AC			Size	Article No.		Complete assemblies
Rating kW	Operational current $I_e$ A	Motor current A		Line/delta contactor	Star contactor	
5.5	12	9.5 ... 13.8	<b>S00-S00-S00</b>	3RT2015-.BB4.-0CC0	3RT2015-.BB4.-0CC0	<b>3RA2415-8XE31-.BB4</b>
7.5	16	12.1 ... 17		3RT2017-.BB4.-0CC0	3RT2015-.BB4.-0CC0	<b>3RA2416-8XE31-.BB4</b>
11	25	19 ... 25		3RT2018-.BB4.-0CC0	3RT2016-.BB4.-0CC0	<b>3RA2417-8XE31-.BB4</b>
11	25	19 ... 25	<b>S0-S0-S0</b>	3RT2024-.BB40-0CC0	3RT2024-.BB40-0CC0	<b>3RA2423-8XE32-.BB4</b>
15	32	24.1 ... 34		3RT2026-.BB40-0CC0	3RT2024-.BB40-0CC0	<b>3RA2425-8XE32-.BB4</b>
18.5	40	34.5 ... 40		3RT2026-.BB40-0CC0	3RT2024-.BB40-0CC0	<b>3RA2425-8XE32-.BB4</b>
22	50	31 ... 43		3RT2027-.BB40-0CC0	3RT2026-.BB40-0CC0	<b>3RA2426-8XE32-.BB4</b>

For contactors, see page 5/19.

For contactors	Size	Version	Article No.	Article No.
			<b>Screw terminals</b>	<b>Spring-type terminals</b>
Type				

**Assembly kits for making 3-pole contactor assemblies**

3RT201	<b>S00</b>	The assembly kit contains: Mechanical interlock, 4 connecting clips for 3 contactors; star jumper, wiring modules on the top and bottom • For main, auxiliary and control circuits	<b>3RA2913-2BB1</b>	<b>3RA2913-2BB2</b>
3RT202	<b>S0</b>	The assembly kit contains: Mechanical interlock, 4 connecting clips for 3 contactors, star jumper, wiring modules on the top and bottom <sup>1)</sup> • For main, auxiliary and control circuits • Only for main circuit <sup>2)</sup>	<b>3RA2923-2BB1</b> --	-- <b>3RA2923-2BB2</b>
	<b>S0</b>	The assembly kit contains: mechanical interlock; 2 connecting clips for 3 contactors, wiring modules on the top and bottom, 3-phase infeed terminals • For main, auxiliary and control circuits	<b>3RA2924-2BB1</b>	--

<sup>1)</sup> When using the function modules for wye-delta starting, the wiring modules included in the assembly kit for the auxiliary current are not required.

<sup>2)</sup> Version in size S0 with spring-type terminals:  
Only the wiring modules for the main circuit are included.  
No connectors are included for the auxiliary and control circuit.

## IO-Link

### Contactors and contactor assemblies

#### SIRIUS 3RA27 function module for IO-Link

##### Overview







The function modules for mounting onto contactors enable the configuration of starters and contactor assemblies for direct-on-line, reversing and wye-delta starting without any additional, complicated wiring of the individual components.

They include the key control functions required for the particular feeder, e.g. timing and interlocking, and can be connected to the control system via IO-Link.

##### Manuals

For more information see manual "SIRIUS Function Modules for IO-Link", <http://support.automation.siemens.com/WW/view/en/39319600>

##### Selection and ordering data

Version	Screw terminals	Spring-type terminals
Article No.	Article No.	Article No.
<b>Function modules for direct-on-line starting</b>		
 3RA2711-1AA0  3RA2711-2AA0 <b>IO-Link connection</b> Includes one module connector for assembling an IO-Link group	3RA2711-1AA0	3RA2711-2AA0
<b>Function modules for reversing starting <sup>1)</sup></b>		
 3RA2711-1BA0  3RA2711-2BA0 <b>IO-Link connection,</b> comprising one basic and one coupling module and an additional module connector for assembling an IO-Link group	3RA2711-1BA0	3RA2711-2BA0
<b>Function modules for wye-delta starting <sup>2)</sup></b>		
 3RA2711-1CA0  3RA2711-2CA0 <b>IO-Link connection,</b> comprising one basic module and two coupling modules, plus an additional module connector for assembling an IO-Link group	3RA2711-1CA0	3RA2711-2CA0





Suitable contactors or reversing contactor assemblies with communication interface are required (see pages 5/19 and 5/20).

##### Note:

When using the function modules, no other auxiliary switches are allowed to be connected to the basic units.

- <sup>1)</sup> For prewired contactor assemblies for reversing starting with communication interface, see page 5/20. When these contactor assemblies are used, the assembly kit for the wiring is already integrated.
- <sup>2)</sup> For complete contactor assemblies for wye-delta starting incl. function modules, see page 5/22.

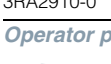
## Selection and ordering data (continued)

Version	Article No.	
<b>Accessories</b>		
 <p>3RA2711-0EE01</p>	<p><b>Module connector set</b>, comprising:</p> <ul style="list-style-type: none"> <li>• 2 module connectors, 14-pole, short</li> <li>• 2 interface covers</li> </ul>	3RA2711-0EE01
 <p>3RA2711-0EE02</p>	<p><b>Module connectors</b>, 14-pole, 8 cm</p> <p>For size jump S00-S0 + 1 space</p>	3RA2711-0EE02
 <p>3RA2711-0EE03</p>	<p><b>Module connectors</b>, 14-pole, 21 cm</p> <p>For various space combinations</p>	3RA2711-0EE03
 <p>3RA2711-0EE04</p>	<p><b>Module connectors</b>, 10-pole, 8 cm</p> <p>For separate auxiliary voltage infeed within an IO-Link group</p>	3RA2711-0EE04
 <p>3RA2910-0</p>	<p><b>Sealable covers</b></p> <p>for 3RA27, 3RA28, 3RA29</p>	3RA2910-0
<b>Operator panels<sup>1)</sup></b>		
 <p>3RA6935-0A</p>	<p><b>Operator panel (set)</b>, comprising:</p> <ul style="list-style-type: none"> <li>• 1 x operator panel</li> <li>• 1 x enabling module</li> <li>• 1 x interface cover</li> <li>• 1 x fixing terminal</li> </ul>	3RA6935-0A
	<p><b>Connection cable</b>, length 2 m, 10- to 14-pole</p> <p>For connecting the operator panel to the communication module</p>	3RA2711-0EE11
	Enabling modules (replacement)	3RA6936-0A
	Interface covers (replacement)	3RA6936-0B

<sup>1)</sup> Suitable only for communication through IO-Link.

## IO-Link

### SIRIUS 3RB24 solid-state overload relays for IO-Link

#### 3RB24 for IO-Link, up to 630 A for High-Feature applications

#### Overview

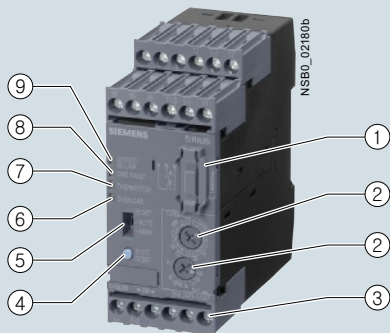

- ① Plug-in point for operator panel:  
enables connection of the 3RA6935-0A operator panel.
- ② Motor current and trip class setting:  
Setting the device to the motor current and to the required trip class dependent on the start-up conditions is easy with the two rotary switches.
- ③ Connecting terminals (removable terminal block):  
The generously sized terminals permit connection of two conductors with different cross-sections for the auxiliary, control and sensor circuits. Connection is possible with screw connection and alternatively with spring-type connection.
- ④ Test/RESET button:  
Enables testing of all important device components and functions, plus resetting of the device after a trip when manual RESET is selected.
- ⑤ Selector switch for manual/automatic RESET:  
With this switch you can choose between manual and automatic RESET.
- ⑥ Red LED "OVERLOAD":  
A continuous red light signals an active overload trip; a flickering led light signals an imminent trip (overload warning).
- ⑦ Red LED "THERMISTOR":  
A continuous red light signals an active thermistor trip.
- ⑧ Red LED "GND FAULT":  
A continuous red light signals an active ground-fault trip.
- ⑨ Green LED "DEVICE/IO-Link":  
A continuous green light signals that the device is working correctly, a green flickering light signals the communication through IO-Link.

#### SIRIUS 3RB24 evaluation module

The modular 3RB24 solid-state overload relay, which is powered via IO-Link (with monostable auxiliary contacts) up to 630 A (up to 820 A possible with a series transformer) have been designed for inverse-time delayed protection of loads with normal and heavy starting ("Function" see Manual "SIRIUS 3RB24 Solid-State Overload Relay for IO-Link", <http://support.automation.siemens.com/WW/view/en/46165627>) against excessive temperature rises due to overload, phase unbalance or phase failure. It comprises an evaluation unit, a current measuring module and a connecting cable.

The 3RB24 evaluation module also offers a motor starter function: The contactors, which are connected via the auxiliary contacts, can also be actuated for operation via IO-Link. In this way, direct, reversing and star-delta starters up to 630 A (or 830 A) can be connected to the controller wirelessly via the IO-Link controller.

An overload, phase unbalance or phase failure result in an increase of the motor current beyond the set rated motor current.

This current rise is detected by means of the current measuring module (see page 5/30) and electronically evaluated by the evaluation module which is connected to it. The evaluation electronics sends a signal to the auxiliary contacts. The auxiliary contacts then switch off the load by means of a contactor.

The break time depends on the ratio between the tripping current and current setting  $I_{\text{e}}$  and is stored in the form of a long-term stable tripping characteristic (see "Characteristic Curves" <http://support.automation.siemens.com/WW/view/en/20357046/134300>). The "tripped" status is signaled by means of a continuously illuminated red "OVERLOAD" LED and also reported as a group fault via IO-Link.

The LED indicates imminent tripping of the relay due to overload, phase unbalance or phase failure by flickering when the limit current has been violated. This warning can also be reported to the higher-level PLC via IO-Link at the 3RB24 overload relay.

In addition to the described inverse-time delayed protection of loads against excessive temperature rises, the 3RB24 solid-state overload relays also allow direct temperature monitoring of the motor windings (full motor protection) by connection with broken-wire interlock of a PTC sensor circuit. With this temperature-dependent protection, the loads can be protected against overheating caused indirectly by reduced coolant flow, for example, which cannot be detected by means of the current alone. In the event of overtemperature, the devices switch off the contactor, and thus the load, by means of the auxiliary contacts. The "tripped" status is signaled by means of a continuously illuminated "THERMISTOR" LED and also reported as a group fault via IO-Link.

To protect the loads against incomplete ground faults due to damage to the insulation, humidity, condensed water, etc., the 3RB24 solid-state overload relays offer the possibility of internal ground-fault detection (for details, see Manual "SIRIUS 3RB24 Solid-State Overload Relay for IO-Link", <http://support.automation.siemens.com/WW/view/en/46165627>, not possible in conjunction with contactor assemblies for wye-delta starting). In the event of a ground fault, the 3RB24 relays trip instantaneously.

The "tripped" status is signaled by means of a flashing red LED "Ground Fault" and reported at the 3RB24 overload relay as a group fault via IO-Link.

The reset after overload, phase unbalance, phase failure, thermistor or ground-fault tripping is performed manually by key on site, via IO-Link or by electrical remote RESET or automatically after the cooling time (motor model) or for thermistor protection after sufficient cooling. Power cuts in devices due to function monitors (broken wire or short-circuit on the thermistor) can only be reset on-site ("Function" see Manual "SIRIUS 3RB24 Solid-State Overload Relay for IO-Link", <http://support.automation.siemens.com/WW/view/en/46165627>).



**Overview** (continued)

In conjunction with a function expansion module, the motor current measured by the microprocessor can be output in the form of an analog signal DC 4 to 20 mA for operating rotary coil instruments or for feeding into analog inputs of programmable logic controllers.

The current values can be transmitted to the higher-level controller via IO-Link.

The 3RB24 solid-state overload relay for IO-Link is suitable for operation with frequency converters. Please follow the instructions in the manual "SIRIUS 3RB24 Solid-State Overload Relay for IO-Link", see <http://support.automation.siemens.com/WW/view/en/46165627>.

The devices are manufactured in accordance with environmental guidelines and contain environmentally friendly and reusable materials. They comply with all important worldwide standards and approvals.

**Type of protection "increased safety EEx e and explosion-proof enclosure EEx d" in accordance with ATEX Directive 94/9/EC**

The 3RB24 solid-state overload relay (monostable) are suitable for the overload protection of explosion-proof motors of types of protection EEx e and EEx d.

They comply with the requirements of IEC 60079-7 (Electrical devices for areas subject to explosion hazards - Increased safety "e" as well as for flameproof enclosure "d").

EC type test certificate for Group II, Category (2) G/D has been submitted. On request.

**Connection methods**

The evaluation modules of the 3RB24 solid-state overload relays for High-Feature applications are available with screw terminals (box terminals) or spring-type terminals at the auxiliary current end.

The 3RB29 current measuring modules are designed as straight-through modules. From size S6 upwards they are also available with an optional busbar connection.



Screw terminals



Spring-type terminals

The various terminals are indicated in the corresponding tables by the displayed symbols.

**Overload relays overview – matching contactors**

Overload relays	Current measuring module	Current range	Contactors (type, size, rating in kW)							
			3RT201.	3RT202.	3RT103.	3RT104.	3RT105.	3RT106.	3RT107.	3TF68/3TF69
Type	Type	A	S00	S0	S2	S3	S6	S10	S12	Size 14
			3/4/5.5/7.5	5.5/7.5/11	15/18.5/22	30/37/45	55/75/90	110/132/160	200/250	375/450

**SIRIUS 3RB24 solid-state overload relays<sup>1)</sup>**

3RB24

3RB2483 +	3RB2906	3RB2906	3RB2956	3RB2966	3RB2906 + 3UF18	3RT201.	3RT202.	3RT103.	3RT104.	3RT105.	3RT106.	3RT107.	3TF68/3TF69
	0.3 ... 25	10 ... 100	20 ... 200	63 ... 630	630 ... 820	✓	✓	--	--	--	--	--	--
	✓	✓	--	✓	--	✓	✓	✓	✓	✓	✓	✓	✓
	--	✓	✓	--	--	--	--	--	--	--	✓	✓	✓
	--	--	--	--	--	--	--	--	--	--	--	--	✓

✓ Can be used

-- Cannot be used

<sup>1)</sup> "Technical specifications" for the use of overload relays with trip class ≥ CLASS 20 can be found in "Short-circuit protection with fuses for motor feeders", see Configuration Manuals

- "SIRIUS Configuration – Selection Data for Fuseless Load Feeders", <http://support.automation.siemens.com/WW/view/en/40625241>

- "Configuring SIRIUS Innovations – Selection data for Fuseless and Fused Load Feeders", <http://support.automation.siemens.com/WW/view/en/39714188>.

**Benefits**

The key features and benefits of the 3RB24 solid-state overload relays for IO-Link are listed in the overview table (see Catalog IC 10, Chapter 7 "Protection Equipment" → "Overload Relays" → "General Data").

**IO-Link****SIRIUS 3RB24 solid-state overload relays for IO-Link****3RB24 for IO-Link, up to 630 A for High-Feature applications****Application****Industries**

The 3RB24 solid-state overload relays are suitable for customers from all industries who want to guarantee optimum inverse-time delayed and temperature-dependent protection of their electrical loads (e.g. motors) under normal and heavy starting conditions (CLASS 5 to 30), minimize project completion times, inventories and energy consumption, and optimize plant availability and maintenance management.

**Application area**

The 3RB24 solid-state overload relays have been designed for the protection of three-phase asynchronous and single-phase AC motors.

In addition to protection function, these devices can be used together with contactors as direct or reversing starters (star-delta (wye-delta) start also possible), which are controlled via IO-Link. This makes it possible to directly control drives via IO-Link from a higher-level controller or on site via the optional hand-held device lamps and also, for example, to return current values directly via IO-Link.

If single-phase AC motors are to be protected by the 3RB24 solid-state overload relays, the main current paths of the current measuring modules must be series-connected ("Circuit Diagrams" see Manual "SIRIUS 3RB24 Solid-State Overload Relay for IO-Link", <http://support.automation.siemens.com/WW/view/en/46165627>).

**Ambient conditions**

The devices are insensitive to external influences such as shocks, corrosive ambient conditions, ageing and temperature fluctuations.

For the temperature range from  $-25\text{ °C}$  to  $+60\text{ °C}$ , the 3RB24 solid-state overload relays compensate the temperature in accordance with IEC 60947-4-1.

Configuration notes for use of the devices below  $-25\text{ °C}$  or above  $+60\text{ °C}$  on request.

## Selection and ordering data

**3RB24 solid-state overload relays (evaluation modules) for full motor protection, stand-alone installation, CLASS 5, 10, 20 and 30, adjustable**

Type	3RB2483-4A.1
<b>Features and technical specifications</b>	
Overload protection, phase failure protection and unbalance protection	✓
Supplied from an external voltage	✓ 24 V DC through IO-Link
Direct-on-line or reversing starters (wye-delta starting also possible) controllable through IO-Link	✓
Auxiliary contacts	✓ 1 CO and 1 NO in series
Manual and automatic RESET	✓
Remote-RESET	✓ (electrically or via IO-Link)
Four LEDs for operating and status displays	✓
TEST function and self-monitoring	✓
Internal ground-fault detection	✓
Screw or spring-type terminals for auxiliary, control and sensor circuits	✓
Input for PTC sensor circuit	✓
Analog output	✓
<b>IO-Link-specific functions</b>	
• Connection of direct-on-line, reversing and star-delta starters to the controller via IO-Link	✓
• On-site controlling of the starter using the hand-held device	✓
• Accessing process data (e.g. current values in all three phases) via IO-Link	✓
• Accessing parameterization and diagnostics data (e.g. tripped signals) via IO-Link	✓

✓ Available

PU (UNIT, SET, M) = 1  
PS\* = 1 unit  
PG = 41G

Size	Version	Image	Terminal Type	Article No.
contactor			Screw terminals	3RB2483-4AA1
			Spring-type terminals	3RB2483-4AC1

**Evaluation modules**

S00 ... S12 Monostable

3RB2483-4AA1

3RB2483-4AC1

**Notes:**

Overview of overload relays – matching contactors see page 5/27.

Analog input modules, e.g. SM 331, must be configured for 4-wire measuring transducers. The analog input module may not supply current to the analog output of the 3RB24 relay.

For current measuring modules and related connecting cables see next page, "Accessories" see pages 5/31 and 5/32.

## IO-Link

### SIRIUS 3RB24 solid-state overload relays for IO-Link

#### Current measuring modules





##### Overview

The current measuring modules are designed as system components for connecting to 3RB24 evaluation units. Using these evaluation units the motor current is measured and the measured value sent to the evaluation unit for evaluation.

The current measuring modules in sizes S00 to S3 up to 55 mm wide are equipped with straight-through transformers and can be snap-fitted under the evaluation units. The larger evaluation units are installed directly on the contactor or as stand-alone units.

##### Selection and ordering data

###### Current measuring modules for mounting onto contactor<sup>1)</sup> and stand-alone installation<sup>1) 2)</sup> (essential accessories)

	Size contactor <sup>3)</sup>	Rating for three-phase motor, rated value <sup>4)</sup>	Current setting value of the inverse-time delayed overload release	Short-circuit protection with fuse, type of coordination "2", operational class gG <sup>5)</sup>	For overload relays	Article No.
		kW	A			
<b>Sizes S00/S0<sup>2) 6)</sup></b>						
	S00/S0	0,09 ... 1,1	0,3 ... 3	20	3RB24	<b>3RB2906-2BG1</b> <b>3RB2906-2DG1</b>
		1,1 ... 11	2,4 ... 25	63		
<b>Sizes S2/S3<sup>2) 6)</sup></b>						
	S2/S3	5,5 ... 45	10 ... 100	315	3RB24	<b>3RB2906-2JG1</b>
<b>Size S6<sup>1) 6)</sup></b>						
	S6 with busbar connection	11 ... 90	20 ... 200	315	3RB24	<b>3RB2956-2TH2</b>
	For mounting onto S6 contactors with box terminals	11 ... 90	20 ... 200	315	3RB24	<b>3RB2956-2TG2</b>
<b>Sizes S10/S12<sup>1)</sup></b>						
	S10/S12 and size 14 (3TF68/ 3TF69)	37 ... 450	63 ... 630	800	3RB24	<b>3RB2966-2WH2</b>

##### Note:

The connecting cable between the current measuring module and the evaluation module is not included in the scope of supply; please order separately.

1) The current measuring modules with an Article No. ending with "2" are designed for mounting onto contactor and stand-alone installation. For 3TF68/3TF69 contactors, direct mounting is not possible.

2) The current measuring modules with an Article No. ending with "1" are designed for stand-alone installation.

3) Observe maximum rated operational current of the devices.

4) Guide value for 4-pole standard motors at 50 Hz 400 V AC. The actual starting and rated data of the motor to be protected must be considered when selecting the units.

5) Maximum protection by fuse only for overload relay, type of coordination "2". For fuse values in connection with contactors see Configuration Manuals  
- "Configuring SIRIUS Innovations – Selection Data for Fuseless and Fused Load Feeders", <http://support.automation.siemens.com/WW/view/en/39714188>  
- "SIRIUS Configuration – Selection Data for Fuseless Load Feeders", <http://support.automation.siemens.com/WW/view/en/40625241>.

6) The modules with an Article No. with "G" in penultimate position are equipped with a straight-through transformer.

##### Accessories

	Size contactor	Version	For overload relays	Article No.
<b>Connecting cables (necessary accessories)</b>				
	S00 ... S3	For connection between evaluation module and current measuring module • Length 0.1 m (only for mounting of the evaluation module directly onto the current measuring module)	3RB24, 3RB29	<b>3RB2987-2B</b>
	S00 ... S12	• Length 0.5 m	3RB24, 3RB29	<b>3RB2987-2D</b>

Additional general accessories see page 5/32.

## Overview

### Overload relays for High-Feature applications

The following optional accessories are available for the 3RB24 solid-state overload relays:

- Operator panel for the 3RB24 evaluation modules
- Manual for the 3RB24 evaluation modules
- Sealable covers for the 3RB24 evaluation modules
- Terminal covers for the 3RB29 current measuring modules size S6 and S10/S12
- Box terminal blocks for the 3RB29 current measuring modules size S6 and S10/S12
- Push-in lugs for screw fixing for 3RB24 evaluation modules and 3RB2906 current measuring modules

## Selection and ordering data

### Accessories for 3RB24 overload relays

Version	For overload relays	Article No.
<b>Operator panels for evaluation modules</b>		
 3RA6935-0A <b>Operator panels (set)</b> One set comprises: • 1 x operator panel • 1 x 3RA6936-0A enabling module • 1 x 3RA6936-0B interface cover • 1 x fixing terminal <b>Note:</b> The connecting cable between the evaluation module and the operator panel is not included in the scope of supply; please order separately.	3RB24	<b>3RA6935-0A</b>
<b>Connecting cable</b> Length 2.5 m (round), for connecting the evaluation module to the operator panel	3RB24	<b>3UF7933-0BA00-0</b>
<b>Enabling modules (replacement)</b>	3RB24	<b>3RA6936-0A</b>
<b>Interface covers</b>	3RB24	<b>3RA6936-0B</b>

### Manuals



Manual  
"Solid-State Overload Relay  
for IO-Link"

#### Manual "Solid-State Overload Relay for IO-Link"

The manual can be downloaded free of charge in PDF format from the Internet, see <http://support.automation.siemens.com/WW/view/en/46165627>.

Additional general accessories see next page.

**IO-Link**

## SIRIUS 3RB24 solid-state overload relays for IO-Link

## Accessories

**Selection and ordering data** (continued)**General accessories**

Version	Size	For overload relays	Article No.
<b>Sealable covers for evaluation modules</b>			
 For covering the setting knobs	--	3RB24	<b>3RB2984-2</b>
3RB2984-2			



**Terminal covers for current measuring modules**

Version	Size	For overload relays	Article No.
<b>Covers for cable lugs and busbar connections</b>			
• Length 100 mm	S6	3RB2956	<b>3RT1956-4EA1</b>
• Length 120 mm	S10/S12	3RB2966	<b>3RT1966-4EA1</b>
<b>Covers for box terminals</b>			
• Length 25 mm	S6	3RB2956	<b>3RT1956-4EA2</b>
• Length 30 mm	S10/S12	3RB2966	<b>3RT1966-4EA2</b>
<b>Covers for screw terminals</b>			
between contactor and overload relay, without box terminals (1 unit required per combination)	S6	3RB2956	<b>3RT1956-4EA3</b>
	S10/S12	3RB2966	<b>3RT1966-4EA3</b>
3RT1956-4EA2			

**Box terminal blocks for current measuring modules**

Version	Size	For overload relays	Article No.
For round and ribbon cables			
• Up to 70 mm <sup>2</sup>	S6 <sup>1)</sup>	3RB2956	<b>3RT1955-4G</b>
• Up to 120 mm <sup>2</sup>	S6	3RB2956	<b>3RT1956-4G</b>
• Up to 240 mm <sup>2</sup>	S10/S12	3RB2966	<b>3RT1966-4G</b>
For technical specifications for conductor cross-sections see Reference Manual "Protection Equipment – 3RU1, 3RB2 Overload Relays", <a href="http://support.automation.siemens.com/WWW/view/en/35681297">http://support.automation.siemens.com/WWW/view/en/35681297</a> .			
3RT195-4G			

**Push-in lugs for evaluation modules and current measuring modules**

Version	Size	For overload relays	Article No.
 For screw fixing the evaluation modules	--	3RB24	<b>3RP1903</b>
3RP1903			
 For screw fixing the current measuring modules (2 units per module)	S00 ... S3	3RB2906	<b>3RB1900-0B</b>
3RB1900-0B			

<sup>1)</sup> In the scope of supply for 3RT1054-1 contactors (55 kW).

Version	Size	Color	For overload relays	Spring-type terminals Article No.
<b>Tools for opening spring-type terminals</b>				
 <b>Screwdrivers</b> For all SIRIUS devices with spring-type terminals	Length approx. 200 mm, 3.0 mm x 0.5 mm	Titanium gray/black, partially insulated	Main and auxiliary circuit connection: 3RB24	<b>3RA2908-1A</b>
3RA2908-1A				

**Blank labels**

Version	Size	Color	For overload relays	Article No.
 <b>Unit labeling plates<sup>1)</sup></b> for SIRIUS devices	20 mm x 7 mm	Pastel turquoise	3RB24	<b>3RT1900-1SB20</b>
	20 mm x 7 mm	Titanium gray	3RB24	<b>3RT2900-1SB20</b>
3RT1900-1SB20				
3RT2900-1SB20				

<sup>1)</sup> PC labeling system for individual inscription of unit labeling plates available from: murrplastik Systemtechnik GmbH (see Catalog IC 10, Chapter 16, "Appendix" ⇒ "External Partners").



## Overview

### Communications integration using IO-Link

The 3RA64/65 compact starters comply with IO-Link specification V1.0. Up to 4 compact starters in IO-Link version (reversing and direct-on-line starters) can be connected together and easily linked to the IO-Link master through a standardized IO-Link connection. The 4SI SIRIUS electronic module can be used, for example, as an IO-Link master for the connection to the SIMATIC ET 200S distributed I/O system.

The IO-Link connection enables a high density of information in the local range.

The diagnostics data of the process collected by the 3RA6 compact starter, e.g. short circuit, end of service life, limit position etc., are not only indicated on the compact starter itself but also transmitted to the higher-level control system through IO-Link.







Thanks to the optionally available operator panel, which can be installed in the control cabinet door, it is easy to control the 3RA6 compact starter with IO-Link from the control cabinet door.

### Note

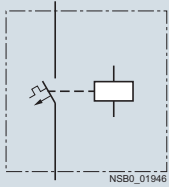
For general data about 3RA6 compact starters, see Chapter 4 "AS-Interface" ⇒ "3RA6 Compact Starters" ⇒ "General Data"

## Selection and ordering data

### 3RA64 direct-on-line starters

		<b>Direct-on-line start</b> 		<b>Rated control supply voltage 24 V DC</b> Width 45 mm Rated short-circuit current $I_{CS} = 53 \text{ kA}$ at 400 V A set of 3A6940-0A adapters is required for screw fixing.	
3RA64 with 3RA6911-1A auxiliary switch block				<b>Screw terminals</b> 	<b>Spring-type terminals</b> 
Standard three-phase motor 4-pole at 400 V AC <sup>1)</sup> Standard output $P$	Setting range for solid-state overload release	Instantaneous overcurrent release			
					
kW	A	A	<b>Article No.</b>	<b>Article No.</b>	

**For standard mounting rail or screw fixing, including 1 pair of main circuit terminals and 1 pair of control circuit terminals**





0.09	0.1 ... 0.4	56	<b>3RA6400-1AB42</b>	<b>3RA6400-2AB42</b>
0.37	0.32 ... 1.25	56	<b>3RA6400-1BB42</b>	<b>3RA6400-2BB42</b>
1.5	1 ... 4	56	<b>3RA6400-1CB42</b>	<b>3RA6400-2CB42</b>
5.5	3 ... 12	168	<b>3RA6400-1DB42</b>	<b>3RA6400-2DB42</b>
15	8 ... 32	448	<b>3RA6400-1EB42</b>	<b>3RA6400-2EB42</b>

**For use in the infeed system for 3RA6, without main circuit terminals with 1 pair of control circuit terminals**

0.09	0.1 ... 0.4	56	<b>3RA6400-1AB43</b>	<b>3RA6400-2AB43</b>
0.37	0.32 ... 1.25	56	<b>3RA6400-1BB43</b>	<b>3RA6400-2BB43</b>
1.5	1 ... 4	56	<b>3RA6400-1CB43</b>	<b>3RA6400-2CB43</b>
5.5	3 ... 12	168	<b>3RA6400-1DB43</b>	<b>3RA6400-2DB43</b>
15	8 ... 32	448	<b>3RA6400-1EB43</b>	<b>3RA6400-2EB43</b>

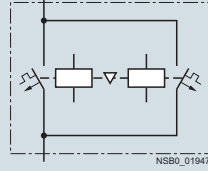
<sup>1)</sup> The actual starting and rated data of the motor to be protected must be considered when selecting the units.

**IO-Link****SIRIUS 3RA6 compact starters****SIRIUS 3RA64, 3RA65 compact starters for IO-Link****Selection and ordering data** (continued)**3RA65 reversing starters**

 <p>3RA65 with 3RA6911-1A auxiliary switch blocks</p>		<p><b>Reversing duty</b></p>  <p>NSB0_01947</p>		<p><b>Rated control supply voltage 24 V DC</b></p> <p>Width 90 mm</p> <p>Rated short-circuit current <math>I_{CS} = 53 \text{ kA}</math> at 400 V</p> <p>Two sets of 3RA6940-0A adapters are required for screw fixing.</p>	
Standard three-phase motor 4-pole at 400 V AC <sup>1)</sup>	Setting range for solid-state overload release	Instantaneous overcurrent release	<b>Screw terminals</b>	<b>Spring-type terminals</b>	
Standard output $P$					
kW	A	A	<b>Article No.</b>	<b>Article No.</b>	

*For standard mounting rail or screw fixing, including 1 pair of main circuit terminals and 1 pair of control circuit terminals*

0.09	0.1 ... 0.4	56	<b>3RA6500-1AB42</b>	<b>3RA6500-2AB42</b>
0.37	0.32 ... 1.25	56	<b>3RA6500-1BB42</b>	<b>3RA6500-2BB42</b>
1.5	1 ... 4	56	<b>3RA6500-1CB42</b>	<b>3RA6500-2CB42</b>
5.5	3 ... 12	168	<b>3RA6500-1DB42</b>	<b>3RA6500-2DB42</b>
15	8 ... 32	448	<b>3RA6500-1EB42</b>	<b>3RA6500-2EB42</b>

*For use in the infeed system for 3RA6, without main circuit terminals with 1 pair of control circuit terminals*

0.09	0.1 ... 0.4	56	<b>3RA6500-1AB43</b>	<b>3RA6500-2AB43</b>
0.37	0.32 ... 1.25	56	<b>3RA6500-1BB43</b>	<b>3RA6500-2BB43</b>
1.5	1 ... 4	56	<b>3RA6500-1CB43</b>	<b>3RA6500-2CB43</b>
5.5	3 ... 12	168	<b>3RA6500-1DB43</b>	<b>3RA6500-2DB43</b>
15	8 ... 32	448	<b>3RA6500-1EB43</b>	<b>3RA6500-2EB43</b>

<sup>1)</sup> The actual starting and rated data of the motor to be protected must be considered when selecting the units.

#### Overview

##### Accessories for SIRIUS 3RA6 compact starters in IO-Link version



The following accessories are available specially for the 3RA64, 3RA65 compact starters:

- The 4SI SIRIUS electronic module as IO-Link master allows for the simple and economical connection of SIRIUS controls with IO-Link (e.g. up to four groups of 4 compact starters) to the multifunctional SIMATIC ET 200S distributed I/O system.
- Additional connection cables for side-by-side mounting of up to 4 compact starters
- Operator panel for on-site control and diagnostics of up to 4 compact starters coupled to each other

##### Note

Accessories for all 3RA6 SIRIUS compact starters, see Chapter 4 "AS-Interface" ⇒ "3RA6 Compact Starters" ⇒ "Accessories"

#### Selection and ordering data

Version	Article No.
<i>Accessories especially for 3RA64, 3RA65 compact starters for IO-Link</i>	
 <p>3RA6931-0A</p> <p><b>Additional connection cables (flat) for side-by-side mounting of up to 4 compact starters</b></p> <ul style="list-style-type: none"> <li>• 10-pole           <ul style="list-style-type: none"> <li>- 8 mm<sup>1)</sup></li> <li>- 200 mm<sup>1)</sup></li> </ul> </li> <li>• 14-pole           <ul style="list-style-type: none"> <li>- 8 mm<sup>2)</sup></li> <li>- 200 mm</li> </ul> </li> </ul>	<p><b>3RA6932-0A</b></p> <p><b>3RA6933-0B</b></p> <p><b>3RA6931-0A</b></p> <p><b>3RA6933-0C</b></p>
 <p>3RA6935-0A</p> <p><b>Operator panel</b> (incl. enabling module, blanking cover and mounting bracket)</p>	<p><b>3RA6935-0A</b></p>
<b>Enabling module</b>	<b>3RA6936-0A</b>
<b>Blanking cover</b>	<b>3RA6936-0B</b>
<b>Connection cable (round) for connecting the operator panel</b> 10-pole, 2 000 mm	<b>3RA6933-0A</b>

<sup>1)</sup> 10-pole connection cables are required for EMERGENCY-STOP group concepts.

<sup>2)</sup> Is included in the scope of supply of the SIRIUS 3RA6 compact starter in IO-Link version.

## IO-Link

### SIRIUS 3RR24 monitoring relays for mounting onto 3RT2 contactors for IO-Link

#### General data

#### Overview

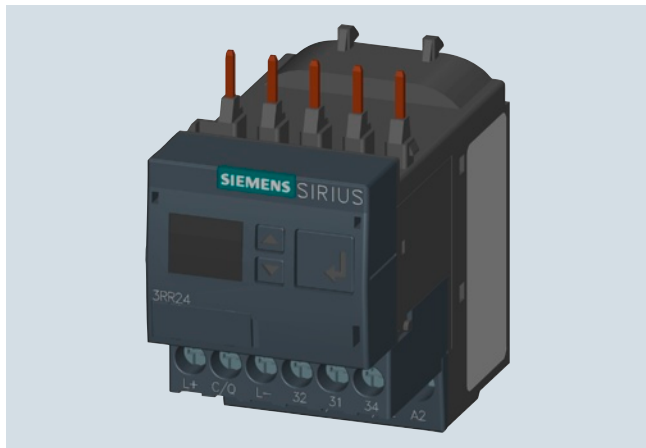

Features	3RR24	Benefits
<b>General data</b>		
<b>Sizes</b> Dimensions in mm (W x H x D) <ul style="list-style-type: none"> <li>• Screw terminals</li> <li>• Spring-type terminals</li> </ul>	 S00, S0 S00: 45 x 79 x 80, S0: 45 x 87 x 91 S00: 45 x 90 x 80, S0: 45 x 109 x 92	<ul style="list-style-type: none"> <li>• Are coordinated with the dimensions, connections and technical characteristics of the other devices in the SIRIUS modular system (contactors, soft starters, etc.)</li> <li>• Permit the mounting of slim and compact load feeders in widths of 45 mm (S00 and S0)</li> <li>• Simplify configuration</li> </ul>
<b>Current range</b>	S00: 1.6 ... 16 A S0: 4 ... 40 A	<ul style="list-style-type: none"> <li>• Is adapted to the other devices in the SIRIUS modular system</li> <li>• Just a single version per size with a wide setting range enables easy configuration</li> </ul>
<b>Permissible ambient temperature</b> During operation	-25 ... +60 °C	<ul style="list-style-type: none"> <li>• Suitable for applications in the control cabinet, worldwide</li> </ul>
<b>Monitoring functions</b>		
<b>Current overshoot</b>	✓ (Three-phase)	<ul style="list-style-type: none"> <li>• Provides optimum inverse-time delayed protection of loads against excessive temperature rises due to overload</li> <li>• Enables detection of filter blockages or pumping against closed gate valves</li> <li>• Enables drawing conclusions about wear, poor lubrication or other maintenance-relevant phenomena</li> </ul>
<b>Current undershoot</b>	✓ (Three-phase)	<ul style="list-style-type: none"> <li>• Enables detection of overload due to a slipping or torn belt</li> <li>• Guarantees protection of pumps against dry running</li> <li>• Facilitates monitoring of the functions of resistive loads such as heaters</li> <li>• Permits energy savings through monitoring of no-load operation</li> </ul>
<b>Apparent current monitoring</b>	✓ (selectable)	<ul style="list-style-type: none"> <li>• Precision current monitoring especially in a motor's rated and upper torque range</li> </ul>
<b>Active current monitoring</b>	✓ (selectable)	<ul style="list-style-type: none"> <li>• Optimum current monitoring over a motor's entire torque range through the patented combination of power factor and apparent current monitoring</li> </ul>
<b>Range monitoring</b>	✓ (Three-phase)	<ul style="list-style-type: none"> <li>• Simultaneous monitoring of current overshoot and undershoot with a single device</li> </ul>
<b>Phase failure, open circuit</b>	✓ (Three-phase)	<ul style="list-style-type: none"> <li>• Minimizes heating of three-phase motors during phase failure through immediate disconnection</li> <li>• Prevents operation of hoisting equipment with reduced load carrying capacity</li> </ul>
<b>Phase sequence monitoring</b>	✓ (selectable)	<ul style="list-style-type: none"> <li>• Prevents starting of motors, pumps or compressors in the wrong direction of rotation</li> </ul>
<b>Internal ground-fault detection (residual current monitoring)</b>	✓ (selectable)	<ul style="list-style-type: none"> <li>• Provides optimum protection of loads against high-resistance short circuits or ground faults due to moisture, condensed water, damage to the insulation material, etc.</li> <li>• Eliminates the need for additional special equipment</li> <li>• Saves space in the control cabinet</li> <li>• Reduces wiring overhead and costs</li> </ul>
<b>Blocking current monitoring</b>	✓ (selectable)	<ul style="list-style-type: none"> <li>• Minimizes heating of three-phase motors when blocked during operation through immediate disconnection</li> <li>• Minimizes mechanical loading of the system by acting as an electronic shear pin</li> </ul>
<b>Operating hours counter</b>	✓	<ul style="list-style-type: none"> <li>• Gives the time during which there was a measurable current in at least 2 current paths</li> <li>• As an indicator for upcoming maintenance or replacement of machine and system components</li> </ul>
<b>Operating cycles counter</b>	✓	<ul style="list-style-type: none"> <li>• Is incremented by one each time a breaking operation is detected, in other words a transition from three-phase current flow to no measurable current flow</li> <li>• As an indicator for upcoming maintenance or replacement of contact blocks</li> </ul>

✓ Available

## Overview (continued)

Features	3RR24	Benefits
<b>Features</b>		
<b>RESET function</b>	✓	<ul style="list-style-type: none"> <li>Allows manual or automatic resetting of the relay</li> <li>Resetting directly on the device, by switching the control supply voltage off and on or via IO-Link (remote RESET)</li> </ul>
<b>ON-delay time</b>	0 ... 999.9 s	<ul style="list-style-type: none"> <li>Enables motor starting without evaluation of the starting current</li> <li>Can be used for monitoring motors with lengthy start-up</li> </ul>
<b>Tripping delay time</b>	0 ... 999.9 s	<ul style="list-style-type: none"> <li>Permits brief threshold value violations during operation</li> <li>Prevents frequent warnings and disconnections with currents near the threshold values</li> </ul>
<b>Operating and indicating elements</b>	Displays and buttons	<ul style="list-style-type: none"> <li>For setting the threshold values and delay times</li> <li>For selectable functions</li> <li>For quick and selective diagnostics</li> <li>Displays for permanent display of measured values</li> </ul>
<b>Integrated contacts</b>	1 CO contact, 1 semiconductor output (in SIO mode)	<ul style="list-style-type: none"> <li>Enable disconnection of the system or process when there is an irregularity</li> <li>Can be used to output signals</li> </ul>
<b>Design of load feeders</b>		
<b>Short-circuit strength up to 100 kA at 690 V</b> (in conjunction with the corresponding fuses or the corresponding motor starter protector)	✓	<ul style="list-style-type: none"> <li>Provides optimum protection of the loads and operating personnel in the event of short circuits due to insulation faults or faulty switching operations</li> </ul>
<b>Electrical and mechanical matching to 3RT2 contactors</b>	✓	<ul style="list-style-type: none"> <li>Simplifies configuration</li> <li>Reduces wiring outlay and costs</li> <li>Enables stand-alone installation as well as space-saving direct mounting</li> </ul>
<b>Spring-type terminals for main circuit and auxiliary circuits</b>	✓ (optional)	<ul style="list-style-type: none"> <li>Enables fast connections</li> <li>Permits vibration-resistant connections</li> <li>Enables maintenance-free connections</li> </ul>
<b>Other features</b>		
<b>Suitable for single- and three-phase loads</b>	✓	<ul style="list-style-type: none"> <li>Enables the monitoring of single-phase systems through parallel infeed at the contactor or looping the current through the three phase connections</li> </ul>
<b>Wide setting ranges</b>	✓	<ul style="list-style-type: none"> <li>Reduce the number of variants</li> <li>Minimize the configuration outlay and costs</li> <li>Minimize storage overheads, storage costs, tied-up capital</li> </ul>
<b>Power supply</b>	24 V DC	<ul style="list-style-type: none"> <li>Direct via IO-Link master or via an external auxiliary voltage independent of the IO-Link</li> <li>Minimizes the configuring overhead and costs</li> </ul>

✓ Available

## IO-Link

SIRIUS 3RR24 monitoring relays for mounting onto 3RT2 contactors for IO-Link

### General data

#### Overview (continued)

##### Possible combinations of 3RR24 monitoring relays with 3RT2 contactors for IO-Link

Monitoring relays	Current range	Contactors (type, size, rating)	
		3RT201	3RT202
Type	A	S00 3/4/5.5/7.5 kW	S0 5.5/7.5/11/15/18.5 kW
3RR2441	1.6 ... 16	✓	With stand-alone installation support
3RR2442	4 ... 40	With stand-alone installation support	✓

✓ Available

#### Notes:

Devices required for the communication via IO-Link:

- Any controller that supports the IO-Link (e.g. ET 200S with CPU or S7-1200), see Catalog ST 70 "Products for Totally Integrated Automation"
- IO-Link master (e.g. 4SI or 4SI IO-Link electronic module for SIMATIC ET200S or SM 1278 for S7-1200) see Catalog ST 70 "Products for Totally Integrated Automation"

Each monitoring relay requires an IO-Link channel.

#### Connection methods

Selection tables for the 3RR24 monitoring relays can be found on the following pages.



Screw terminals



Spring-type terminals

5

#### More information

Configuration Manual "Configuring SIRIUS Innovations – Selection Data for Fuseless and Fused Load Feeders" see <http://support.automation.siemens.com/WW/view/en/39714188>.

System Manual "Industrial Controls – SIRIUS Innovations" see <http://support.automation.siemens.com/WW/view/en/60311318>.

Manual "3UG48/3RR24 Monitoring Relays for IO-Link" see <http://support.automation.siemens.com/WW/view/en/54375430>.

#### Notes on safety:

System networking requires suitable protective measures (including network segmentation for IT security) in order to ensure safe plant operation, see [www.siemens.com/industrialsecurity](http://www.siemens.com/industrialsecurity).

More information about the subject of Industrial Security see [www.siemens.com/industrialsecurity](http://www.siemens.com/industrialsecurity).

## Overview

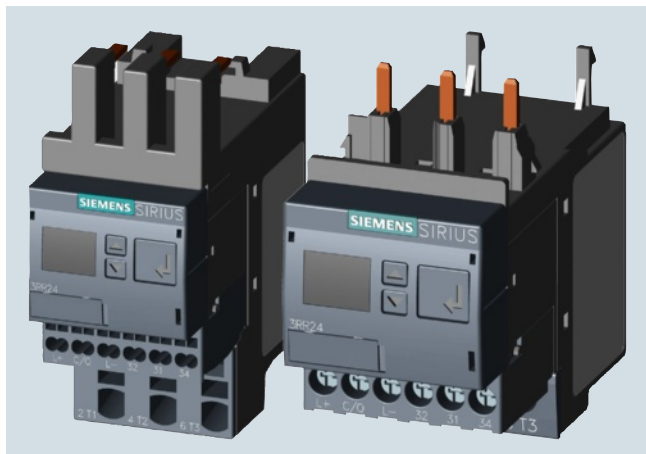

SIRIUS 3RR2441 and 3RR2442 current monitoring relay

The SIRIUS 3RR24 current monitoring relays for IO-Link are suitable for the load monitoring of motors or other loads. In three phases they monitor the rms value of AC currents for overshooting or undershooting of set threshold values.

Whereas apparent current monitoring is used above all in connection with the rated torque or in case of overload, the active current monitoring option, which is also selectable, can be used to observe and evaluate the load factor over a motor's entire torque range.

The 3RR24 current monitoring relays for IO-Link can be integrated directly in the feeder by mounting onto the 3RT2 contactor; separate wiring of the main circuit is therefore superfluous. No separate transformers are required.

For a line-oriented configuration or simultaneous use of an overload relay, terminal supports for stand-alone installation are available for separate standard rail mounting.

The SIRIUS 3RR24 current monitoring relays for IO-Link also offer many other options based upon the monitoring functions of the conventional SIRIUS 3RR2 monitoring relays:

- Measured value transmission to a controller, including resolution and unit, may be parameterizable as to which value is cyclically transmitted
- Transmission of alarm flags to a controller
- Full diagnosis capability by inquiry as to the cause of the fault in the diagnosis data record
- Remote parameterization is also possible, in addition to or instead of local parameterization
- Rapid parameterization of the same devices by duplication of the parameterization in the controller
- Parameter transmission by upload to a controller by IO-Link call or by parameter server (if IO-Link master from IO-Link Specification V 1.1 and higher is used)
- Consistent central data storage in the event of parameter change locally or via a controller
- Automatic reparameterizing when devices are exchanged
- Blocking of local parameterization via IO-Link possible
- Faults are saved in parameterizable and non-volatile fashion to prevent an automatic start-up after voltage failure and to make sure diagnostics data is not lost
- By integration into the automation level the option exists of parameterizing the monitoring relay at any time via a display unit or displaying the measured values in a control room or locally at the machine/control cabinet.

Even without communication via IO-Link the devices continue to function fully autonomously:

- Parameterization can take place locally at the device, independently of a controller.
- In the event of failure or before the controller becomes available the monitoring relays work as long as the control supply voltage (24 V DC) is present.
- If the monitoring relays are operated without the controller, the 3RR24 monitoring relays for IO-Link have, thanks to the integrated SIO mode, an additional semiconductor output, which switches when the adjustable warning threshold is exceeded.

Thanks to the combination of autonomous monitoring relay function and integrated IO-Link communication, redundant sensors and/or analog signal converters – which previously took over the transmission of measured values to a controller, leading to considerable extra cost and wiring outlay – are no longer needed.

Because the output relays are still present, the monitoring relays increase the functional reliability of the system, since the controller can only fulfill the control tasks if the current measured values are available, whereas the output relays can also be used for the disconnection of the system if limit values that cannot be reached during operation are exceeded.

For further information on the IO-Link communication system, see page 5/2 onwards.



## IO-Link

### SIRIUS 3RR24 monitoring relays for mounting onto 3RT2 contactors for IO-Link

#### Current and active current monitoring

##### Benefits

- Can be mounted directly on 3RT2 contactors and 3RA23 reversing contactor assemblies, in other words, there is no need for additional wiring in the main circuit
- Optimally coordinated with the technical characteristics of the 3RT2 contactors
- No separate current transformer required
- Variably adjustable to overshoot, undershoot or range monitoring
- Freely configurable delay times and RESET response
- Display of ACTUAL value and status messages
- All versions with removable control current terminals
- All versions with screw or spring-type terminals
- Simple determination of the threshold values through direct reference to actually measured values for setpoint loading
- Range monitoring and selectable active current measurement mean that only one device for monitoring a motor is required along the entire torque curve
- In addition to current monitoring it is also possible to monitor for current unbalance, broken cables, phase failure, phase sequence, residual current and motor blocking.
- Integrated counter for operating cycles counter and operating hours to support requirements-based maintenance of the monitored machine or application
- Simple cyclical transmission of the current measured values, relay switching states and events to a controller
- Remote parameterization
- Automatic reparameterizing when devices are exchanged
- Simple duplication of identical or similar parameterizations
- Reduction of control current wiring
- Elimination of testing costs and wiring errors
- Reduction of configuration work
- Integration in TIA means clear diagnostics if a fault occurs
- Cost saving and space saving in control cabinet due to the elimination of AI and IO modules as well as analog signal converters and duplicated sensors

##### Application

- Monitoring of current overshoot and undershoot
- Monitoring of broken conductors
- Monitoring of no-load operation and load shedding, e.g. in the event of a torn V-belt or no-load operation of a pump
- Monitoring of overload, e.g. on pumps due to a dirty filter system
- Monitoring the functionality of electrical loads such as heaters
- Monitoring of wrong phase sequence on mobile equipment such as compressors or cranes
- Monitoring of high-impedance short-circuits, e. g. due to damaged insulation or moisture

The use of SIRIUS monitoring relays for IO-Link is particularly recommended for machines and plant in which these relays, in addition to their monitoring function, are to be connected to the automation level for the rapid, simple and fault-free provision of the current measured values and/or for remote parameterization.

The monitoring relays can either relieve the controller of monitoring tasks or, as a second monitoring entity in parallel to and independent of the controller, increase the reliability in the process or in the system. In addition, the elimination of AI and IO modules allows the width of the controller to be reduced despite significantly expanded functionality.





## SIRIUS 3RR24 monitoring relays for mounting onto 3RT2 contactors for IO-Link

## Current and active current monitoring



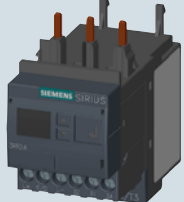
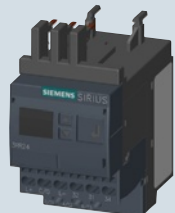





## Selection and ordering data

**SIRIUS 3RR24 current monitoring relays for IO-Link**

- For load monitoring of motors or other loads
- Multi-phase monitoring of undercurrent and overcurrent
- Starting and tripping delay can be adjusted separately
- Tripping delay 0 to 999.9 s
- Auto or Manual RESET

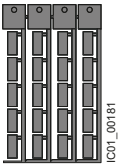
   					
Size	Measuring range	Hysteresis	Control supply voltage $U_s$	Screw terminals 	Spring-type terminals 
	A	A	V	Article No.	Article No.
Digitally adjustable, LCD, open-circuit or closed-circuit principle, 1 CO, 1 semiconductor output (in SIO mode), 3-phase current monitoring, active current or apparent current monitoring, current unbalance monitoring, phase sequence monitoring, residual current monitoring, blocking current monitoring, operating hours counter, operating cycles counter, reclosing delay time 0 ... 999.9 min, start-up delay 0 ... 999.9 s, separate settings for warning and alarm thresholds					
<b>S00</b>	1.6 ... 16	0.1 ... 3	24 DC	<b>3RR2441-1AA40</b>	<b>3RR2441-2AA40</b>
<b>S0</b>	4 ... 40	0.1 ... 8	24 DC	<b>3RR2442-1AA40</b>	<b>3RR2442-2AA40</b>

**IO-Link****SIRIUS 3RR24 monitoring relays for mounting onto 3RT2 contactors for IO-Link****Current and active current monitoring****Accessories**

	Use	Version	Size	Article No.
<b>Terminal supports for stand-alone installation<sup>1)</sup></b>				
 3RU2916-3AA01	For 3RR24	For separate mounting of the overload relays or monitoring relays; screw and snap-on mounting onto TH 35 standard mounting rail according to IEC 60715 <ul style="list-style-type: none"> <li>• Screw connection</li> </ul>	S00	<b>Screw terminals</b>  <b>3RU2916-3AA01</b> <b>3RU2926-3AA01</b>
			S0	
 3RU2926-3AC01	For 3RR24	<ul style="list-style-type: none"> <li>• Spring-type connection</li> </ul>	S00	<b>Spring-type terminals</b>  <b>3RU2916-3AC01</b> <b>3RU2926-3AC01</b>
			S0	
<b>Blank labels</b>				
 3RT2900-1SB20	For 3RR24	<b>Unit labeling plates<sup>2)</sup></b> For SIRIUS devices 20 mm x 7 mm, titanium gray		<b>3RT2900-1SB20</b>
<b>Sealable covers</b>				
 3RR2940	For 3RR24	<b>Sealable covers</b> For securing against unintentional or unauthorized adjustment of settings		<b>3RR2940</b>
<b>Tools for opening spring-type terminals</b>				
 3RA2908-1A	For auxiliary circuit connections	<b>Screwdrivers</b> For all SIRIUS devices with spring-type terminals, 3.0 mm x 0.5 mm, length approx. 200 mm, titanium gray/black, partially insulated		<b>Spring-type terminals</b>  <b>3RA2908-1A</b>

<sup>1)</sup> The accessories are identical to those of the 3RU21 thermal overload relays and the 3RB3 solid-state overload relays, see Catalog IC 10, Chapter 7 "Protection Equipment".

<sup>2)</sup> PC labeling system for individual inscription of unit labeling plates available from: murrplastik Systemtechnik GmbH see Catalog IC 10, Chapter 16, "Appendix" ⇒ "External Partners".

## Overview



SIRIUS 3UG48 monitoring relays

The SIRIUS 3UG4 monitoring relays for electronic and mechanical variables monitor all important characteristics that allow conclusions to be drawn about the functionality of a plant. Both sudden disturbances and gradual changes, which may indicate the need for maintenance, are detected.

Thanks to their relay outputs, the monitoring relays permit direct disconnection of the affected system components as well as alerting e.g. by triggering a warning light. Thanks to adjustable delay times the 3UG4 monitoring relays can respond very flexibly to brief faults such as voltage dips or load changes and can thus avoid unnecessary alarms and disconnections and increase system availability.

### 3UG48 monitoring relays for IO-Link

The SIRIUS 3UG48 monitoring relays for IO-Link also offer many other options based upon the monitoring functions of the tried-and-tested SIRIUS 3UG4 monitoring relays:

- Measured value transmission to a controller, including resolution and unit, may be parameterizable as to which value is cyclically transmitted
- Transmission of alarm flags to a controller
- Full diagnosis capability by inquiry as to the cause of the fault in the diagnosis data record
- Remote parameterization is also possible, in addition to or instead of local parameterization
- Rapid parameterization of the same devices by duplication of the parameterization in the controller
- Parameter transmission by upload to a controller by IO-Link call or by parameter server (if IO-Link master from IO-Link Specification V 1.1 and higher is used)
- Consistent central data storage in the event of parameter change locally or via a controller
- Automatic reparameterizing when devices are exchanged
- Blocking of local parameterization via IO-Link possible
- Faults are saved in parameterizable and non-volatile fashion to prevent an automatic start-up after voltage failure and to make sure diagnostics data is not lost
- Integration into the automation level provides the option of parameterizing the monitoring relays at any time via a display unit, or displaying the measured values in a control room or locally at the machine/control cabinet.

Even without communication via IO-Link the devices continue to function fully autonomously:

- Parameterization can take place locally at the device, independently of a controller.
- In the event of failure or before the controller becomes available the monitoring relays work as long as the control supply voltage (24 V DC) is present.
- If the monitoring relays are operated without the controller, the 3UG48 monitoring relays have, thanks to the integrated SIO mode, an additional semiconductor output, which switches when the adjustable warning threshold is exceeded.

Thanks to the combination of autonomous monitoring relay function and integrated IO-Link communication, redundant sensors and/or analog signal converters – which previously took over the transmission of measured values to a controller, leading to considerable extra cost and wiring outlay – are no longer needed.

Because the output relays are still present, the monitoring relays increase the functional reliability of the system, since the controller can only fulfill the control tasks if the current measured values are available, whereas the output relays can also be used for the disconnection of the system if limit values that cannot be reached during operation are exceeded.

The individual 3UG48 monitoring relays for IO-Link offer the following functions in different combinations:

- Phase sequence
- Phase failure, neutral conductor failure
- Phase asymmetry
- Undershooting and/or overshooting of limit values for voltage
- Undershooting and/or overshooting of limit values for current
- Undershooting and/or overshooting of power factor limit values
- Monitoring of the active current or the apparent current
- Monitoring of the residual current
- Undershooting and/or overshooting of limit values for speed

#### Note:

Further information on the IO-Link bus system see page 5/2 onwards.

#### Notes on safety:

System networking requires suitable protective measures (including network segmentation for IT security) in order to ensure safe plant operation.

More information about the subject of Industrial Security see [www.siemens.com/industrialsecurity](http://www.siemens.com/industrialsecurity).

## IO-Link

### SIRIUS 3UG48 monitoring relays for stand-alone installation for IO-Link

#### General data

#### Overview (continued)

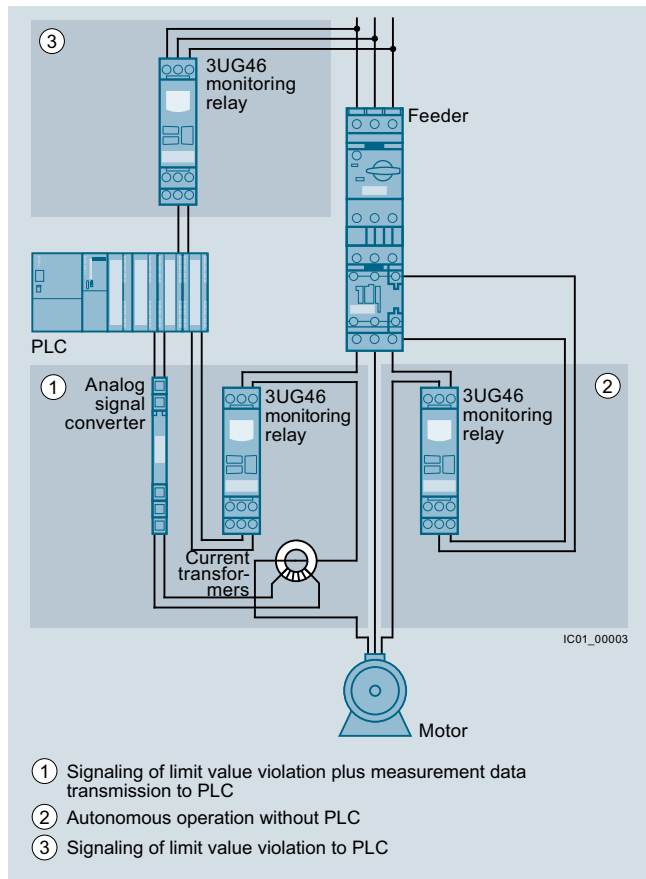

Use of conventional monitoring relays

#### Notes:

Devices required for the communication via IO-Link:

- Any controller that supports the IO-Link (e.g. ET 200S with CPU or S7-1200), see Catalog ST 70 "Products for Totally Integrated Automation"
- IO-Link master (e.g. 4SI or 4SI IO-Link electronic module for SIMATIC ET200S or SM 1278 for S7-1200) see Catalog ST 70 "Products for Totally Integrated Automation"

Each monitoring relay requires an IO-Link channel.

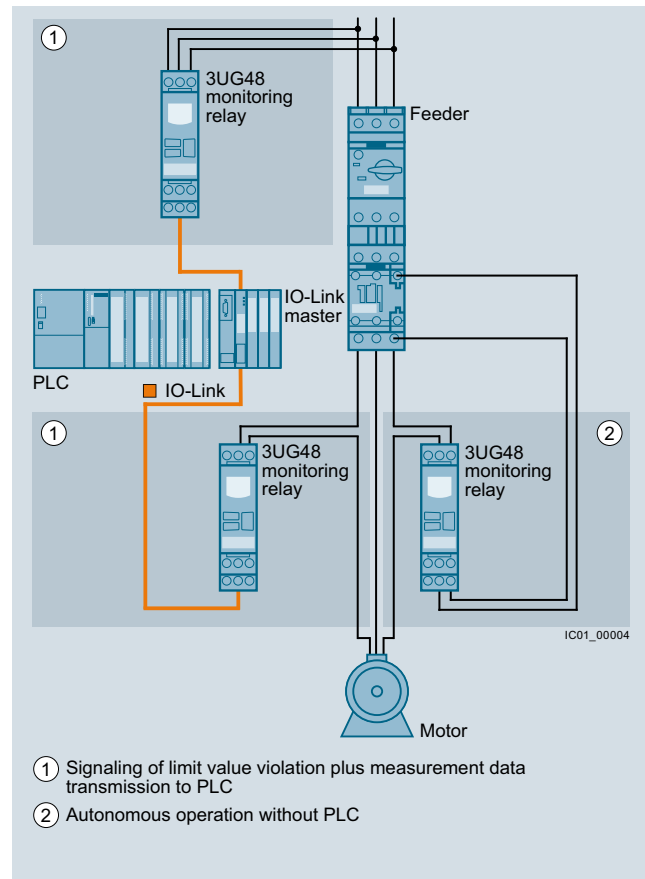

Monitoring relays for IO-Link

#### Connection methods

Selection tables for the 3UG48 monitoring relays can be found on the following pages.

- ⊕ Screw terminals
- ∞ Spring-type terminals

**Benefits**

- Simple cyclical transmission of the current measured values, relay switching states and events to a controller
- Remote parameterization
- Automatic reparameterizing when devices are exchanged
- Simple duplication of identical or similar parameterizations
- Reduction of control current wiring
- Elimination of testing costs and wiring errors
- Reduction of configuration work
- Integration in TIA means clear diagnostics if a fault occurs
- Cost saving and space saving in control cabinet due to the elimination of AI and IO modules as well as analog signal converters and duplicated sensors

**Application**

The use of SIRIUS monitoring relays for IO-Link is particularly recommended for machines and plant in which these relays, in addition to their monitoring function, are to be connected to the automation level for the rapid, simple and fault-free provision of the current measured values and/or for remote parameterization.

The monitoring relays can either relieve the controller of monitoring tasks or, as a second monitoring entity in parallel to and independent of the controller, increase the reliability in the process or in the system. In addition, the elimination of AI and IO modules allows the width of the controller to be reduced despite significantly expanded functionality.

**More information**

Manual "3UG48/3RR24 Monitoring Relays for IO-Link" see <http://support.automation.siemens.com/WW/view/en/54375430>.

**Notes on safety:**

System networking requires suitable protective measures (including network segmentation for IT security) in order to ensure safe plant operation.

More information about the subject of Industrial Security see [www.siemens.com/industrialsecurity](http://www.siemens.com/industrialsecurity).

## IO-Link

### SIRIUS 3UG48 monitoring relays for stand-alone installation for IO-Link

#### Line monitoring

#### Overview

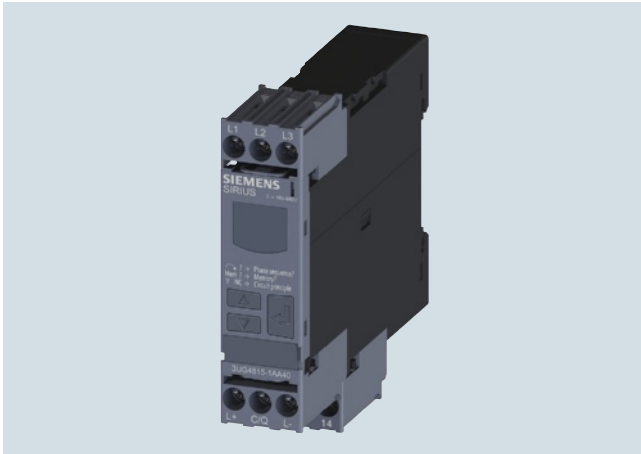

SIRIUS 3UG4815 monitoring relay

Solid-state line monitoring relays provide maximum protection for mobile machines, plants and hoisting equipment or for unstable networks. Network and voltage faults can thus be detected early and rectified before far greater damage ensues.

The line monitoring relays with IO-Link monitor phase sequence, phase failure (with or without N conductor monitoring), phase asymmetry and undervoltage and/or overvoltage.

Phase asymmetry is evaluated as the difference between the greatest and the smallest phase voltage relative to the greatest phase voltage. Undervoltage or overvoltage exist if the set limit values for at least one phase voltage are overshot or undershot. The rms value of the voltage is measured.

#### Benefits

- Can be used in any network from 160 to 630 V AC worldwide thanks to wide voltage range
- Variably adjustable to overshoot, undershoot or range monitoring
- Freely configurable delay times and RESET response
- Width 22.5 mm
- Display and transmission of actual value and network fault type to controller
- All versions with removable terminals
- All versions with screw or spring-type terminals

#### Application

The relays are used above all for mobile equipment, e.g. air conditioning compressors, refrigerating containers, building site compressors and cranes.

Function	Application
Phase sequence	• Direction of rotation of the drive
Phase failure	• A fuse has tripped • Failure of the control supply voltage • Broken cable
Phase asymmetry	• Overheating of the motor due to asymmetrical voltage • Detection of asymmetrically loaded networks
Undervoltage	• Increased current on a motor with corresponding overheating • Unintentional resetting of a device • Network collapse, particularly with battery power
Overvoltage	• Protection of a plant against destruction due to overvoltage

#### Selection and ordering data

- Adjustable via IO-Link and locally, with illuminated LCD
- Power supply with 24 V DC via IO-Link or external auxiliary voltage
- Auto or Manual RESET
- Open or closed-circuit principle
- 1 CO contact, 1 semiconductor output (in SIO mode)

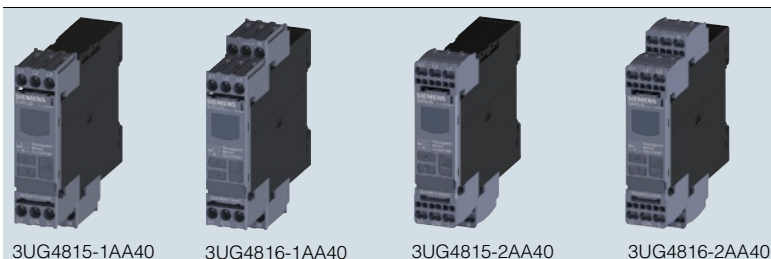

3UG4815-1AA40	3UG4816-1AA40	3UG4815-2AA40	3UG4816-2AA40	Adjustable hysteresis	Under-voltage detection	Over-voltage detection	Stabilization time adjustable sDEL	Tripping delay time adjustable Del	Version of auxiliary contacts	Measurable mains voltage <sup>1)</sup>	Screw terminals	Spring-type terminals
				V			s	s		V AC	Article No.	Article No.

#### Monitoring of phase sequence, phase failure, phase asymmetry, overvoltage and undervoltage

1 ... 20	✓	✓	0.1 ... 999.9	0.1 ... 999.9	1 CO + 1 Q <sup>2)</sup>	160 ... 690	<b>3UG4815-1AA40</b>	<b>3UG4815-2AA40</b>
----------	---	---	---------------	---------------	--------------------------	-------------	----------------------	----------------------

#### Monitoring of phase sequence, phase and N conductor failure, phase asymmetry, overvoltage and undervoltage

1 ... 20	✓	✓	0.1 ... 999.9	0.1 ... 999.9	1 CO + 1 Q <sup>2)</sup>	90 ... 400 to N	<b>3UG4816-1AA40</b>	<b>3UG4816-2AA40</b>
----------	---	---	---------------	---------------	--------------------------	-----------------	----------------------	----------------------

✓ Function available

<sup>1)</sup> Absolute limit values.

<sup>2)</sup> In SIO mode.

For accessories see page 5/53.



## Overview

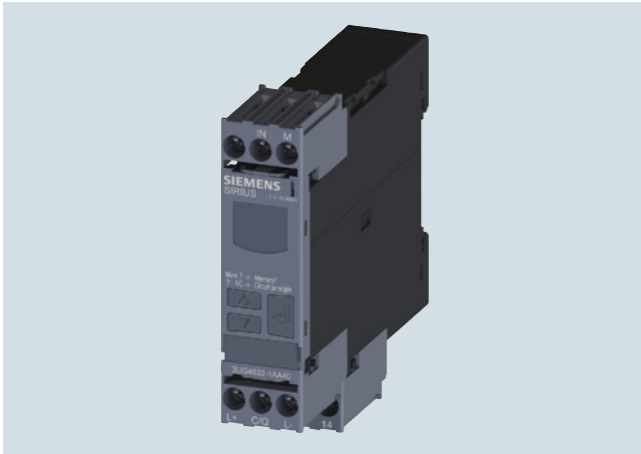

SIRIUS 3UG4832 monitoring relays

The relays monitor single-phase AC voltages (rms value) and DC voltages against the set limit value for overshoot and under-shoot.

## Benefits



- Variably adjustable to overshoot, undershoot or range monitoring
- Freely configurable delay times and RESET response
- Width 22.5 mm
- Display and transmission of actual value and status messages to controller
- All versions with removable terminals
- All versions with screw or spring-type terminals

## Application

- Protection of a plant against destruction due to overvoltage
- Switch-on of a plant at a defined voltage and higher
- Protection from undervoltage due to overloaded control supply voltages, particularly with battery power

## Selection and ordering data

- Adjustable via IO-Link and locally, with illuminated LCD
- Power supply with 24 V DC via IO-Link or external auxiliary voltage
- Auto or Manual RESET
- Open or closed-circuit principle
- 1 CO contact, 1 semiconductor output (in SIO mode)

Measuring range	Adjustable hysteresis	ON-delay time adjustable onDel	Tripping delay time separately adjustable U▲Del/U▼Del	3UG4832-1AA40	3UG4832-2AA40
V AC/DC	V	s	s	<b>Screw terminals</b> 	<b>Spring-type terminals</b> 
<b>Monitoring of voltage for overshoot and undershoot</b>				<b>Article No.</b>	<b>Article No.</b>
10 ... 600	0.1 ... 300	0 ... 999.9	0 ... 999.9	<b>3UG4832-1AA40</b>	<b>3UG4832-2AA40</b>

For accessories see page 5/53.

**IO-Link**

## SIRIUS 3UG48 monitoring relays for stand-alone installation for IO-Link

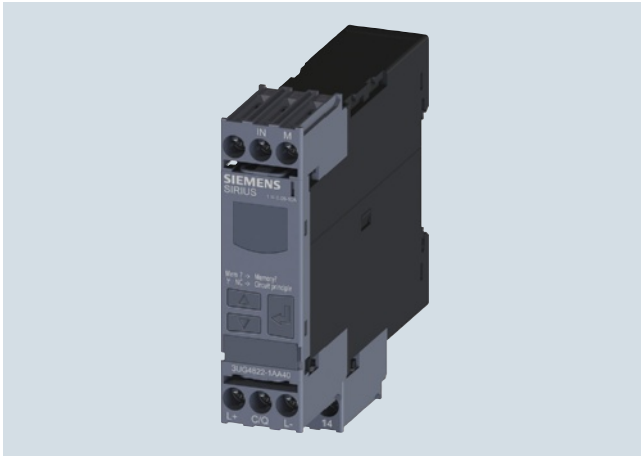
**Current monitoring****Overview**

SIRIUS 3UG4822 monitoring relays

The relays monitor single-phase AC (rms value) and DC currents against the set limit value for overshoot and undershoot.

**Benefits**

- Variably adjustable to overshoot, undershoot or range monitoring
- Freely configurable delay times and RESET response
- Width 22.5 mm
- Display and transmission of actual value and status messages to controller
- All versions with removable terminals
- All versions with screw or spring-type terminals

**Application**

- Overcurrent and undercurrent monitoring
- Monitoring the functionality of electrical loads
- Monitoring for broken conductors

**Selection and ordering data**



- Adjustable via IO-Link and locally, with illuminated LCD
- Power supply with 24 V DC via IO-Link or external auxiliary voltage
- Adjustable converter factor to display the measured primary current when external current transformer used
- Auto or Manual RESET
- Open or closed-circuit principle
- 1 CO contact, 1 semiconductor output (in SIO mode)



3UG4822-1AA40



3UG4822-2AA40

Measuring range	Adjustable hysteresis	ON-delay time adjustable onDel	Tripping delay time separately adjustable U▲Del/L▼Del	Screw terminals 	Spring-type terminals 
AC/DC A	A	s	s	Article No.	Article No.

**Monitoring of current for overshooting and undershooting**

0.05 ... 10	0.01 ... 5	0.1 ... 999.9	0.1 ... 999.9	<b>3UG4822-1AA40</b>	<b>3UG4822-2AA40</b>
-------------	------------	---------------	---------------	----------------------	----------------------

For accessories see page 5/53.

For AC currents  $I > 10$  A it is possible to use commercially available current transformers, e.g. the Siemens 4NC current transformer, as accessories, see Catalog LV 10, "Low-Voltage Power Distribution and Electrical Installation Technology".

## Overview

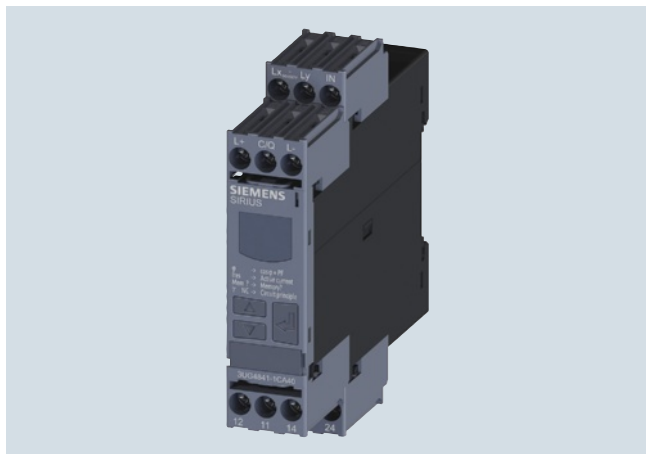

SIRIUS 3UG4841 monitoring relay

The 3UG4841 power factor and active current monitoring devices enable the load monitoring of motors.

Whereas power factor monitoring is used above all for monitoring no-load operation, the active current monitoring option can be used to observe and evaluate the load factor over the entire torque range.

## Benefits

- Monitoring of even small single-phase motors with a no-load supply current below 0.5 A
- Simple determination of threshold values by the direct collection of measured variables on motor loading
- Range monitoring and active current measurement enable detection of cable breaks between control cabinets and motors, as well as phase failures
- Power factor and/or  $I_{res}$  (active current) can be selected as the measurement principle
- Width 22.5 mm
- Display and transmission of actual value and status messages to controller
- All versions with removable terminals
- All versions with screw or spring-type terminals

## Application

- No-load monitoring and load shedding, such as in the event of a V-belt tear
- Underload monitoring in the low performance range, e.g. in the event of pump no-load operation
- Monitoring of overload, e.g. due to a dirty filter system
- Power factor monitoring in networks for control of compensation equipment
- Broken cable between control cabinet and motor

## Selection and ordering data

- For monitoring the power factor  $\varphi$  and the active current  $I_{res}$
- Suitable for single- and three-phase currents
- Adjustable via IO-Link and locally, with illuminated LCD
- Power supply with 24 V DC via IO-Link or external auxiliary voltage
- Overshoot, undershoot or range monitoring adjustable
- Upper and lower limit values can be adjusted separately
- Permanent display of actual value and tripping state
- 1 CO contact each for undershoot and overshoot, 1 semiconductor output (in SIO mode)



3UG4841-1CA40



3UG4841-2CA40

Measuring range		Voltage range of the measuring voltage <sup>1)</sup>	Hysteresis		ON-delay time adjustable onDel	Tripping delay time adjustable $U\blacktriangle\text{Del}/U\blacktriangledown\text{Del}$ , $\varphi\blacktriangle\text{Del}/\varphi\blacktriangledown\text{Del}$	Screw terminals	Spring-type terminals
For power factor	For active current $I_{res}$		Adjustable for power factor	Adjustable for active current $I_{res}$			Article No.	Article No.
P.f.	A	V	P.f.	A	s	s		

### Monitoring of power factor and active current for overshooting and undershooting

0.1 ... 0.99    0.2 ... 10    90 ... 690    0.1 ... 0.2    0.1 ... 3    0 ... 999.9    0 ... 999.9

**3UG4841-1CA40**

**3UG4841-2CA40**

<sup>1)</sup> Absolute limit values.

For accessories see page 5/53.

For AC active currents  $I_{res} > 10$  A it is possible to use commercially available current transformers, e.g. Siemens 4NC current converter, as accessories, see Catalog LV 10 "Low-Voltage Power Distribution and Electrical Installation Technology".

## IO-Link

SIRIUS 3UG48 monitoring relays for stand-alone installation for IO-Link  
Residual current monitoring

### Residual-current monitoring relays

#### Overview



SIRIUS 3UG4825 monitoring relay

The 3UG4825 residual-current monitoring relays are used in conjunction with the 3UL23 residual current transformers for monitoring plants in which higher residual currents are increasingly expected due to environmental conditions. Monitoring encompasses pure AC residual currents or AC residual currents with a pulsating DC fault current component (transformer type A in accordance with DIN VDE 0100-530/IEC TR 60755).

#### Benefits





- High measuring accuracy  $\pm 7.5\%$
- Permanent self-monitoring
- Parameterization of the devices locally or via IO-Link possible
- Variable threshold values for warning and disconnection
- Freely configurable delay times and RESET response
- Display and transmission of actual value and status messages to controller
- High level of flexibility and space saving through installation of the transformer inside or outside the control cabinet
- Width 22.5 mm
- All versions with removable terminals
- All versions with screw or spring-type terminals

#### Application

Monitoring of plants in which residual currents can occur, e.g. due to dust deposits or moisture, porous cables and leads, or capacitive residual currents

#### Selection and ordering data

- For monitoring residual currents from 0.03 to 40 A, from 16 to 400 Hz
- For 3UL23 residual-current transformers with feed-through opening from 35 to 210 mm
- Permanent self-monitoring
- Certified in accordance with IEC 60947, functionality corresponds to IEC 62020
- Digitally adjustable, with illuminated LCD
- Permanent display of actual value and tripping state
- Separately adjustable limit value and warning threshold
- 1 changeover contact each for warning threshold and tripping threshold

						
					3UG4825-1CA40	3UG4825-2CA40
Measurable current	Adjustable response value current	Switching hysteresis	Adjustable response delay time	Control supply voltage At DC, rated value	<b>Screw terminals</b> 	<b>Spring-type terminals</b> 
A	A	%	s	V	<b>Article No.</b>	<b>Article No.</b>
0.01 ... 43	0.03 ... 40	0 ... 50	0 ... 999.9	24	<b>3UG4825-1CA40</b>	<b>3UG4825-2CA40</b>

For accessories see page 5/53.

3UL23 residual-current transformers and accessories for 3UL23 see page 5/51.

SIRIUS 3UG48 monitoring relays for stand-alone installation for IO-Link  
Residual current monitoring

## 3UL23 residual-current transformers

## Overview



SIRIUS 3UL23 residual-current transformer

The 3UL23 residual-current transformers detect residual currents in machines and plants. They are suitable for pure AC residual currents or AC residual currents with a pulsating DC fault current component (transformer type A in accordance with DIN VDE 0100-530/IEC TR 60755).

Together with the 3UG4625, 3UG4825 residual-current monitoring relays for IO-Link or the SIMOCODE 3UF motor management and control device they enable residual-current and ground-fault monitoring.

The 3UL2302-1A and 3UL2303-1A residual-current transformers with a feed-through opening from 35 to 55 mm can be mounted in conjunction with the 3UL2900 accessories on a TH 35 standard mounting rail according to IEC 60715.

## Selection and ordering data

Diameter of the feed-through opening mm	Connectable cross-section of the connecting terminal mm <sup>2</sup>	Screw terminals Article No.
<i>Residual-current transformer (essential accessory for 3UG4625, 3UG4825 or SIMOCODE 3UF)</i>		
35	2.5	3UL2302-1A
55	2.5	3UL2303-1A
80	2.5	3UL2304-1A
110	2.5	3UL2305-1A
140	2.5	3UL2306-1A
210	4	3UL2307-1A

## Accessories

Version	Article No.
<b>Adapter</b>  <b>Adapter</b> For mounting onto standard rail for 3UL23 to diameter 55 mm	3UL2900

3UL2900

## IO-Link

### SIRIUS 3UG48 monitoring relays for stand-alone installation for IO-Link

#### Speed monitoring

##### Overview



SIRIUS 3UG4851 monitoring relay

3UG4851 monitoring relays are used in combination with a sensor to monitor drives for overspeed and/or underspeed.

Furthermore, the monitoring relays are ideal for all functions where a continuous pulse signal needs to be monitored (e.g. belt travel monitoring, completeness monitoring, passing monitoring, clock-time monitoring).

##### Benefits

- Variably adjustable to overshoot, undershoot or range monitoring
- Freely configurable delay times and RESET response
- Display and transmission of actual value and fault type to controller
- Use of up to 10 sensors per rotation for extremely slowly rotating motors
- 2- or 3-wire sensors and sensors with a mechanical switching output or solid-state-output can be connected
- Auxiliary voltage for sensor integrated
- All versions with removable terminals
- All versions with screw or spring-type terminals

##### Application

- Slip or tear of a belt drive
- Overload monitoring
- Transport monitoring for completeness

5

##### Selection and ordering data

- For speed monitoring in revolutions per minute (rpm)
- Two- or three-wire sensor with mechanical or electronic switching output can be connected
- Two-wire NAMUR sensor can be connected
- Sensor supply 24 V DC/50 mA integrated
- Input frequency 0.1 to 2 200 pulses per minute (0.0017 to 36.7 Hz)
- With or without enable signal for the drive to be monitored
- Adjustable via IO-Link and locally, with illuminated LCD
- Power supply with 24 V DC via IO-Link or external auxiliary voltage
- Overshoot, undershoot or range monitoring adjustable
- Number of pulses per revolution can be adjusted
- Upper and lower limit values can be adjusted separately
- Auto, manual or remote RESET options after tripping
- Permanent display of actual value and tripping state
- 1 CO contact, 1 semiconductor output (in SIO mode)



3UG4851-1AA40



3UG4851-2AA40

Measuring range	Adjustable hysteresis	ON-delay time adjustable onDel	Tripping delay time separately adjustable rpm▲Del/rpm▼Del	Pulses per revolution	Screw terminals	Spring-type terminals
rpm	rpm	s	s		Article No.	Article No.

##### Speed monitoring for overshooting and undershooting



0.1 ... 2 200	OFF 1 ... 99.9	0 ... 999.9	0 ... 999.9	1 ... 10
---------------	-------------------	-------------	-------------	----------

**3UG4851-1AA40**

**3UG4851-2AA40**

For accessories see page 5/53.

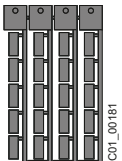
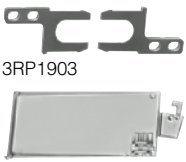
## Selection and ordering data

	Use	Version	Article No.
<b>Blank labels</b>			
 3RT29 00-1SB20	For 3UG48	<b>Unit labeling plates</b> For SIRIUS devices 20 mm x 7 mm, titanium gray <sup>1)</sup>	<b>3RT29 00-1SB20</b>
	For 3UG48	<b>Adhesive labels</b> For SIRIUS devices 19 mm x 6 mm, pastel turquoise 19 mm x 6 mm, zinc yellow	<b>3RT1900-1SB60</b> <b>3RT1900-1SD60</b>
<b>Push-in lugs and covers</b>			
 3RP1903 3RP1902	For 3UG48	<b>Push-in lugs</b> For screw fixing, 2 units are required for each device	<b>3RP1903</b>
	For 3UG48	<b>Sealable covers</b> For securing against unauthorized adjustment of setting knobs	<b>3RP1902</b>
<b>Tools for opening spring-type terminals</b>			
 3RA2908-1A	For auxiliary circuit connections	<b>Screwdrivers</b> For all SIRIUS devices with spring-type terminals 3.0 mm x 0.5 mm, length approx. 200 mm, titanium gray/black, partially insulated	<b>Spring-type terminals</b>  <b>3RA2908-1A</b>

<sup>1)</sup> PC labeling system for individual inscription of unit labeling plates available from: murrplastik Systemtechnik GmbH see Catalog IC 10, Chapter 16, "Appendix" ⇒ "External Partners".



## IO-Link

### SIRIUS 3RS14, 3RS15 temperature monitoring relays for IO-Link

#### General data

#### Overview



SIRIUS 3RS14, 3RS15 temperature monitoring relay

The temperature monitoring relays for IO-Link are used to measure temperatures in solid, liquid and gas media.

The temperature is calculated using a sensor in the medium, evaluated by the device and monitored up to two limit values for overshooting or undershooting a working range (window function).

In addition to warnings and disconnection in case of temperature deviations, the devices can also be used as a temperature controller (one-point, two-point or three-point control).

The devices differ from one another in terms of the type and number of connectable temperature sensors.

- 3RS14: Connection for resistance sensor
- 3RS15: Connection for thermocouples

Function	Temperature monitoring relays		
	3RS1440	3RS1441	3RS1540
<b>Connectable sensor type</b>			
Number of sensors monitored	1	3	1
Resistance sensor	✓	✓	--
Thermocouples	--	--	✓
<b>Temperature monitoring</b>			
Temperature monitoring - overshoot	✓	✓	✓
Temperature monitoring - undershoot	✓	✓	✓
Number of adjustable limit values	2	2	2

✓ Function supported

-- Function not supported

5

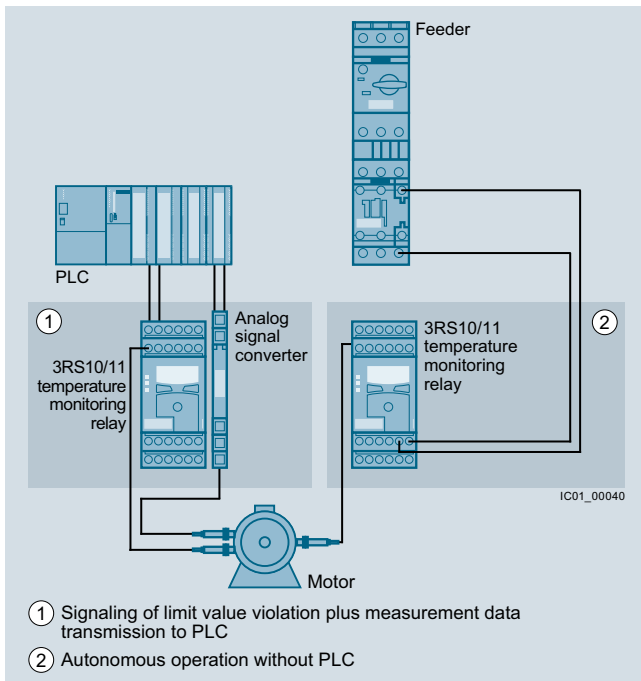

Conventional temperature monitoring relays

#### Notes:

Devices required for the communication via IO-Link:

- Any controller that supports the IO-Link (e.g. ET 200S with CPU or S7-1200), see Catalog ST 70 "Products for Totally Integrated Automation"
- IO-Link master (e.g. 4SI or 4SI IO-Link electronic module for SIMATIC ET 200S or SM 1278 for S7-1200) see Catalog ST 70 "Products for Totally Integrated Automation"

Each monitoring relay requires an IO-Link channel.

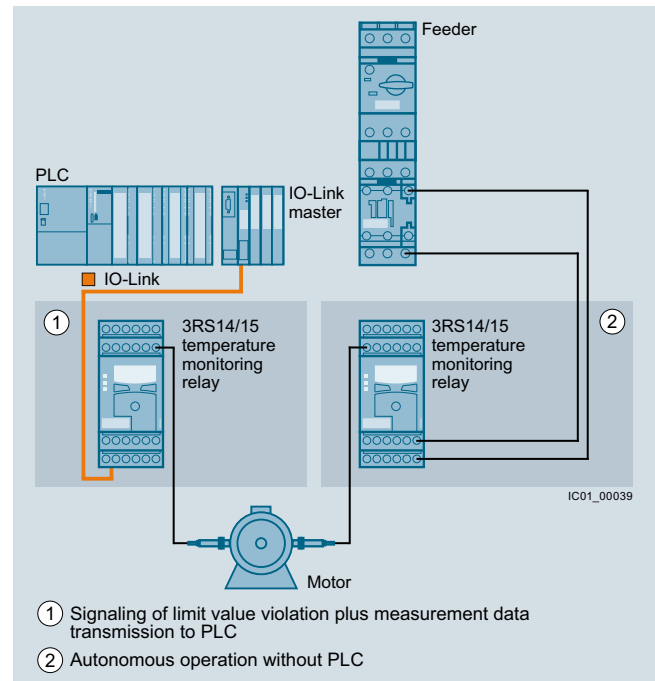

Temperature monitoring relays for IO-Link



#### Notes on safety:

System networking requires suitable protective measures (including network segmentation for IT security) in order to ensure safe plant operation.

More information about the subject of Industrial Security see [www.siemens.com/industrialsecurity](http://www.siemens.com/industrialsecurity).

**Overview** (continued)**Connection methods**

Selection tables for the 3RS14 and 3RS15 monitoring relays can be found on the following pages.

-  Screw terminals
-  Spring-type terminals

**More information****Characteristic curves**

For resistance sensors

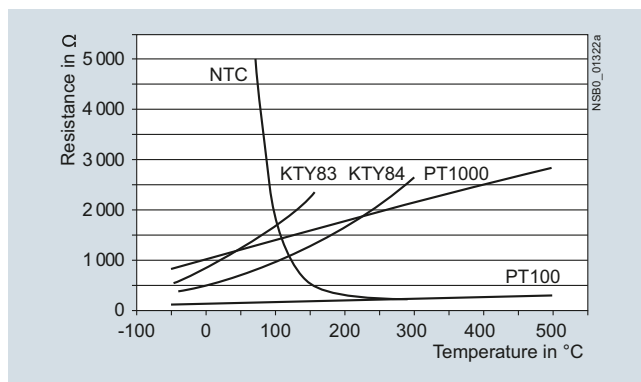

The short-circuit and open-circuit detection as well as the measuring range is limited, depending on the sensor type.

## Measuring ranges for resistance sensors

Sensor type	Short circuit	Open circuit	3RS1440, 3RS1441	
			Measuring range in °C	Measuring range in °F
PT100	✓	✓	-50 ... +750	-58 ... +1 382
PT1000	✓	✓	-50 ... +500	-58 ... +932
KTY83-110	✓	✓	-50 ... +175	-58 ... +347
KTY84	✓	✓	-40 ... +300	-40 ... +572
NTC <sup>1)</sup>	✓	--	+80 ... +160	+176 ... +320

- ✓ Detection possible
- Detection not possible

<sup>1)</sup> NTC type: B57227-K333-A1 (100 °C: 1.8 kΩ; 25 °C: 32.762 kΩ).

For thermocouples

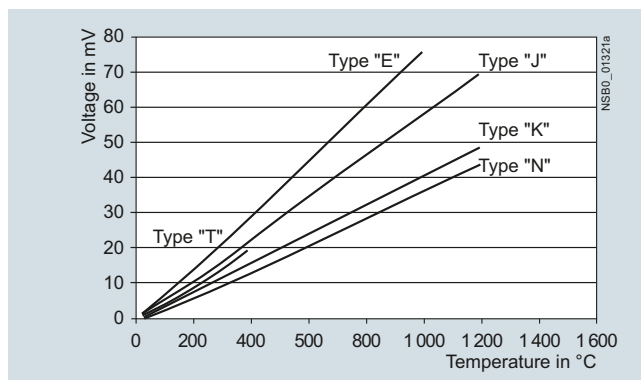

Characteristic curves for sensor types K, N, J, E and T

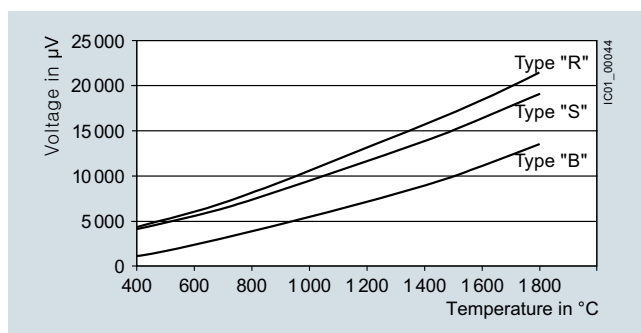

Characteristic curves for sensor types S, R and B

## Measuring ranges for thermocouples

Sensor type	Short circuit	Open circuit	3RS1540	
			Measuring range in °C	Measuring range in °F
K	--	✓	-99 ... +1 350	-146.2 ... +2 462
N	--	✓	-99 ... +1 300	-146.2 ... +2 372
J	--	✓	-99 ... +1 200	-146.2 ... +2 192
E	--	✓	-99 ... +999	-146.2 ... +1 830.2
T	--	✓	-99 ... +400	-146.2 ... +752
S	--	✓	0 ... 1 750	32 ... 3 182
R	--	✓	0 ... 1 750	32 ... 3 182
B	--	✓	400 ... 1 800	752 ... 3 272

- ✓ Detection possible
- Detection not possible

**Note:**

For the manual "3RS14/3RS15 Temperature Monitoring Relays for IO-Link", see <http://support.automation.siemens.com/WW/view/en/54375463>.

## IO-Link

### SIRIUS 3RS14, 3RS15 temperature monitoring relays for IO-Link

#### Relays, digitally adjustable for 1 sensor

#### Overview

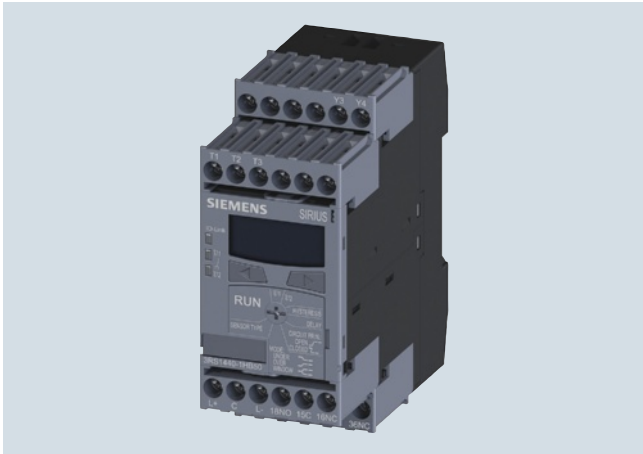

SIRIUS 3RS1440 digital monitoring relay for 1 sensor

The 3RS14 and 3RS15 temperature monitoring relays for IO-Link are used to measure temperatures in solid, liquid and gas media. The temperature is calculated using a sensor in the medium, evaluated by the device and monitored for overshooting or undershooting a working range (window function). The digital temperature monitoring relays have two separately adjustable limit values, are non-volatile and can be operated as desired using the open- or closed-circuit principle.

The devices differ in terms of the number of temperature sensors which can be evaluated. The 3RS1440 and 3RS1540 for IO-Link temperature monitoring relays can be digitally adjusted for one sensor and represent an alternative to temperature controllers in the low-end range (two-point or three-point control).

The devices with two-point control can, for example, be used as a thermostat. The devices with three-point control can, for example, independently switch between heating and cooling.

The 3RS1441 temperature monitoring relays for IO-Link can be digitally adjusted to evaluate up to three resistance sensors at one time. The devices were designed specifically for monitoring motor windings and positions.

The temperature monitoring relays are powered through the control supply voltages IO-Link (L+) and ground (L-) or via an external 24 V DC power supply.

#### Monitoring

When the temperature has reached the  $\vartheta_1$  limit value, the K1 output relay changes its switching state after the configured time  $t$  has expired (output relay K2 reacts accordingly at  $\vartheta_2$ ). The delay time can be adjusted.

The output relays return immediately to their original state once the temperature reaches the respective hysteresis value.

When the temperature has reached the top  $\vartheta_1$  limit value, the K1 output relay changes its switching state after the configured time  $t$  has expired. The output relay returns immediately to its original state once the temperature reaches the respective hysteresis value.

The K2 output relay reacts in the same way at the  $\vartheta_2$  lower threshold. Both limit values  $\vartheta_1$  and  $\vartheta_2$  can be parameterized for overshooting or undershooting the thresholds. This makes it possible to use a limit value for issuing an alarm signal to announce that a limit value is about to be overshoot or undershoot.

#### Note:

The "Temperature monitoring mode" parameter can be used to set the desired type of monitoring (monitoring for overshooting or undershooting or range monitoring).

#### Benefits

- Very simple operation without complicated menu selections
- Two- or three-point control can be parameterized quickly
- All versions with removable terminals
- All versions with screw or spring-type terminals







#### Application

The temperature monitoring relays can be used in almost any application in which temperature overshoot or undershoot is not permitted, e.g. in the monitoring of set temperature limits and the output of alarm messages for:

- Plant and environment protection
- Temperature limits for process variables e.g. in the packaging industry or electroplating
- Temperature limits for district heating plants
- Exhaust temperature monitoring
- Controlling equipment and machines such as heating, climate and ventilation systems, solar collectors, heat pumps or warm water supplies
- Motor, bearing and gear oil monitoring
- Monitoring of coolants

**Selection and ordering data**

- To monitor temperatures with a resistance sensor or thermocouple
- Temperature range dependent on sensor type  
-99 to +1 800 °C or -146.2 to +3 272 °F
- Short-circuit and open-circuit detection in sensor circuit
- Adjustable via IO-Link and locally, with illuminated LCD
- Power supply with 24 V DC via IO-Link or external auxiliary voltage
- Overshoot, undershoot or range monitoring adjustable
- Exact sensor type can be set
- 2 limit values, can be adjusted separately
- Adjustable open/closed-circuit principle
- Can be adjusted by hand or remote RESET (via an external contact)
- Actual value, tripping state for control displayed and conveyed, adjustable in °C or °F
- 1 CO contact per limit value
- 1 CO contact for monitoring sensors and devices

						
3RS1440-1HB50	3RS1540-1HB80	3RS1440-2HB50	3RS1540-2HB80			
Sensors	Measuring range (limit of measuring range dependent on sensor)	Hysteresis adjustable for §1 and §2	Tripping delay time adjustable for §1 and §2 DELAY	Control supply voltage $U_s$	<b>Screw terminals</b> 	<b>Spring-type terminals</b> 
		K	s	V DC	<b>Article No.</b>	<b>Article No.</b>

**Temperature monitoring relay, digitally adjustable for a sensor, non-volatile fault storage can be selected**

PT100/PT1000, KTY83/KTY84, NTC (resistance sensor) <sup>1)</sup>	-50 ... +750 °C or -58 ... +1 382 °F	0 ... 99	0 ... + 999.9	24	<b>3RS1440-1HB50</b>	<b>3RS1440-2HB50</b>
Type B, E, J, K, N, R, S, T (thermocouples)	- 99 ... + 1 800 °C or - 146.2 ... + 3 272 °F	0 ... 99	0 ... + 999.9	24	<b>3RS1540-1HB80</b>	<b>3RS1540-2HB80</b>

<sup>1)</sup> NTC type B57227-K333-A1 (100 °C: 1.8 k $\Omega$ ; 25 °C: 32.762 k $\Omega$ ).

For accessories see page 5/59.

## IO-Link

### SIRIUS 3RS14, 3RS15 temperature monitoring relays for IO-Link

#### Relays, digitally adjustable for up to 3 sensors

#### Overview

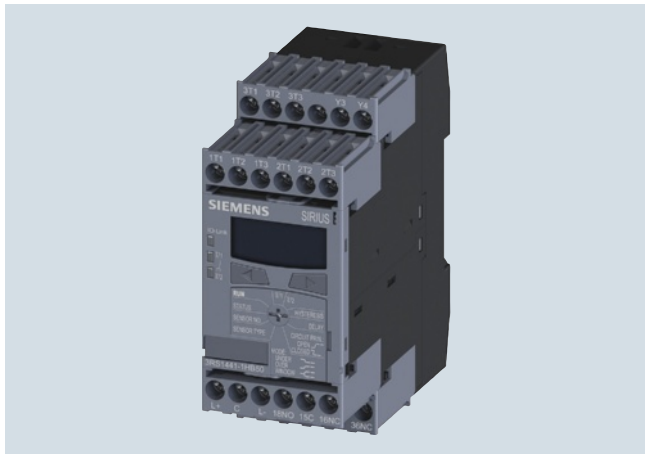

SIRIUS 3RS1441 digital temperature monitoring relay for up to 3 sensors

The 3RS14 temperature monitoring relays can be used to measure temperatures in solid, liquid and gas media. The temperature is calculated using a sensor in the medium, evaluated by the device and monitored for overshooting or undershooting a working range (window function). The devices can be parameterized to indicate the measured temperature in °C or °F. The 3RS1441 evaluation unit can evaluate up to 3 resistance sensors at the same time.

#### Benefits

- Very simple operation without complicated menu selections
- Space-saving with 45 mm width
- Two- or three-point control can be parameterized quickly
- All versions with removable terminals
- All versions with screw or spring-type terminals

#### Application

The 3RS1441 temperature monitoring relays can be used almost anywhere where several temperatures must be monitored at one time for overshooting, undershooting or staying within a certain range.

Monitoring of set temperature limits and output of alarm messages for:

- Plant and environment protection
- Temperature limits for process variables e.g. in the packaging industry or electroplating
- Controlling equipment and machines such as heating, climate and ventilation systems, solar collectors, heat pumps or warm water supplies
- Motor, bearing and gear oil monitoring
- Monitoring of coolants

#### Selection and ordering data



- For temperature monitoring with up to 3 resistance sensors
- Temperature range dependent on sensor type  
-50 to +750 °C or -58 to +1 382 °F
- Short-circuit and open-circuit detection in sensor circuit
- Adjustable via IO-Link and locally, with illuminated LCD
- Power supply with 24 V DC via IO-Link or external auxiliary voltage
- Overshoot, undershoot or range monitoring adjustable
- Exact sensor type and number of sensors can be set
- 2 limit values, can be adjusted separately
- Adjustable open/closed-circuit principle
- Can be adjusted by hand or remote RESET (via an external contact)
- Actual value, tripping state for control displayed and conveyed, adjustable in °C or °F
- 1 CO contact per limit value
- 1 CO contact for monitoring sensors and devices



3RS1441-1HB50



3RS1441-2HB50

Sensors	Number of sensors that can be set	Measuring range (limit of measuring range dependent on sensor)	Hysteresis adjustable for 91 and 92	Tripping delay time adjustable for 91 and 92 DELAY	Control supply voltage $U_s$	Screw terminals 	Spring-type terminals 
			K	s	V DC	<b>Article No.</b>	<b>Article No.</b>





**Temperature monitoring relay, digitally adjustable for up to 3 sensors, non-volatile fault storage can be selected**

PT100/PT1000, KTY83/KTY84, NTC (resistance sensor) <sup>1)</sup>	1 ... 3 sensors	- 50 ... +750 °C or -58 ... +1 382 °F	0 ... 99	0 ... + 999.9	24	<b>3RS1441-1HB50</b>	<b>3RS1441-2HB50</b>
---	--------------------	--	----------	---------------	----	----------------------	----------------------

<sup>1)</sup> NTC type: B57227-K333-A1 (100 °C: 1.8 kΩ; 25 °C: 32.762 kΩ).

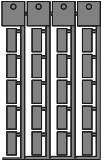
For accessories see page 5/59.

## Selection and ordering data

	Use	Version	Article No.
<b>Blank labels</b>			
 3RT2900-1SB20	For 3RS14 and 3RS15	<b>Unit labeling plates</b> For SIRIUS devices 20 mm x 7 mm, titanium gray <sup>1)</sup>	<b>3RT2900-1SB20</b>
	For 3RS14 and 3RS15	<b>Adhesive labels</b> for SIRIUS devices  19 mm x 6 mm, pastel turquoise 19 mm x 6 mm, zinc yellow	<b>3RT1900-1SB60</b> <b>3RT1900-1SD60</b>
	<b>Push-in lugs and covers</b>		
 3RP1903	For 3RS14 and 3RS15	<b>Push-in lugs</b> For screw fixing, 2 units are required for each device	<b>3RP1903</b>
	For 3RS14 and 3RS15	<b>Sealing foil</b> For securing against unauthorized adjustment of setting knobs	<b>3TK2820-0AA00</b>
<b>Tools for opening spring-type terminals</b>			
 3RA2908-1A	For auxiliary circuit connections	<b>Screwdrivers</b> For all SIRIUS devices with spring-type terminals  3.0 mm x 0.5 mm, length approx. 200 mm, titanium gray/black, partially insulated	<b>Spring-type terminals</b> 

<sup>1)</sup> PC labeling system for individual inscription of unit labeling plates available from: murrplastik Systemtechnik GmbH see Catalog IC 10, Chapter 16, "Appendix" ⇒ "External Partners".

Matching sensors see [www.siemens.com/temperature](http://www.siemens.com/temperature).

## IO-Link RFID Systems

### Introduction

### Overview



The SIMATIC RF200 is the compact RFID system in accordance with ISO 15693 within the SIMATIC RF product family. This system comprises space-saving HF readers (13.45 MHz), which are especially suitable for applications in intralogistics or in small assembly lines.

The readers SIMATIC RF210R, RF220R and RF260R with the interface variant for IO-Link support very simple identification tasks, such as reading an identification number or any user data ("Read Only"). This standardized interface makes it particularly easy and cost-effective to link the data automatically read by the reader into the automation level.

The comprehensive portfolio of extremely rugged, industry-compatible ISO 15693 data carriers from Siemens is available for a wide range of application areas: low-cost Smart Labels for permanent attachment to the product, screw-type transponders for easy mounting (also by robots), or transponders for flush-mounting in metal, for example, on a workpiece carrier.

**Overview**

SIMATIC RF210R is an M18 reader with integrated antenna. Its extremely compact design makes it ideal for use on small assembly lines.

This reader has either

- an RS-422 interface with transmission procedure 3964R for connection to the RFID communication modules ASM 456, ASM 475, SIMATIC RF160C, RF170C, RF180C and RF182C,
- or a standardized IO-Link interface for connection to IO-Link master modules from Siemens or third parties.

Thanks to its high degree of protection and rugged design, the SIMATIC RF210R reader enables problem-free use even under the toughest industrial conditions. Connection is by means of either an 8-pin M12 plug-in connector (RS422 version) or a 4-pin M12 plug-in connector (IO-Link version).

The reader is operated with ISO 15693-compatible transponders.

**Design****Field data****Minimum distance from reader to reader**

SIMATIC RF210R ≥ 100 mm

**Technical specifications**

<b>Article No.</b>	<b>6GT2821-1AC32</b>
<b>Product-type designation</b>	<b>RF210R reader IO-Link</b>
<b>Suitability for installation</b>	ISO 15693 transponder, for connecting to IO-Link master
<b>Wireless frequencies</b>	
Operating frequency rated value	13.56 MHz
<b>Electrical data</b>	
Range maximum	20 mm
Protocol for radio transmission	ISO 15693, ISO 18000-3
Transfer rate with radio transmission maximum	26.5 kbit/s
Product property multitag-capable	No
Transmission rate at point-to-point connection serial maximum	38.4 kbit/s
Transmission time for user data	
• for write access per byte typical	-
• for read access per byte typical	40 ms
<b>Interfaces</b>	
Design of the electrical connection	M12, 4-pin
Standard for interfaces for communication	IO-Link
<b>Mechanical data</b>	
Material	Brass, nickel-plated / PBT
Color	Silver/pastel turquoise
Tightening torque of screw for mounting the equipment maximum	20 N·m
Mounting distance for metal surfaces recommended minimum	0 mm
<b>Supply voltage, current consumption, power loss</b>	
Supply voltage for DC	
• rated value	24 V
• minimum	20.4 V
• maximum	28.8 V
Consumed current at 24 V with DC typical	0.05 A
<b>Permitted ambient conditions</b>	
Ambient temperature	
• during operating	-20 ... +70 °C
• during storage	-25 ... +80 °C
• during transport	-25 ... +80 °C
Protection class IP	IP67
Resistance against shock	EN 60721-3-7, Class 7 M2
Resistance against shock	500 m/s <sup>2</sup>
Resistance against vibration	200 m/s <sup>2</sup>



## IO-Link

### RFID Systems

#### SIMATIC RF210R

##### Technical specifications (continued)

<b>Article No.</b>	<b>6GT2821-1AC32</b>
<b>Product-type designation</b>	<b>RF210R reader IO-Link</b>
<b>Design, dimensions and weight</b>	
Height	83 mm
Diameter	18 mm
Net weight	0.065 kg
Mounting type	2 x M18 nuts (included in scope of supply)
Cable length for RS 422 interface maximum	-
Cable length between master and IO-Link device maximum	20 m
<b>Product properties, functions, components general</b>	
Type of display	3-color LED
Product feature silicon-free	Yes
<b>Standards, specifications, approvals</b>	
Verification of suitability	Wireless according to R&TTE guidelines EN300 330 and EN 301489, FCC, UL/CSA

##### Ordering data

##### Article No.

<b>SIMATIC RF210R reader (IO-Link)</b>	<b>6GT2821-1AC32</b>
<b>Accessories</b>	
Note: All connection options can be found in Chapter 6 "Communication Modules".	
<b>IO-Link master</b> For SIMATIC ET 200eco PN, for 4 readers.	<b>6ES7148-6JA00-0AB0</b>
<b>IO-Link Master 4SI</b> For SIMATIC ET 200S, for 4 readers.	<b>6ES7138-4GA50-0AB0</b>
<b>IO-Link connecting cables</b>	
• between IO-Link master and reader, with M12 plug on the IO-Link master, open end, 4-pole, 5 m	<b>6GT2891-4LH50</b>
• between IO-Link master and reader, with M12 plug on the IO-Link master, open end, 4-pole, 10 m	<b>6GT2891-4LN10</b>
• between IO-Link master and reader, with M12 plug at both ends, 4-pole, 5 m	<b>6GT2891-0MH50</b>
• between IO-Link master and reader, with M12 plug at both ends, 4-pole, 10 m	<b>6GT2891-0MN10</b>
<b>DVD "RFID Systems Software &amp; Documentation"</b>	<b>6GT2080-2AA20</b>

##### More information

All current approvals can be found on the Internet at:

<http://www.siemens.com/rfid-approvals>

**Overview**

SIMATIC RF220R is an M30 reader with integrated antenna. Its compact design makes it ideal for use in small assembly lines which require a slightly higher range.

This reader has either

- an RS-422 interface with transmission procedure 3964R for connection to the RFID communication modules ASM 456, ASM 475, SIMATIC RF160C, RF170C, RF180C and RF182C,
- or a standardized IO-Link interface for connection to IO-Link master modules from Siemens or third parties.

Thanks to its high degree of protection and rugged design, the SIMATIC RF220R reader enables problem-free use even under the toughest industrial conditions. Connection is by means of either an 8-pin M12 plug-in connector (RS422 version) or a 4-pin M12 plug-in connector (IO-Link version).

The reader is operated with ISO 15693-compatible transponders.

**Design****Field data****Minimum distance from reader to reader**

SIMATIC RF220R ≥ 150 mm

**Technical specifications**

<b>Article No.</b>	<b>6GT2821-2AC32</b>
<b>Product-type designation</b>	<b>RF220R reader IO-Link</b>
<b>Suitability for installation</b>	ISO 15693 transponder, for connecting to IO-Link master
<b>Wireless frequencies</b>	
Operating frequency rated value	13.56 MHz
<b>Electrical data</b>	
Range maximum	35 mm
Protocol for radio transmission	ISO 15693, ISO 18000-3
Transfer rate with radio transmission maximum	26.5 kbit/s
Product property multitag-capable	No
Transmission rate at point-to-point connection serial maximum	38.4 kbit/s
Transmission time for user data	-
• for write access per byte typical	40 ms
• for read access per byte typical	
<b>Interfaces</b>	
Design of the electrical connection	M12, 4-pin
Standard for interfaces for communication	IO-Link
<b>Mechanical data</b>	
Material	Brass, nickel-plated / PBT
Color	Silver/pastel turquoise
Tightening torque of screw for mounting the equipment maximum	40 N·m
Mounting distance for metal surfaces recommended minimum	0 mm
<b>Supply voltage, current consumption, power loss</b>	
Supply voltage for DC	
• rated value	24 V
• minimum	20.4 V
• maximum	28.8 V
Consumed current at 24 V with DC typical	0.05 A
<b>Permitted ambient conditions</b>	
Ambient temperature	
• during operating	-20 ... +70 °C
• during storage	-25 ... +80 °C
• during transport	-25 ... +80 °C
Protection class IP	IP67
Resistance against shock	EN 60721-3-7, Class 7 M2
Resistance against shock	500 m/s <sup>2</sup>
Resistance against vibration	200 m/s <sup>2</sup>

## IO-Link

### RFID Systems

#### SIMATIC RF220R

##### Technical specifications (continued)

<b>Article No.</b>	<b>6GT2821-2AC32</b>
<b>Product-type designation</b>	<b>RF220R reader IO-Link</b>
<b>Design, dimensions and weight</b>	
Height	83 mm
Diameter	30 mm
Net weight	0.14 kg
Mounting type	2 x M30 nuts (included in scope of supply)
Cable length	-
• for RS 422 interface maximum	-
• between master and IO-Link device maximum	20 m
<b>Product properties, functions, components general</b>	
Type of display	3-color LED
Product feature silicon-free	Yes
<b>Standards, specifications, approvals</b>	
Verification of suitability	Wireless according to R&TTE guidelines EN300 330 and EN 301489, FCC, UL/CSA

##### Ordering data

##### Article No.

<b>SIMATIC RF220R reader (IO-Link)</b>	<b>6GT2821-2AC32</b>
<i>Accessories</i>	
Note: All connection options can be found in Chapter 6 "Communication Modules".	
<b>IO-Link master</b> For SIMATIC ET 200eco PN, for 4 readers.	<b>6ES7148-6JA00-0AB0</b>
<b>IO-Link Master 4SI</b> For SIMATIC ET 200S, for 4 readers.	<b>6ES7138-4GA50-0AB0</b>
<b>IO-Link connecting cables</b>	
• between IO-Link master and reader, with M12 plug on the IO-Link master, open end, 4-pole, 5 m	<b>6GT2891-4LH50</b>
• between IO-Link master and reader, with M12 plug on the IO-Link master, open end, 4-pole, 10 m	<b>6GT2891-4LN10</b>
• between IO-Link master and reader, with M12 plug at both ends, 4-pole, 5 m	<b>6GT2891-0MH50</b>
• between IO-Link master and reader, with M12 plug at both ends, 4-pole, 10 m	<b>6GT2891-0MN10</b>
<b>DVD "RFID Systems Software &amp; Documentation"</b>	<b>6GT2080-2AA20</b>

##### More information

All current approvals can be found on the Internet at:

<http://www.siemens.com/rfid-approvals>

## Overview



SIMATIC RF260R is a reader with an integrated antenna. Its compact design makes it ideal for use in assembly lines.

This reader has either:

- An RS-422 interface with transmission procedure 3964R for connection to the RFID communication modules ASM 456, ASM 475, SIMATIC RF160C, RF170C, RF180C and RF182C,
- or an RS232 interface with a 3964R transmission procedure or ASCII protocol for connection to S7-1200, PC-based systems or third-party controllers,
- or a standardized IO-Link interface for connection to IO-Link master modules from Siemens or third parties.

Thanks to its high degree of protection and rugged design, the SIMATIC RF260R reader enables problem-free use even under the toughest industrial conditions. Connection is by means of either an 8-pin M12 plug-in connector (RS422/RS232 version) or a 4-pin M12 plug-in connector (IO-Link version).

The reader is operated with ISO 15693-compatible transponders.

## Design

## Field data

## Minimum distance from reader to reader

SIMATIC RF260R	≥ 150 mm
----------------	----------

## Technical specifications

<b>Article No.</b>	<b>6GT2821-6AC32</b>
<b>Product-type designation</b>	<b>RF260R reader IO-Link</b>
<b>Suitability for installation</b>	ISO 15693 transponder, for connecting to IO-Link master
<b>Wireless frequencies</b>	
Operating frequency rated value	13.56 MHz
<b>Electrical data</b>	
Range maximum	135 mm
Protocol for radio transmission	ISO 15693, ISO 18000-3
Transfer rate with radio transmission maximum	26.5 kbit/s
Product property multitag-capable	No
Transmission rate at point-to-point connection serial maximum	38.4 kbit/s
Transmission time for user data	
• for write access per byte typical	-
• for read access per byte typical	40 ms
<b>Interfaces</b>	
Design of the electrical connection	M12, 4-pin
Standard for interfaces for communication	IO-Link
<b>Mechanical data</b>	
Material	PA6.6
Color	Anthracite
Tightening torque of screw for mounting the equipment maximum	1.5 N·m
Mounting distance for metal surfaces recommended minimum	0 mm
<b>Supply voltage, current consumption, power loss</b>	
Supply voltage for DC	
• rated value	24 V
• minimum	20.4 V
• maximum	28.8 V
Consumed current at 24 V with DC typical	0.05 A
<b>Permitted ambient conditions</b>	
Ambient temperature	
• during operating	-20 ... +70 °C
• during storage	-25 ... +80 °C
• during transport	-25 ... +80 °C
Protection class IP	IP67
Resistance against shock	EN 60721-3-7, Class 7 M2
Resistance against shock	500 m/s <sup>2</sup>
Resistance against vibration	200 m/s <sup>2</sup>

## IO-Link RFID Systems

### SIMATIC RF260R

#### Technical specifications (continued)

<b>Article No.</b>	<b>6GT2821-6AC32</b>
<b>Product-type designation</b>	<b>RF260R reader IO-Link</b>
<b>Design, dimensions and weight</b>	
Width	75 mm
Height	41 mm
Depth	75 mm
Diameter	-
Net weight	0.2 kg
Mounting type	2 x M5 screws
Cable length	-
• with RS 232 interface maximum	-
• for RS 422 interface maximum	-
Cable length between master and IO-Link device maximum	20 m
<b>Product properties, functions, components general</b>	
Type of display	3-color LED
Product feature silicon-free	Yes
<b>Standards, specifications, approvals</b>	
Verification of suitability	Wireless according to R&TTE guidelines EN300 330 and EN 301489, FCC, UL/CSA

#### Ordering data

#### Article No.

<b>SIMATIC RF260R reader (IO-Link)</b>	<b>6GT2821-6AC32</b>
<b>Accessories</b>	
Note: All connection options can be found in Chapter 6 "Communication Modules".	
<b>RS232 connecting cables</b>	
Between reader and PC (RS232), 5 m long, material: PUR, CMG approval.	
• 24 V connection with M12 plug	<b>6GT2891-4KH50</b>
• 24 V connection with open ends	<b>6GT2891-4KH50-0AX0</b>
<b>IO-Link master</b>	
For SIMATIC ET 200eco PN, for 4 readers	<b>6ES7148-6JA00-0AB0</b>
<b>IO-Link Master 4SI</b>	
For SIMATIC ET 200S, for 4 readers	<b>6ES7138-4GA50-0AB0</b>
<b>IO-Link connecting cables</b>	
• between IO-Link master and reader, with M12 plug on the IO-Link master, open end, 4-pole, 5 m	<b>6GT2891-4LH50</b>
• between IO-Link master and reader, with M12 plug on the IO-Link master, open end, 4-pole, 10 m	<b>6GT2891-4LN10</b>
• between IO-Link master and reader, with M12 plug at both ends, 4-pole, 5 m	<b>6GT2891-0MH50</b>
• between IO-Link master and reader, with M12 plug at both ends, 4-pole, 10 m	<b>6GT2891-0MN10</b>
<b>DVD "RFID Systems Software &amp; Documentation"</b>	<b>6GT2080-2AA20</b>

#### More information

All current approvals can be found on the Internet at:

<http://www.siemens.com/rfid-approvals>